



## SUNNY BOY STORAGE 3.7 / 5.0 / 6.0

## Important information

Depending on availability, the product is or is not equipped with Wi-Fi functionality. The reason for this is the currently problematic semiconductor supply, caused by the COVID-19 pandemic.

If the product is not equipped with Wi-Fi functionality, please use the standard Ethernet communication interface included for commissioning, configuration and integrating the product into a network.

If integrating the product into a Wi-Fi network is absolutely necessary, this can be done using a commercial Wi-Fi repeater, which is connected to the product via Ethernet.

Without the Wi-Fi function, a direct connection to the user interface by scanning the QR code on the product with the SMA 360° app is not possible. Use a different type of connection.

## Legal Provisions

The information contained in these documents is the property of SMA Solar Technology AG. No part of this document may be reproduced, stored in a retrieval system, or transmitted, in any form or by any means, be it electronic, mechanical, photographic, magnetic or otherwise, without the prior written permission of SMA Solar Technology AG. Internal reproduction used solely for the purpose of product evaluation or other proper use is allowed and does not require prior approval.

SMA Solar Technology AG makes no representations or warranties, express or implied, with respect to this documentation or any of the equipment and/or software it may describe, including (with no limitation) any implied warranties of utility, merchantability, or fitness for any particular purpose. All such representations or warranties are expressly disclaimed. Neither SMA Solar Technology AG nor its distributors or dealers shall be liable for any indirect, incidental, or consequential damages under any circumstances.

The exclusion of implied warranties may not apply in all cases under some statutes, and thus the above exclusion may not apply.

Specifications are subject to change without notice. Every attempt has been made to make this document complete, accurate and up-to-date. Readers are cautioned, however, that product improvements and field usage experience may cause SMA Solar Technology AG to make changes to these specifications without advance notice or per contract provisions. SMA Solar Technology AG shall not be responsible for any damages, including indirect, incidental or consequential damages, caused by reliance on the material presented, including, but not limited to, omissions, typographical errors, arithmetical errors or listing errors in the content material.

### SMA Warranty

You can download the current warranty conditions from the Internet at [www.SMA-Solar.com](http://www.SMA-Solar.com).

### Software licenses

The licenses for the installed software modules (open source) can be found in the user interface of the product.

### Trademarks

All trademarks are recognized, even if not explicitly identified as such. Missing designations do not mean that a product or brand is not a registered trademark.

### SMA Solar Technology AG

Sonnenallee 1

34266 Niestetal

Germany

Phone +49 561 9522-0

Fax +49 561 9522 100

[www.SMA.de](http://www.SMA.de)

E-mail: [info@SMA.de](mailto:info@SMA.de)

Status: 3/24/2022

Copyright © 2022 SMA Solar Technology AG. All rights reserved.

# Table of Contents

<b>1</b>	<b>Information on this Document .....</b>	<b>7</b>
1.1	Validity .....	7
1.2	Target Group .....	7
1.3	Content and Structure of this Document .....	7
1.4	Levels of warning messages .....	7
1.5	Symbols in the Document .....	8
1.6	Typographical Elements in the Document .....	8
1.7	Designations in the Document .....	9
1.8	Additional Information .....	9
<b>2</b>	<b>Safety .....</b>	<b>10</b>
2.1	Intended Use .....	10
2.2	IMPORTANT SAFETY INSTRUCTIONS.....	11
<b>3</b>	<b>Scope of Delivery .....</b>	<b>16</b>
<b>4</b>	<b>Product Overview .....</b>	<b>18</b>
4.1	Product Description .....	18
4.2	Symbols on the Product .....	20
4.3	Interfaces and Functions .....	21
4.4	LED Signals.....	27
4.5	System Overview .....	29
4.5.1	Circuitry Overview.....	30
4.5.1.1	System with secure power supply .....	30
4.5.1.2	System with battery-backup function .....	31
4.5.2	Communication Overview .....	32
4.6	"Battery Management" .....	33
4.6.1	Battery Use by Systems for Increased Self-Consumption.....	33
4.6.2	Battery Use by Battery-Backup Systems with Increased Self-Consumption .....	34
<b>5</b>	<b>Mounting.....</b>	<b>36</b>
5.1	Requirements for Mounting .....	36
5.2	Mounting the product .....	39
<b>6</b>	<b>Electrical Connection .....</b>	<b>43</b>
6.1	Overview of the Connection Area .....	43
6.1.1	View from Below.....	43
6.1.2	Interior View .....	44
6.2	Grounding .....	45

6.2.1	Overview of Grounding Connection .....	45
6.2.2	Requirements for Battery Inverter Grounding Cable .....	45
6.3	AC Connection .....	46
6.3.1	Requirements for the AC Connection .....	46
6.3.2	Connecting the Inverter to the Utility Grid .....	47
6.3.3	Connecting Additional Grounding .....	49
6.4	Connecting the Network Cables .....	51
6.5	Connecting the energy meter .....	52
6.6	Connecting CAN communication cable .....	53
6.7	Connecting the switch and outlet for secure power supply operation .....	55
6.8	Connecting Switch for black start (in battery-backup systems) .....	59
6.9	DC Connection .....	60
6.9.1	Possible Connection .....	60
6.9.1.1	Connection of batteries with a charging/discharging current limit of 10 A .....	61
6.9.1.2	Connection of two batteries with different charging/discharging currents .....	62
6.9.1.3	Connection of one battery with a charging/discharging current limit of 20 A .....	62
6.9.1.4	Connection of a battery with a charging/discharging current limit of 30 A .....	63
6.9.2	Requirements for the DC Connection .....	63
6.9.3	Connecting the power cable of the battery .....	64
<b>7</b>	<b>Commissioning .....</b>	<b>66</b>
7.1	Commissioning Procedure .....	66
7.2	Commissioning the Inverter .....	67
7.3	Selecting a configuration option .....	69
<b>8</b>	<b>Operation .....</b>	<b>72</b>
8.1	Establishing a connection to the user interface .....	72
8.1.1	Establishing a Direct Connection via Ethernet .....	72
8.1.2	Establishing a direct connection via WLAN .....	72
8.1.3	Establishing a Connection via Ethernet in the local network .....	74
8.1.4	Establishing a Connection via WLAN in the Local Network .....	75
8.2	Logging In and Out of the User Interface .....	76
8.3	Start Page Design of the User Interface .....	78
8.4	Displaying and Downloading the Stored Data .....	81
8.5	Starting the Installation Assistant .....	82
8.6	Secure power supply operation .....	83
8.6.1	Enable secure power supply operation .....	84
8.6.2	Disable secure power supply operation .....	84

8.7	Checking or Disabling Battery-Backup Operation.....	84
8.8	Activate WPS Function.....	85
8.9	Switching WLAN On and Off.....	85
8.10	Changing the Password.....	86
8.11	Changing Operating Parameters.....	86
8.12	Configuring the Country Data Set.....	88
8.13	Configuring the Active Power Mode.....	88
8.14	Configuring Battery and Automatic Transfer Switching Device.....	89
8.15	Disabling Battery Charging by PV System in Battery-Backup Operation Mode ...	90
8.16	Configuring the Modbus Function.....	90
8.17	Activating the Receipt of Control Signals (Only for Italy).....	91
8.18	Deactivating Grounding Conductor Monitoring.....	91
8.19	Configuring the Energy Meter.....	92
8.20	Saving the Configuration in a File.....	92
8.21	Adopting a Configuration from a File.....	92
8.22	Firmware Update.....	93
8.22.1	Activating Automatic Firmware Update.....	93
8.22.2	Updating Firmware with Update File via the User Interface.....	94
8.22.3	Updating Firmware with Update File via the USB Flash Drive.....	94
8.22.4	Searching for and Installing New Firmware via the User Interface....	95
<b>9</b>	<b>Disconnecting the Inverter from Voltage Sources.....</b>	<b>96</b>
<b>10</b>	<b>Clean the product.....</b>	<b>97</b>
<b>11</b>	<b>Troubleshooting.....</b>	<b>98</b>
11.1	Forgotten Password.....	98
11.2	Event Messages.....	99
11.3	Problems with streaming services.....	135
<b>12</b>	<b>Decommissioning the Inverter.....</b>	<b>136</b>
<b>13</b>	<b>Procedure for Receiving a Replacement Device.....</b>	<b>139</b>
<b>14</b>	<b>Technical Data.....</b>	<b>141</b>
<b>15</b>	<b>Contact.....</b>	<b>146</b>
<b>16</b>	<b>EU Declaration of Conformity.....</b>	<b>147</b>
<b>17</b>	<b>UK Declaration of Conformity.....</b>	<b>148</b>

# 1 Information on this Document

## 1.1 Validity

This document is valid for:

- SBS3.7-10 (Sunny Boy Storage 3.7) from firmware version  $\geq$  3.00.00.R
- SBS5.0-10 (Sunny Boy Storage 5.0) from firmware version  $\geq$  3.00.00.R
- SBS6.0-10 (Sunny Boy Storage 6.0) from firmware version  $\geq$  3.00.00.R

## 1.2 Target Group

This document is intended for qualified persons and end users. Only qualified persons are allowed to perform the activities marked in this document with a warning symbol and the caption "Qualified person". Tasks that do not require any particular qualification are not marked and can also be performed by end users. Qualified persons must have the following skills:

- Knowledge of how batteries work and are operated
- Training in how to deal with the dangers and risks associated with installing, repairing and using electrical devices, batteries and installations
- Training in the installation and commissioning of electrical devices and installations
- Knowledge of all applicable laws, standards and directives
- Knowledge of and compliance with this document and all safety information
- Knowledge of and compliance with the documents of the battery manufacturer with all safety information

## 1.3 Content and Structure of this Document

This document describes the mounting, installation, commissioning, configuration, operation, troubleshooting and decommissioning of the product as well as the operation of the product user interface.

You will find the latest version of this document and further information on the product in PDF format and as eManual at [www.SMA-Solar.com](http://www.SMA-Solar.com). You can also call up the eManual via the user interface of the product.

Illustrations in this document are reduced to the essential information and may deviate from the real product.

## 1.4 Levels of warning messages

The following levels of warning messages may occur when handling the product.

### DANGER

Indicates a hazardous situation which, if not avoided, will result in death or serious injury.

### WARNING

Indicates a hazardous situation which, if not avoided, could result in death or serious injury.



**⚠ CAUTION**

Indicates a hazardous situation which, if not avoided, could result in minor or moderate injury.

**NOTICE**

Indicates a situation which, if not avoided, can result in property damage.

## 1.5 Symbols in the Document

Icon	Explanation
	Information that is important for a specific topic or goal, but is not safety-relevant
<input type="checkbox"/>	Indicates a requirement for meeting a specific goal
<input checked="" type="checkbox"/>	Desired result
<b>×</b>	A problem that might occur.
	Example
<b>⚠ QUALIFIED PERSON</b>	Sections describing activities to be performed by qualified persons only

## 1.6 Typographical Elements in the Document

Typographical element	Use	Example
<b>bold</b>	<ul style="list-style-type: none"> <li>Messages</li> <li>Terminals</li> <li>Elements on a user interface</li> <li>Elements to be selected</li> <li>Elements to be entered</li> </ul>	<ul style="list-style-type: none"> <li>Connect the insulated conductors to the terminals <b>X703:1</b> to <b>X703:6</b>.</li> <li>Enter <b>10</b> in the field <b>Minutes</b>.</li> </ul>
>	<ul style="list-style-type: none"> <li>Connects several elements to be selected</li> </ul>	<ul style="list-style-type: none"> <li>Go to <b>Settings &gt; Date</b>.</li> </ul>
[Button] [Key]	<ul style="list-style-type: none"> <li>Button or key to be clicked on or pressed down</li> </ul>	<ul style="list-style-type: none"> <li>Select <b>[Enter]</b>.</li> </ul>
#	<ul style="list-style-type: none"> <li>Placeholder for variable components (e.g., parameter names)</li> </ul>	<ul style="list-style-type: none"> <li>Parameter <b>WCtHz.Hz#</b></li> </ul>



## 1.7 Designations in the Document

Complete designation	Designation in this document
Sunny Boy Storage	Inverter, product

## 1.8 Additional Information

For more information, please go to [www.SMA-Solar.com](http://www.SMA-Solar.com).

Title and information content	Type of information
"Approved batteries and battery communication connection" Overview of approved batteries	Technical Information
"SMA Smart Home" The System Solution for Greater Independence	Planning Guidelines
"SMA GRID GUARD 10.0 - Grid Management Services via Inverter and System Controller"	Technical Information
"Efficiency and Derating" Efficiency and derating behavior of the SMA inverters	Technical Information
"Parameters and Measured Values" Overview of all inverter operating parameters and their configuration options	Technical Information
"SMA and SunSpec Modbus® Interface" Information on the Modbus interface	Technical Information
"Modbus® parameters and measured values" Device-specific list of the Modbus register	Technical Information
"SMA SPEEDWIRE FIELDBUS"	Technical information

## 2 Safety

### 2.1 Intended Use

The Sunny Boy Storage is an AC-coupled battery inverter for parallel grid and stand-alone mode operation. The Sunny Boy Storage converts the direct current supplied by a battery into grid-compliant alternating current. The Sunny Boy Storage, together with a battery and a compatible energy meter, make up a system for increased self-consumption (Flexible Storage System) or, together with an automatic transfer switching device compatible with Sunny Boy Storage, a battery-backup system (Flexible Storage System with battery-backup function).

The product must only be used as stationary equipment.

The product is suitable for indoor and outdoor use.

The product must only be operated in connection with an intrinsically safe lithium-ion battery approved by SMA Solar Technology AG. An updated list of batteries approved by SMA Solar Technology AG is available at [www.SMA-Solar.com](http://www.SMA-Solar.com).

The battery must comply with the locally applicable standards and directives and must be intrinsically safe (see technical information "SMA Flexible Storage System - Detailed explanations of the safety concept" for detailed explanations regarding the safety concept of battery inverters by SMA Solar Technology AG).

The communication interface of the battery used must be compatible with the product. The entire battery voltage range must be completely within the permissible input voltage range of the product. The maximum permissible DC input voltage of the product must not be exceeded.

The product is not suitable for supplying life-sustaining medical devices. A power outage must not lead to personal injury.

All components must remain within their permitted operating ranges and their installation requirements at all times.

The product must only be used in countries for which it is approved or released by SMA Solar Technology AG and the grid operator.

The product may only be operated with one of the energy meters approved by SMA Solar Technology AG. The following energy meters are allowed to be used when operating this product:

- EMETER-20 (SMA Energy Meter)
- HM-20 (Sunny Home Manager 2.0)

The product may only be operated in battery-backup systems using an automatic transfer switching device approved by SMA Solar Technology AG. You are not allowed to build automatic transfer switching devices for operation with this product by yourself on the basis of a circuit diagram.

The following automatic transfer switching devices are allowed to be used when operating this product:

- 10012856\_V1.4 (3PH automatic transfer switching device for SMA Sunny Boy Storage) from enwitec electronic GmbH & Co.KG
- For Italy only: 10013490\_V1.0 (1PH Battery Backup-Distribution for 1 x Sunny Boy Storage) from enwitec electronic GmbH & Co.KG
- For Italy only: 10013491\_V1.0 (3PH automatic transfer switching device for SMA Sunny Boy Storage) from enwitec electronic GmbH & Co.KG

- For Australia only: SBS-ABU-63.1-AU-10 (Automatic Backup Unit) from SMA Solar Technology AG

Use SMA products only in accordance with the information provided in the enclosed documentation and with the locally applicable laws, regulations, standards and directives. Any other application may cause personal injury or property damage.

Alterations to the SMA products, e.g., changes or modifications, are only permitted with the express written permission of SMA Solar Technology AG. Unauthorized alterations will void guarantee and warranty claims and in most cases terminate the operating license. SMA Solar Technology AG shall not be held liable for any damage caused by such changes.

Any use of the product other than that described in the Intended Use section does not qualify as appropriate.

The enclosed documentation is an integral part of this product. Keep the documentation in a convenient, dry place for future reference and observe all instructions contained therein.

This document does not replace any regional, state, provincial, federal or national laws, regulations or standards that apply to the installation, electrical safety and use of the product. SMA Solar Technology AG assumes no responsibility for the compliance or non-compliance with such laws or codes in connection with the installation of the product.

The type label must remain permanently attached to the product.

## 2.2 IMPORTANT SAFETY INSTRUCTIONS

Keep the manual for future reference.

This section contains safety information that must be observed at all times when working.

The product has been designed and tested in accordance with international safety requirements. As with all electrical or electronic devices, there are residual risks despite careful construction. To prevent personal injury and property damage and to ensure long-term operation of the product, read this section carefully and observe all safety information at all times.

### DANGER

#### **Danger to life due to electric shock when live components or cables of the inverter are touched**

High voltages are present in the conductive components or cables of the inverter. Touching live parts and cables of the inverter results in death or lethal injuries due to electric shock.

- Disconnect the product and battery from voltage sources and make sure it cannot be reconnected before working on the device.
- Wear suitable personal protective equipment for all work on the product.
- Do not touch non-insulated parts or cables.

** DANGER****Danger to life due to electric shock when live components or DC cables are touched**

The DC cables connected to a battery may be live. Touching live DC cables results in death or serious injury due to electric shock.

- Disconnect the product and battery from voltage sources and make sure it cannot be reconnected before working on the device.
- Wait five minutes before working on the inverter.
- Observe all safety information of the battery manufacturer.
- Do not touch non-insulated parts or cables.
- Do not remove the terminal block with the connected DC conductors from the slot under load.
- Wear suitable personal protective equipment for all work on the product.

** DANGER****Danger to life due to electric shock in case of overvoltages and if surge protection is missing**

Overvoltages (e. g. in the event of a flash of lightning) can be further conducted into the building and to other connected devices in the same network via the network cables or other data cables if there is no surge protection. Touching live parts and cables results in death or lethal injuries due to electric shock.

- Ensure that all devices in the same network and the battery are integrated into the existing surge protection.
- When laying the network cables or other data cables outdoors, it must be ensured that a suitable surge protection device is provided at the transition point of the cable from the product or the battery outdoors to the inside of a building.
- The Ethernet interface of the product is classified as "TNV-1" and offers protection against overvoltages of up to 1.5 kV.

**⚠ WARNING****Danger to life due to fire and explosion**

In rare cases, an explosive gas mixture can be generated inside the product under fault conditions. In this state, switching operations can cause a fire inside the product or explosion. Death or lethal injuries due to hot or flying debris can result.

- In the event of a fault, do not perform any direct actions on the product.
- Ensure that unauthorized persons have no access to the product.
- Disconnect the battery from the product via an external disconnection device.
- Disconnect the AC circuit breaker, or keep it disconnected in case it has already tripped, and secure it against reconnection.
- Only perform work on the product (e.g., troubleshooting, repair work) when wearing personal protective equipment for handling of hazardous substances (e.g., safety gloves, eye and face protection, respiratory protection).

**⚠ WARNING****Risk of injury due to toxic substances, gases and dusts.**

In rare cases, damages to electronic components can result in the formation of toxic substances, gases or dusts inside the product. Touching toxic substances and inhaling toxic gases and dusts can cause skin irritation, burns or poisoning, trouble breathing and nausea.

- Only perform work on the product (e.g., troubleshooting, repair work) when wearing personal protective equipment for handling of hazardous substances (e.g., safety gloves, eye and face protection, respiratory protection).
- Ensure that unauthorized persons have no access to the product.

**⚠ WARNING****Danger to life due to fire or explosion when batteries are fully discharged**

A fire may occur due to incorrect charging of fully discharged batteries. This can result in death or serious injury.

- Before commissioning the system, verify that the battery is not fully discharged.
- Do not commission the system if the battery is fully discharged.
- If the battery is fully discharged, contact the battery manufacturer for further proceedings.
- Only charge fully discharged batteries as instructed by the battery manufacturer.

**⚠ WARNING****Danger to life due to burns caused by electric arcs through short-circuit currents**

Short-circuit currents in the battery can cause heat build-up and electric arcs. Heat build-up and electric arcs may result in lethal injuries due to burns.

- Disconnect the battery from all voltages sources prior to performing any work on the battery.
- Observe all safety information of the battery manufacturer.

**⚠ WARNING****Danger to life due to electric shock from destruction of the measuring device due to overvoltage**

Overvoltage can damage a measuring device and result in voltage being present in the enclosure of the measuring device. Touching the live enclosure of the measuring device results in death or lethal injuries due to electric shock.

- Only use measuring devices with a DC input voltage range of 600 V or higher.

**⚠ CAUTION****Risk of burns from hot surfaces**

The surface of the inverter can get very hot. Touching the surface can result in burns.

- Mount the inverter in such a way that it cannot be touched inadvertently.
- Do not touch hot surfaces.
- Wait 30 minutes for the surface to cool sufficiently.
- Observe the safety messages on the inverter.

**⚠ CAUTION****Risk of injury due to weight of product**

Injuries may result if the product is lifted incorrectly or dropped while being transported or mounted.

- Transport and lift the product carefully. Take the weight of the product into account.
- Wear suitable personal protective equipment for all work on the product.

**NOTICE****Damage to the enclosure seal in subfreezing conditions**

If you open the product or disconnect the Power Unit and Connection Unit when temperatures are below freezing, the enclosure seals can be damaged. Moisture can penetrate the product and damage it.

- Only open the product if the ambient temperature is not below 0 °C.
- If a layer of ice has formed on the enclosure seal when temperatures are below freezing, remove it prior to opening the product (e.g. by melting the ice with warm air).
- Do not disassemble the Power Unit and Connection Unit unless the ambient temperature is at least 0 °C and conditions are frost-free.

**NOTICE****Damage to the product due to sand, dust and moisture ingress**

Sand, dust and moisture penetration can damage the product and impair its functionality.

- Only open the product if the humidity is within the thresholds and the environment is free of sand and dust.
- Do not open the product during a dust storm or precipitation.

**NOTICE****Damage to the inverter due to electrostatic discharge**

Touching electronic components can cause damage to or destroy the inverter through electrostatic discharge.

- Ground yourself before touching any component.

**NOTICE****Damage to the product due to cleaning agents**

The use of cleaning agents may cause damage to the product and its components.

- Clean the product and all its components only with a cloth moistened with clear water.

**i** **Change to the names and units of grid parameters to comply with the grid-connection requirements in accordance with Regulation (EU) 2016/631 (valid from April 27, 2019)**

To comply with the EU grid-connection requirements (valid from April 27, 2019) the names and units of grid parameters were changed. This change is valid from firmware version  $\geq 3.00.00.R$  if a country data set for fulfilling the EU grid-connection requirements (valid from 2019-04-27) is set. Names and units of grid parameters for inverters with firmware version  $\leq 2.99.99.R$  are not affected by this change and remain valid. This also applies from firmware version  $\geq 3.00.00.R$  if a country data set that is valid for countries outside the EU is set.

### 3 Scope of Delivery

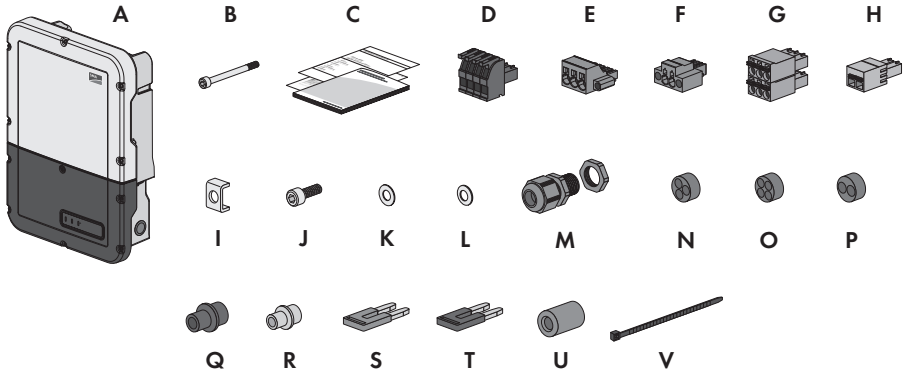

Figure 1: Components included in the scope of delivery

Position	Quantity	Designation
A	1	Inverter
B	1	Hexagon socket cap head screw M5 x 60 (not required)
C	1	Quick reference guide with password label on the rear side The label contains the following information: <ul style="list-style-type: none"> <li>• PIC (Product Identification Code) identification key for registering the system in Sunny Portal</li> <li>• RID (Registration Identifier) registration ID for registering the system in Sunny Portal</li> <li>• WLAN password WPA2-PSK (WiFi Protected Access 2 - Preshared Key) for direct connection to the inverter via WLAN</li> </ul>
D	1	4-pole terminal block for connecting a RS485 energy meter
E	1	Terminal block for the AC connection
F	1	Terminal block for connecting the outlet for secure power supply operation
G	4	6-pole terminal block for connecting the CAN battery communication cables and the CAN communication cable of the automatic transfer switching device
H	1	2-pole terminal block for the switch connection for secure power supply operation or for black start function.
I	5	Clamping bracket
J	5	Cylindrical screw M5 x 16
K	1	Washer M5



Position	Quantity	Designation
L	5	Spring washer M5
M	6	Cable gland and counter nut PG 21
N	2	Three-hole cable support sleeve
O	4	Four-hole cable support sleeve
P	1	Two-hole cable support sleeve
Q	6	Sealing plug for two-hole and three-hole cable support sleeve
R	6	Sealing plug for four-hole cable support sleeve
S	2	Blue jumper
T	2	Red jumper
U	1	Ferrite
V	1	Cable tie

## 4 Product Overview

### 4.1 Product Description

The Sunny Boy Storage uses the connected battery for the intermediate storage of excess PV energy in the SMA Flexible Storage System. For this purpose, the Sunny Boy Storage receives the feed-in and purchased energy data from the energy meter. This data is used by the Sunny Boy Storage to control the charging and discharging of the battery.

The use of an automatic transfer switching device is required in the battery-backup system. In the event of grid failure, the automatic transfer switching device disconnects the PV system, loads and the Sunny Boy Storage from the utility grid and creates a battery-backup grid. The battery-backup grid supplies loads that should continue to be supplied with electricity in the event of grid failure. In the event of grid failure, the Sunny Boy Storage supplies the loads with energy after a short switching time. The PV system supplies additional energy that can be used to supply the loads and charge the battery.

The use of an automatic transfer switching device is not required in limited battery-backup systems. To build a limited battery-backup system, you must attach an outlet and a switch to the inverter. You can connect a load to the outlet, which should continue to be supplied with power from the battery in the event of grid failure. The secure power supply operation is not automatically enabled in the event of a grid failure, neither is it automatically disabled once the utility grid is available again. During secure power supply operation, the load can only be supplied with energy as long as there is stored energy available in the battery.

#### **Secure power supply operation in Flexible Storage Systems with backup power supply not possible**

If the inverter is used in a battery-backup system and connected with an automatic transfer switch, the secure power supply operation is not available.

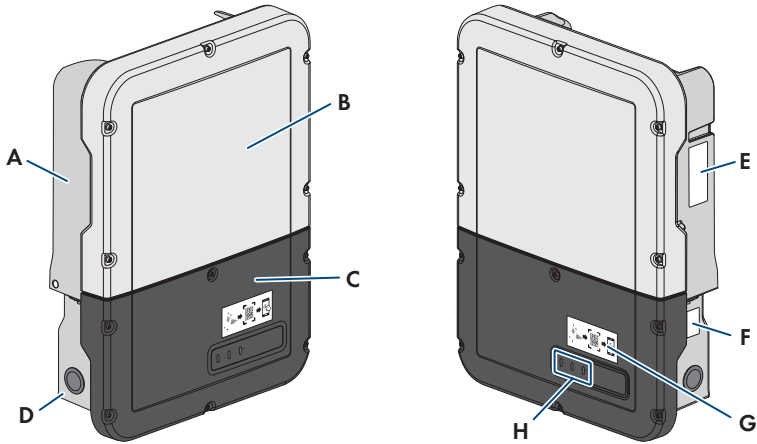



















Figure 2: Design of the inverter

Position	Designation
A	Power Unit
B	Enclosure lid of the Power Unit
C	Enclosure lid for the Connection Unit
D	Connection Unit
E	Type label The type label uniquely identifies the inverter. The type label must remain permanently attached to the product. You will find the following information on the type label: <ul style="list-style-type: none"> <li>• Inverter device type (Model)</li> <li>• Serial number of the Power Unit (Serial No. Power Unit or S/N Power Unit)</li> <li>• Date of manufacture</li> <li>• Device-specific characteristics</li> </ul>
F	Additional type label The additional type label must remain permanently attached to the product. You will find the following information on the additional type label: <ul style="list-style-type: none"> <li>• Device type (Model)</li> <li>• Inverter serial number (Serial number device or S/N device)</li> <li>• Identification key (PIC) for registration in Sunny Portal</li> <li>• Registration ID (RID) for registration in Sunny Portal</li> <li>• WLAN password (WPA2-PSK) for the direct connection to the user interface of the inverter via WLAN</li> </ul>

Position	Designation
G	Label with QR Code for scanning via the SMA 360° App and easy connection to the inverter's user interface via Wi-Fi (only available if the product is equipped with a Wi-Fi interface)
H	LEDs The LEDs indicate the operating state of the product.

## 4.2 Symbols on the Product

Icon	Explanation
	Beware of a danger zone This symbol indicates that the product must be additionally grounded if additional grounding or equipotential bonding is required at the installation site.
	Beware of electrical voltage The product operates at high voltages.
	Beware of hot surface The product can get hot during operation.
	Danger to life due to high voltages in the inverter; observe a waiting time of 5 minutes. High voltages that can cause lethal electric shocks are present in the live components of the inverter. Prior to performing any work on the inverter, disconnect it from all voltage sources as described in this document.
	Observe the documentations Observe all documentations supplied with the product.
	Inverter Together with the green LED, this symbol indicates the operating state of the inverter.
	Observe the documentations Together with the red LED, this symbol indicates an error.
	Data transmission Together with the blue LED, this symbol indicates the status of the network connection.

Icon	Explanation
	Grounding conductor This symbol indicates the position for connecting a grounding conductor.
	Alternating current
	Direct current
	The product has no galvanic isolation.
	WEEE designation Do not dispose of the product together with the household waste but in accordance with the disposal regulations for electronic waste applicable at the installation site.
	The product is suitable for outdoor installation.
<b>IP65</b>	Degree of protection IP65 The product is protected against the penetration of dust and water that is directed as a jet against the enclosure from all directions.
	CE marking The product complies with the requirements of the applicable EU directives.
	UKCA marking The product complies with the regulations of the applicable laws of England, Wales and Scotland.
	RoHS labeling The product complies with the requirements of the applicable EU directives.
	RCM (Regulatory Compliance Mark) The product complies with the requirements of the applicable Australian standards.

### 4.3 Interfaces and Functions

The inverter can be equipped or retrofitted with the following interfaces and functions:

## User interface for configuration and monitoring

The product is equipped as standard with an integrated webserver, which provides a user interface for configuring and monitoring the product.

Once the connection has been established to the smart device, use a terminal (e.g. smartphone, tablet or laptop) to connect to the product's user interface using a web browser.

### Smart Inverter Screen

The Smart Inverter Screen enables you to view the status display and to display the nominal energy throughput and state of charge of the battery on the user interface login page. You therefore have an overview of the most important inverter and battery data without having to log into the user interface.

The Smart Inverter Screen is deactivated by default. The Smart Inverter Screen can be activated via the user interface once the inverter has been commissioned.

### SMA Speedwire

The product is equipped with SMA Speedwire as standard. SMA Speedwire is a type of communication based on the Ethernet standard. SMA Speedwire is designed for a data transfer rate of 100 Mbps and enables optimum communication between Speedwire devices within systems.

The products supports the encrypted system communication with SMA Speedwire Encrypted Communication. In order to be able to use the Speedwire encryption in the system, all Speedwire devices, except for the SMA Energy Meter, must support the function SMA Speedwire Encrypted Communication.

### SMA Webconnect

The product is equipped with a Webconnect function as standard. The Webconnect function enables direct data transmission between the product and Internet portals Sunny Portal and Sunny Places without any additional communication device and for a maximum of 1 products per visualized system. In PV systems with more than 1 products, there is the option of establishing data transmission between the products and Sunny Portal via the data logger (e.g., SMA Data Manager) or distributing the inverters over several systems. If there is an existing Wi-Fi or Ethernet connection, you can directly access your visualized system via the web browser on your smart device (e.g. smartphone, tablet or laptop).

### WLAN connection to SMA 360° app

There is a QR code on the product by default. If the product is equipped with a Wi-Fi interface, you can access the product via Wi-Fi by scanning the QR code on the product using the SMA 360° or SMA Energy app. This automatically connects to the user interface.

### Wi-Fi

Depending on availability, the product is or is not equipped with a Wi-Fi interface. If the Wi-Fi interface is present, the Wi-Fi interface is enabled by default at delivery. If you do not want to use WLAN, you can deactivate the WLAN interface.

If the Wi-Fi interface is present, the product also has a WPS function. The WPS function is for automatically connecting the product to a network (e.g. via router) and establish a direct connection between the product and a smart end device.

## Modbus

The product is equipped with a Modbus interface. The Modbus interface is deactivated by default and must be configured as needed.

The Modbus interface of the supported SMA products is designed for industrial use – via SCADA systems, for example – and has the following tasks:

- Remote query of measured values
- Remote setting of operating parameters
- Setpoint specifications for system control
- Controlling the battery

## Grid management services

The product is equipped with service functions for grid management.

Depending on the requirements of the grid operator, you can activate and configure the functions (e.g. active power limitation) via operating parameters.

## Secure power supply operation

In case of a grid failure, the secure power supply operation supplies the loads with energy from the battery. You can connect a standard outlet (230 V) and a standard switch to the inverter. You can connect a load with a maximum of 16 A and 230/240 V to the emergency power outlet. The load is supplied with energy from the battery during grid failure. The switch is used to enable and disable secure power supply operation.

The secure power supply operation is not automatically enabled in the event of a grid failure, neither is it automatically disabled once the utility grid is available again. If the utility grid fails, the load supply must be enabled manually by activating the switch. The inverter automatically regulates the energy supply of the outlet after activating the switch. When the utility grid is available again and the load can be supplied by this again, the secure power supply operation must be disabled manually by switching the switch off.

During active secure power supply operation, the inverter is disconnected from the building's main electrical system and does not therefore feed into the utility grid. During secure power supply operation, the load can only be supplied with energy as long as there is stored energy available in the battery. If there is insufficient energy available from the battery, the secure power supply operation remains active, even if the utility grid is available again. Switching over to supplying the load from the utility grid is not carried out automatically.

### **i** Secure power supply operation in Flexible Storage Systems with backup power supply not possible

If the inverter is used in a battery-backup system and connected with an automatic transfer switch, the secure power supply operation is not available.

### **Do not connect any loads that require an uninterrupted energy supply**

The secure power supply operation and the battery-backup operation may not be used for loads that require a uninterrupted energy supply. The energy that is available during the secure power supply operation or battery-backup operation depends on the battery capacity available and the state of charge of the battery (SOC).

- Do not connect loads if they are dependent on an uninterrupted energy supply for reliable operation.

### **Battery-backup function**

The inverter is equipped with a battery-backup function. The battery-backup function is disabled by default and must be enabled via the user interface. The battery-backup function can only be enabled if the inverter is operated in a battery-backup system with an automatic transfer switching device. If the system is retrofitted with an automatic transfer switching device, the battery configuration must be reset and carried out once again. Then the battery-backup system must be configured. The configuration is carried out via the installation assistant on the user interface of the battery inverter.

The battery-backup function ensures that the inverter forms a battery-backup grid that uses energy from the battery and the PV system to supply the household grid in the event of a utility grid failure. When the battery-backup operation is activated, the automatic transfer switch disconnects the PV system and the household grid from the utility grid in the event of a grid failure, and connects these to the battery-backup grid. After a short switch-over time, the battery-backup grid and loads connected can be supplied by the battery and supplemented with energy from the PV system. The charging of the battery is ensured by the existing PV system during battery-backup operation. The charging process of the battery (initiated by the PV system) can be deactivated via a certain parameter during battery-backup operation. As soon as the utility grid is available again, the battery-backup operation is disabled automatically and the loads are supplied with energy from the utility grid. If the automatic battery-backup operation is not set, the battery-backup operation must be manually enabled in the event of a grid failure, and must also be disabled again once the utility grid is available (information in terms of switching operations of the automatic transfer switch and procedures during grid failure and grid reconnection see planning guidelines "SMA Energy System Home with Battery-Backup Function").

When the utility grid is down and the battery fully discharged, there is, in the beginning, not enough power available to create a stable battery-backup grid. In this case, the battery must be charged by the PV system. The battery inverter is able to create a stable battery-backup grid only when enough power is available in the battery. To use battery charging power from the PV system, the battery inverter has to create a stand-alone grid. For this purpose, the battery inverter requires energy from the battery reserve. If enough PV power is available, the PV inverters start automatically and the battery is charged with energy from the PV system. The battery is charged with energy until the battery inverter is able to provide a battery-backup grid. By setting parameters, it is possible to define up to which state of charge the battery is charged and discharged. If not enough PV energy is available to start the PV inverters, the stand-alone grid breaks down. The battery inverter makes



another attempt to start the PV inverter 2 hours later to charge the battery with energy from the PV system. If the battery inverter still fails to create a stand-alone grid after several attempts due to insufficient PV energy, the battery inverter and battery switch to sleep mode. In this case, a manual black start is required to switch the battery inverter and battery from sleep mode back to operation.

**i Secure power supply operation in Flexible Storage Systems with backup power supply not possible**

If the inverter is used in a battery-backup system and connected with an automatic transfer switch, the secure power supply operation is not available.

**i Do not connect any loads that require an uninterrupted energy supply**

The secure power supply operation and the battery-backup operation may not be used for loads that require an uninterrupted energy supply. The energy that is available during the secure power supply operation or battery-backup operation depends on the battery capacity available and the state of charge of the battery (SOC).

- Do not connect loads if they are dependent on an uninterrupted energy supply for reliable operation.

## Black start function

The inverter has a black start function and an auxiliary battery that provides energy for the black start. In battery-backup systems, you have the possibility to install a standard switch for black starting the inverter and battery. The black-start switch is used to start the battery-backup operation manually in the event of grid failure if the battery and inverter are in sleep mode and, therefore, are unable to provide energy. When the black-start switch is switched on manually, the energy from the auxiliary battery is made available in order to automatically switch the battery and therefore also the inverter from sleep mode to operation in order that the inverter can make energy available from the battery. You can stop the battery-backup operation by switching it off manually. To enable the black-start function, at least one battery capable of black start must be connected to input A.

## Multi-battery device

The product is equipped with the multi-battery function as standard from firmware version 1.50.10.R. The multi-battery function enables to charge and discharge several batteries of the same or different type. If the system is extended by one or several batteries or one battery is replaced, the battery configuration must be reset and carried out again. The configuration is carried out via the installation assistant on the user interface of the battery inverter. An overview of batteries approved by SMA Solar Technology AG and their possible combinations is available at [www.SMA-Solar.com](http://www.SMA-Solar.com).

## All-pole sensitive residual-current monitoring unit

The all-pole sensitive residual-current monitoring unit detects alternating and direct differential currents. In single-phase and three-phase inverters, the integrated differential current sensor detects the current difference between the neutral conductor and the line conductor(s). If the current difference increases suddenly, the inverter disconnects from the utility grid.

## SMA Smart Connected

SMA Smart Connected is the free monitoring of the product via the SMA Sunny Portal. Thanks to SMA Smart Connected, the operator and qualified person will be informed automatically and proactively about product events that occur.

SMA Smart Connected is activated during registration in Sunny Portal. In order to use SMA Smart Connected, it is necessary that the product is permanently connected to Sunny Portal and the data of the operator and qualified person is stored in Sunny Portal and up-to-date.

## Time-of-Use

The Time-of-Use (TOU) function is disabled by default and must be enabled by creating power profiles.

With the TOU function, you can adjust the charging behavior of the battery to your utility rate plan (electricity tariff). Energy bills are thus reduced and electricity at lower cost can be used. You can determine in which time range the battery with a specified charging power is operated. At specific times, this is mostly useful when the battery's state of charge has to take on a certain value or the rate plan makes the charging more attractive, regardless of the power at the grid connection point. The charging parameters set in the power profile are only limited by the state of charge (SOC). At times when the Time-of-Use function is not enabled, the battery is charged correspondent to the increased self-consumption for the entire system.

## Peak load shaving

With the "Peak Load Shaving" function, you can optimize the behavior of the battery inverter with respect to the power exchange at the point of interconnection. This is mostly useful when a higher supply of energy would lead to a higher electricity cost. With the "Peak Load Shaving" function, certain grid-exchange power outputs to which the battery inverter is adjusted depending on its power and battery capacity available can be set. Power peaks and additional costs can thus be avoided.

You can configure times and setpoints for the power drawn at the grid-connection point. When the loads require additional energy, the battery is discharged and the maximum value is kept constant at the grid-connection point. This is based on the prerequisite that the battery is sufficiently charged. At times when the "Peak Load Shaving" function is not activated, the battery is charged or discharged correspondent to the increased self-consumption for the entire system. The "Peak Load Shaving" function is deactivated by default and must be activated by creating power profiles.

## Frequency Shift Power Control

If PV inverters are connected on the AC side during battery PV-backup operation, the battery inverter must be able to limit their output power. This limitation becomes necessary when, for example, the battery inverter's battery is fully charged and the power available from the PV system exceeds the power requirement of the connected loads.

To prevent excess energy from overcharging the battery, the battery inverter automatically detects the problem and changes the frequency at the AC output. This frequency adjustment is analyzed by the PV inverter. As soon as the power frequency of the battery-backup grid increases beyond the value specified in **f Start Delta**, the PV inverter limits its output power accordingly.

The frequency shift power control is enabled by default. No additional settings must be carried out. It must be ensured that the connected PV inverters limit their power at the AC output via the battery inverter due to changes in frequency. The frequency-dependent active power limitation  $P(f)$  must be set in the PV inverter.

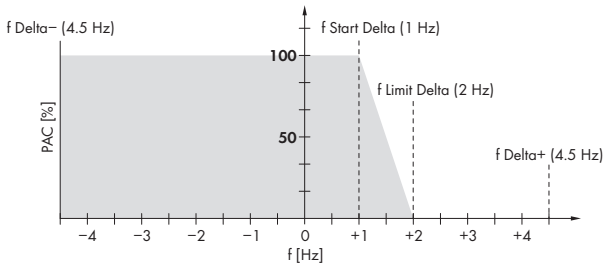

Figure 3: Impact of the frequency shift power control on the power output of a PV inverter

Designation	Explanation
<b>f</b>	Base frequency of the stand-alone grid
<b>f Delta-</b> to <b>f Delta+</b>	Maximum range in relation to the base frequency in which the PV inverter is active.
<b>f Start Delta</b>	Frequency increase in relation to the base frequency, at which point the power regulation via frequency begins.
<b>f Limit Delta</b>	Frequency increase in relation to the base frequency, at which point the power regulation via frequency ends. The power of the PV inverter at this point is 0 W.

## 4.4 LED Signals

LED signal	Explanation
The green LED is flashing (two seconds on and two seconds off)	Waiting for feed-in conditions The conditions for feed-in operation are not yet met. As soon as the conditions are met, the inverter will start feed-in operation.
The green LED is flashing (1.5 s on and 0.5 s off)	Secure power supply operation or battery-backup operation The secure power supply operation or battery-backup operation is enabled and the inverter supplies the loads with energy from the battery.
The green LED flashes quickly	Update of central processing unit The central processing unit of the inverter is being updated.
The green LED is glowing	Parallel grid operation
The green LED is off	The inverter is not feeding into the utility grid.

LED signal	Explanation
The red LED is glowing	<p>Event occurred</p> <p>If an event occurs, a distinct event message and the corresponding event number will be displayed in addition on the product user interface or in the communication product (e.g. SMA Data Manager).</p>
The blue LED flashes slowly for approx. 1 minute	<p>Communication connection is being established</p> <p>The product is establishing a connection to a local network or is establishing a direct connection to a smart device via Ethernet (e.g. smartphone, tablet or laptop).</p>
The blue LED flashes quickly for approx. two minutes (0.25 s on and 0.25 s off).	<p>WPS active</p> <p>The WPS function is active.</p>
The blue LED is glowing	<p>Communication active</p> <p>There is an active connection with a local network or there is a direct connection via Ethernet with a smart end device (e.g. smartphone, tablet or laptop).</p>

## 4.5 System Overview

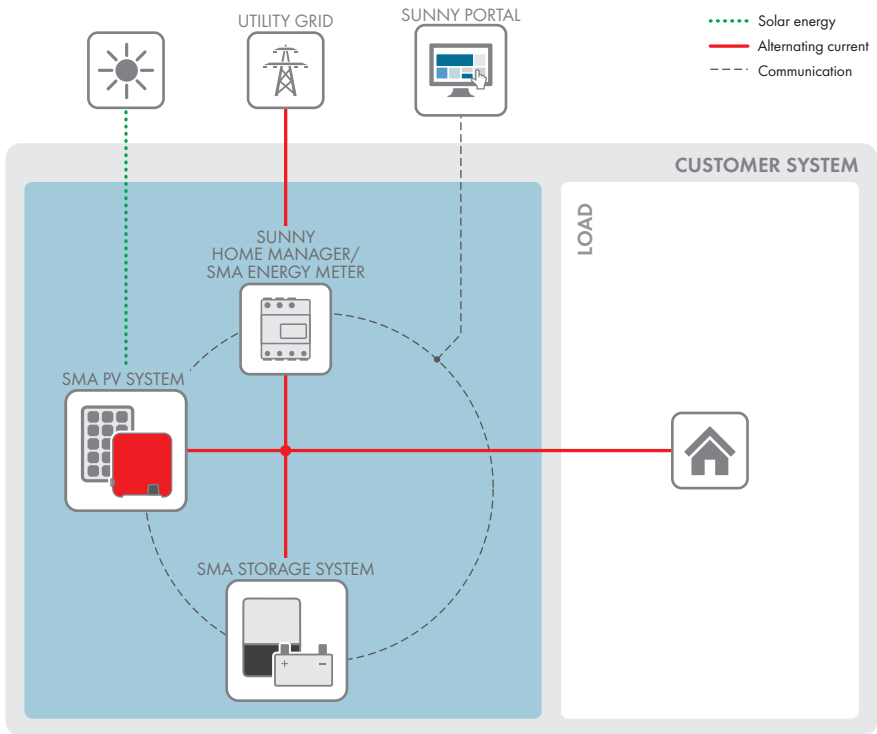

Figure 4: Design of the system

## 4.5.1 Circuitry Overview

### 4.5.1.1 System with secure power supply

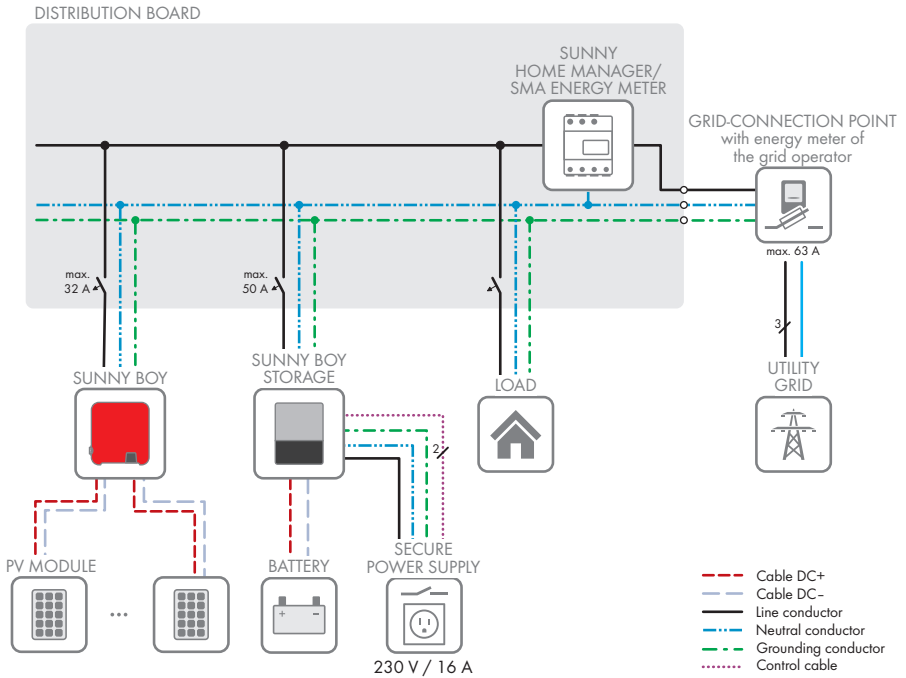

Figure 5: Circuitry overview of a Flexible Storage System with switch and outlet for secure power supply operation (example)

### 4.5.1.2 System with battery-backup function

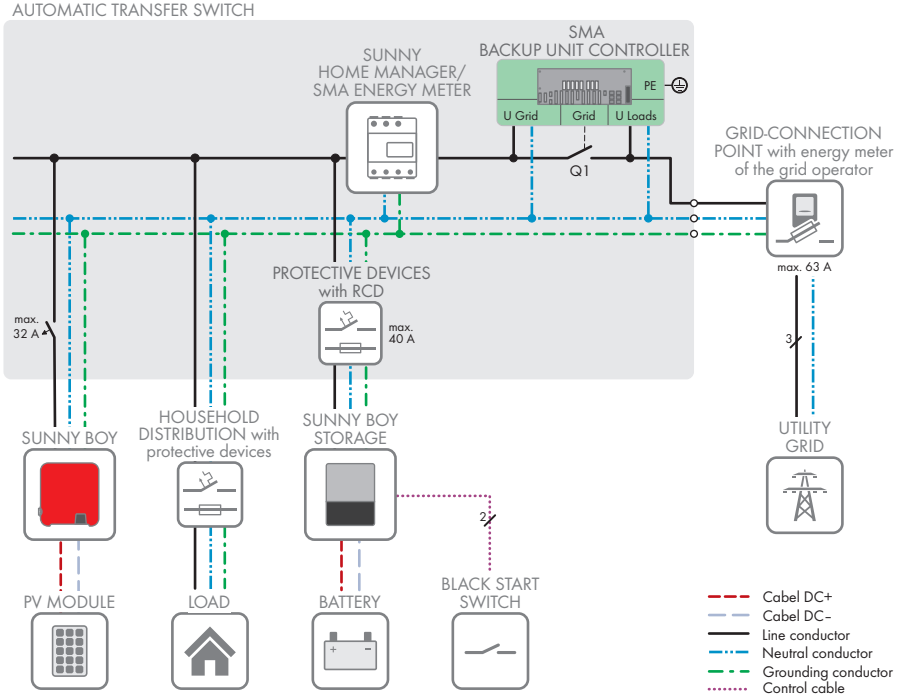

Figure 6: System design of a Flexible Storage System with battery-backup function (example)

### 4.5.2 Communication Overview

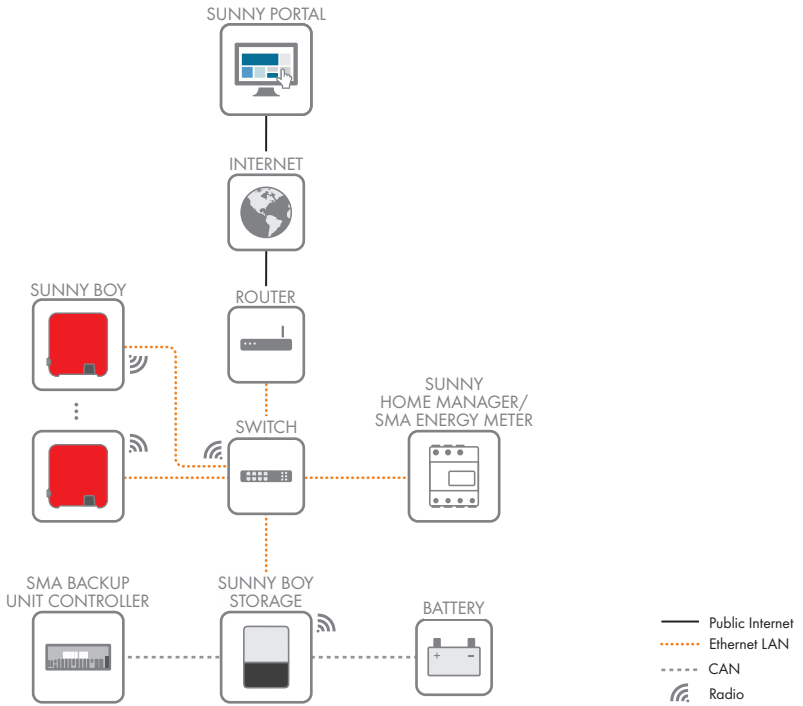

Figure 7: Design of system communication



## 4.6 "Battery Management"

### 4.6.1 Battery Use by Systems for Increased Self-Consumption

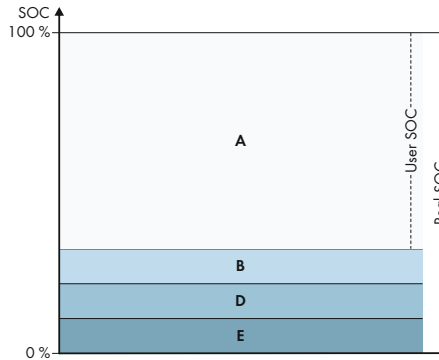

Figure 8: State of charge ranges of the battery in systems for increased self-consumption without battery backup

Range	Parameter	Battery inverter behavior
A	Self-consumption range (SlfCsmP)	The battery inverter uses the batteries within this range for increased self-consumption and for the "Time-of-Use" and "Peak Load Shaving" functions that can be configured in the power profile.
B	Range for maintaining battery state of charge (PVRes)	The battery inverter checks the current SOC every 24 hours. If the SOC is in range D, the batteries are recharged with 3 A from the utility grid until the upper limit of range B is reached. If the utility grid is not available, the batteries cannot be recharged.
D	Minimum width of deep-discharge protection range (BatRes)	The battery inverter recharges the connected batteries with 3 A. The recharging process does not stop until range A is reached.  If the utility grid is not available, the battery inverter cannot be switched on to check the SOC of the batteries.. The battery inverter and batteries are switched off. Exception: black start function
E	Lower limit of the deep-discharge protection range for disconnection (ProtRes)	When this range is reached and the utility grid is available, the battery inverter charges the batteries with 3 A from the utility grid until range A is reached.

### 4.6.2 Battery Use by Battery-Backup Systems with Increased Self-Consumption

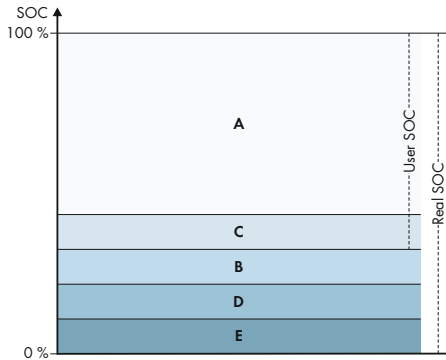

Figure 9: State of charge ranges of the battery in battery-backup systems

Range	Parameter (technical term)	Battery inverter behavior
A	Self-consumption range (SlfCsmP)	The battery inverter uses the batteries within this range for increased self-consumption and for the "Time-of-Use" and "Peak Load Shaving" functions that can be configured in the power profile.
C	Minimum width of backup power range (BURes)	<p>Range for battery-backup operation during grid failure This range is set to 0% by default. If an automatic transfer switching device is connected, the range must be set depending on your needs. The setting value refers to the user SOC.</p> <p>Utility grid available:</p> <p>When the upper limit of C is reached, the battery inverter goes into standby mode. The batteries remain switched on. Excess PV energy is used for conserving the battery charge.</p> <p>When the SOC in range C has decreased by the set value of range B, the battery inverter recharges the batteries with 3 A from the utility grid.</p> <p>If the set value of the parameter for range B is higher than the set value of the parameter for range C, the batteries are recharged in range D first.</p>

Range	Parameter (technical term)	Battery inverter behavior
B	Range for maintaining battery state of charge (PVRes)	<p>Utility grid available:</p> <p>The battery inverter checks the current SOC every 24 hours. If the SOC is in range D, the batteries are recharged with 3 A from the utility grid until the upper limit of range C is reached.</p> <p>During battery-backup operation:</p> <p>The battery inverter starts up every 2 hours for approx. 6 minutes and attempts to charge the batteries with PV energy. If no excess PV energy is available, the battery inverter switches to standby mode.</p>
D	Minimum width of deep-discharge protection range (BatRes)	<p>Once the limit from B to D is reached, the battery and battery inverter switch off. The battery-backup operation can be enabled by switching on the black-start switch of the battery inverter. If the battery is not recharged after 6 minutes, the battery-backup operation will be stopped. No automatic start-up process will be initiated after 2 hours</p> <p>When range D is reached and the utility grid is available, the battery inverter charges the batteries with 3 A from the utility grid.</p>
E	Lower limit of the deep-discharge protection range for disconnection (ProfRes)	<p>If range E is reached during battery-backup operation, the batteries are switched off. The battery inverter is also switched off due to a lack of DC voltage.</p> <p>When range E is reached and the utility grid is available, the battery inverter charges the batteries with 3 A from the utility grid until range A is reached.</p>

## 5 Mounting

### 5.1 Requirements for Mounting

Requirements for the mounting location:

#### **⚠ WARNING**

##### **Danger to life due to fire or explosion**

Despite careful construction, electrical devices can cause fires. This can result in death or serious injury.

- Do not mount the product in areas containing highly flammable materials or gases.
  - Do not mount the product in potentially explosive atmospheres.
- A solid support surface must be available (e.g., concrete or masonry). When mounted on drywall or similar materials, the product emits audible vibrations during operation which could be perceived as annoying.
  - The mounting location must be inaccessible to children.
  - The mounting location must be suitable for the weight and dimensions of the product (see Section 14, page 141).
  - The mounting location must not be exposed to direct solar irradiation. If the product is exposed to direct solar irradiation, the exterior plastic parts might age prematurely and overheating might occur. When becoming too hot, the product reduces its power output to avoid overheating.
  - The mounting location should be freely and safely accessible at all times without the need for any auxiliary equipment (such as scaffolding or lifting platforms). Non-fulfillment of these criteria may restrict servicing.
  - All ambient conditions must be met (see Section 14, page 141).
  - To ensure optimum operation, the ambient temperature should be between  $-25^{\circ}\text{C}$  and  $+45^{\circ}\text{C}$ .

**Permitted and prohibited mounting positions:**

- The product may only be mounted in a permitted position. This will ensure that no moisture can penetrate the product.
- The product should be mounted such that the LED signals can be read off without difficulty.

$90^{\circ} \dots 75^{\circ}$

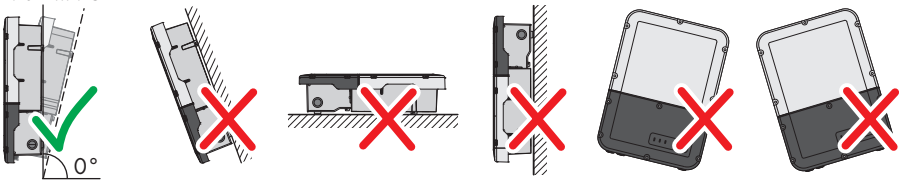

Figure 10: Permitted and prohibited mounting positions

Do not mount multiple inverters directly above one another.

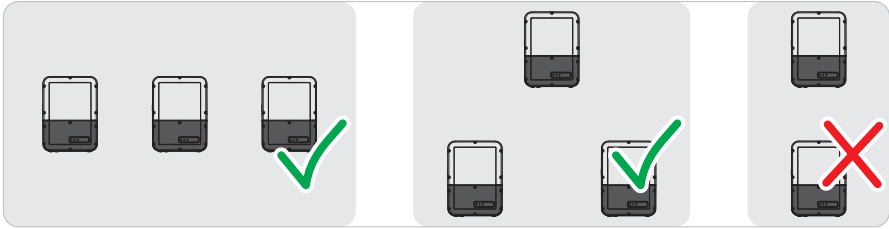

Figure 11: Permissible and impermissible mounting positions of multiple inverters

**Dimensions for mounting:**

Figure 12: Position of the anchoring points(Dimensions in mm)

**Recommended clearances:**

If you maintain the recommended clearances, adequate heat dissipation will be ensured. Thus, you will prevent power reduction due to excessive temperature.

- Maintain the recommended clearances to walls as well as to other inverters or objects.
- If multiple products are mounted in areas with high ambient temperatures, increase the clearances between the products and ensure sufficient fresh-air supply.

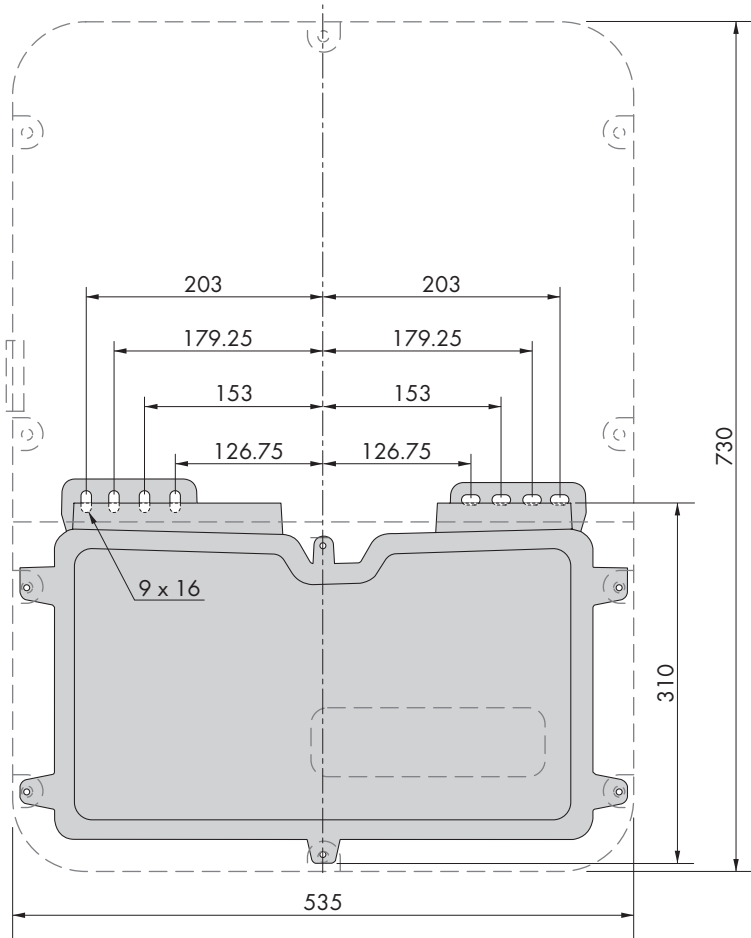
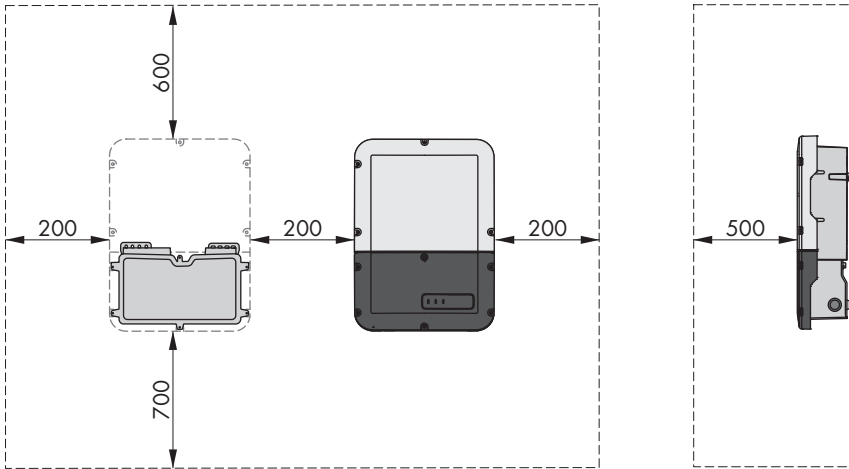

Figure 13: Recommended clearances (Dimensions in mm)

## 5.2 Mounting the product

**Additionally required mounting material (not included in the scope of delivery):**

- 2 screws suitable for the support surface (diameter: 8 mm)
- 2 washers suitable for the screws
- Where necessary, 2 screw anchors suitable for the support surface and the screws

### **CAUTION**

#### **Risk of injury due to weight of product**

Injuries may result if the product is lifted incorrectly or dropped while being transported or mounted.

- Transport and lift the product carefully. Take the weight of the product into account.
- Wear suitable personal protective equipment for all work on the product.

#### **Procedure:**

1. Opening the Connection Unit Unscrew all 6 screws (TX25) and carefully remove the enclosure lid toward the front.

2. Unscrew the 2 screws on the right and left side of the Power Unit (TX25). As a result, the Power Unit and the Connection Unit are not connected to one another.

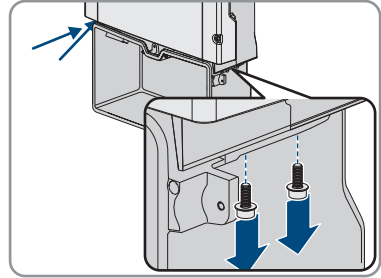

3. Disconnect the Connection Unit from the Power Unit.
4. Align the connection unit horizontally and vertically. Mark the position of the drill holes using the brackets.

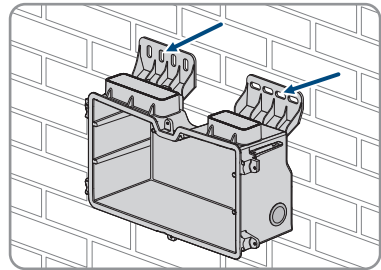

5. Drill the holes in the marked positions.
6. Insert screw anchors into the drill holes if the support surface requires them.
7. Secure the Connection Unit horizontally using screws and washers.

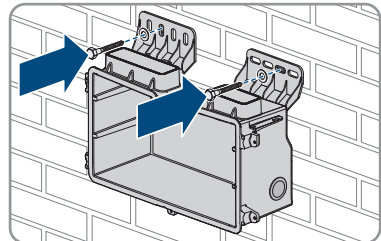

8. Check whether the Connection Unit is firmly positioned.



9. Plug the Power Unit into the Connection Unit. Make sure that the screw holes on the left and right sides of the Power Unit are directly over those of the Connection Unit; and the cables protruding from the Power Unit must not be pinched.

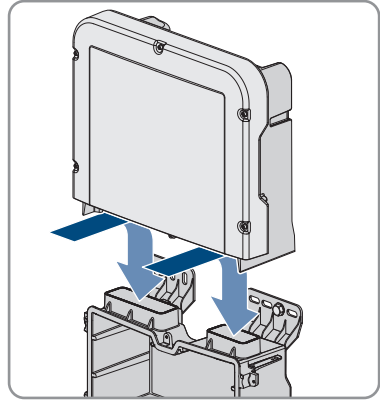

10. Tighten 2 screws on the right and left side of the Power Unit (TX25) (torque:  $6 \text{ Nm} \pm 0.3 \text{ Nm}$ ).

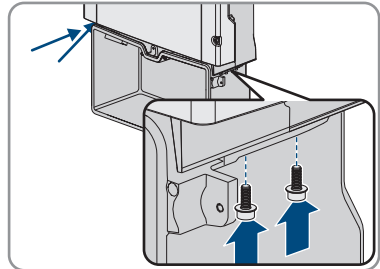

11. Remove the adhesive tape with which the ribbon cable is attached to the Connection Unit.

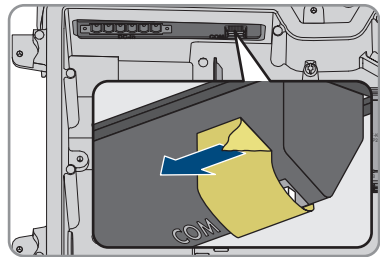

12. Pull the ribbon cable used to connect the communication assembly to the Power Unit into the Connection Unit, and plug it into the jack on the communication assembly.

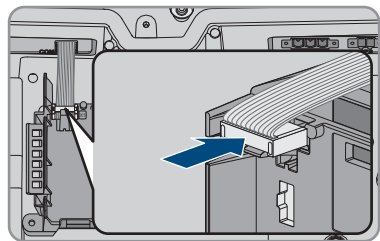

13. Insert the ribbon cable used to connect the communication assembly to the battery interface module into the jack on the battery interface module and lock it.

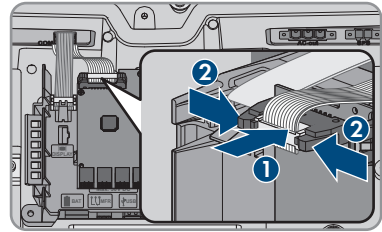

14. Insert the DC terminal block into the **DC-in** slot. Tighten the screws using a flat-blade screwdriver (blade width: 3.5 mm (0.14 in)) (torque: 0.3 Nm (2.65 in-lb)).

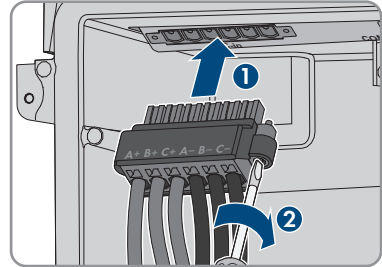

## 6 Electrical Connection

### 6.1 Overview of the Connection Area

#### 6.1.1 View from Below

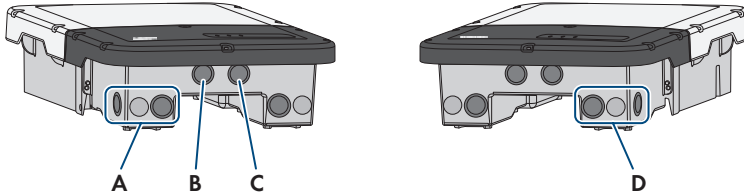

Figure 14: Enclosure openings at the bottom of the inverter

Position	Designation
A	Enclosure opening for the DC connection
B	Enclosure opening for the battery communication cable of the Antenna Extension Kit (optional)
C	Enclosure opening for the network cables and, if needed, for other data cables
D	Enclosure opening for the AC connection and the connection cables of the outlet and of the switch for the secure power supply operation or for the signal cable for the black start

## 6.1.2 Interior View

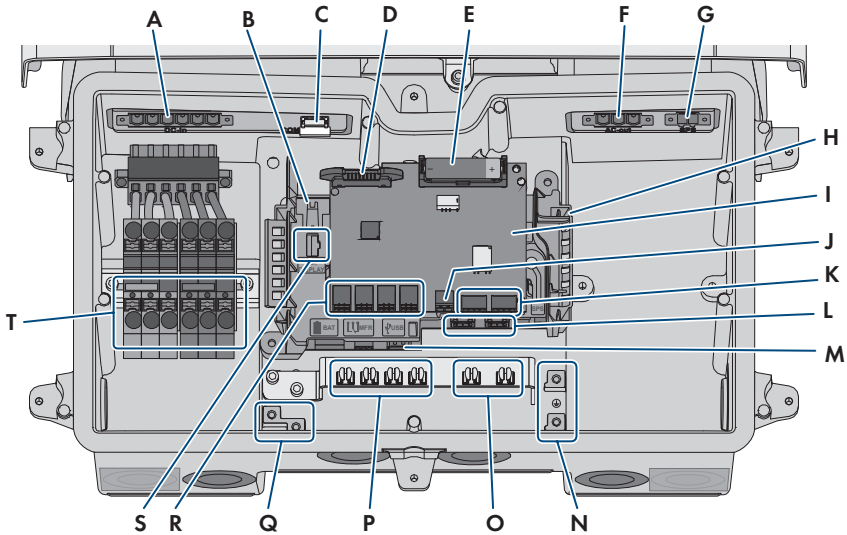

Figure 15: Connection areas in the interior of the inverter

Position	Designation
A	<b>DC-in</b> slot for DC connection
B	Jack for connecting the ribbon cable for the connection of the communication assembly to the Power Unit.
C	<b>COM</b> slot with inserted ribbon cables to connect communication assembly and battery interface module with Power Unit
D	Slot for slim ribbon cable to connect Power Unit with battery interface module
E	Auxiliary battery (3.6 V, 2600 mAh, size: AA / 14500) After switching the black-start switch, energy is made available from the auxiliary battery in order to switch the battery and therefore also the inverter on when they are in sleep mode. The auxiliary battery is designed to function for the entire service life of the product and must not be replaced when used in the usual manner.
F	Slot <b>AC-out</b> for direct connection to utility grid or automatic transfer switch
G	<b>SPS</b> slot for connecting the secure power supply outlet
H	Communication assembly
I	Battery Interface Module
J	Jack to connect switch for secure power supply operation or switch for black start function

Position	Designation
K	No function
L	Network ports <b>A</b> and <b>B</b> for connecting a router or network switch and for connecting an SMA Energy Meter
M	<b>USB</b> port for connecting a USB flash drive (for service purposes)
N	Grounding point for the grounding conductor of the utility grid, the outlet for secure power supply operation and, if necessary, an additional grounding or for the equipotential bonding
O	Shield clamps for the connection of the cable shields of the RS485 communication cables
P	Shield clamps for the connection of the cable shields of the battery communication cables
Q	Grounding point for grounding the battery/batteries
R	Jacks <b>BAT1</b> to <b>BAT4</b> for the connection of the battery communication cable and the communication cable of the automatic transfer switch
S	Jack <b>DISPLAY</b> for the LED assembly connection in the enclosure lid of the Connection Unit
T	Terminal blocks for DC connection

## 6.2 Grounding

### 6.2.1 Overview of Grounding Connection

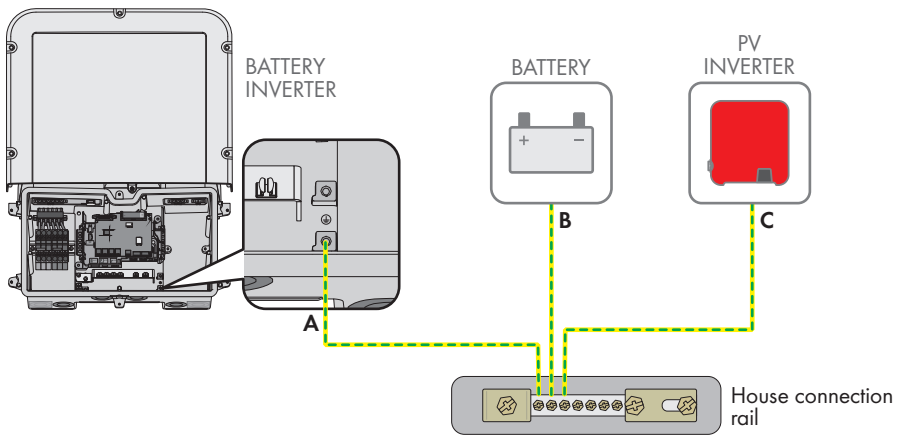

### 6.2.2 Requirements for Battery Inverter Grounding Cable

- Conductor type: copper wire

- External diameter: 18 mm
- Conductor cross-section: 4 mm<sup>2</sup> to 16 mm<sup>2</sup>
- Sheath stripping length: 250 mm
- The cable must be dimensioned in accordance with the local and national directives for the dimensioning of cables. The requirements for the minimum wire size derive from these directives. Examples of factors influencing cable dimensioning are: nominal AC current, type of cable, routing method, cable bundling, ambient temperature and maximum desired line losses (for calculation of line losses, see the design software "Sunny Design" from software version 2.0 at [www.SMA-Solar.com](http://www.SMA-Solar.com)).

## 6.3 AC Connection

### 6.3.1 Requirements for the AC Connection

#### AC cable requirements as follows:

- Conductor type: copper wire
- External diameter: 18 mm
- Conductor cross-section: 4 mm<sup>2</sup> to 16 mm<sup>2</sup>
- Insulation stripping length: 18 mm
- Sheath stripping length: 250 mm
- The cable must be dimensioned in accordance with the local and national directives for the dimensioning of cables. The requirements for the minimum wire size derive from these directives. Examples of factors influencing cable dimensioning are: nominal AC current, type of cable, routing method, cable bundling, ambient temperature and maximum desired line losses (for calculation of line losses, see the design software "Sunny Design" from software version 2.0 at [www.SMA-Solar.com](http://www.SMA-Solar.com)).

#### Load-break switch and cable protection:

#### NOTICE

#### **Damage to the inverter due to the use of screw-type fuses as load-break switches**

Screw-type fuses (e.g. DIAZED fuse or NEOZED fuse) are not load-break switches.

- Do not use screw-type fuses as load-break switches.
  - Use a load-break switch or circuit breaker as a load disconnection unit (for information and design examples, see the Technical Information "Circuit Breaker" at [www.SMA-Solar.com](http://www.SMA-Solar.com)).
- In PV systems with multiple inverters, protect each inverter with a separate circuit breaker. Make sure to observe the maximum permissible fuse protection (see Section 14, page 141). This will prevent residual voltage from being present at the corresponding cable after disconnection.
  - Loads installed between the inverter and the circuit breaker must be fused separately.

**Residual-current monitoring unit:**

The inverter does not require an external residual-current device when operating. If local regulations require the use of a residual-current device, the following must be observed:

- The inverter is compatible with type A and B residual-current devices that have a rated residual current of 100 mA or higher (information about the selection of a residual-current device see technical information "Criteria for Selecting a Residual-Current Device" at [www.SMA-Solar.com](http://www.SMA-Solar.com)). Each inverter in the system must be connected to the utility grid via a separate residual-current device.

**Overvoltage category:**

The product can be used in grids of overvoltage category III or lower in accordance with IEC 60664-1. That means that the product can be permanently connected to the grid-connection point of a building. In case of installations with long outdoor cabling routes, additional measures to reduce overvoltage category IV to overvoltage category III are required (see the Technical Information "Overvoltage Protection" at [www.SMA-Solar.com](http://www.SMA-Solar.com)).

**Grounding conductor monitoring:**

The inverter is equipped with a grounding conductor monitoring device. This grounding conductor monitoring device detects when there is no grounding conductor connected and disconnects the inverter from the utility grid if this is the case. Depending on the installation site and grid configuration, it may be advisable to disable the grounding conductor monitoring. This can be necessary, for example, in a Delta IT system or other grid configurations if there is no neutral conductor present and you intend to install the inverter between two line conductors. If you are uncertain about this, contact your grid operator or SMA Solar Technology AG.

- Grounding conductor monitoring must be disabled after initial start-up depending on the grid configuration (see Section 8.18, page 91).

## 6.3.2 Connecting the Inverter to the Utility Grid

### QUALIFIED PERSON

**Requirements:**

- The connection requirements of the grid operator must be met.
- The grid voltage must be within the permissible range. The exact operating range of the inverter is specified in the operating parameters.

**Procedure:**

1. Disconnect the AC miniature circuit breaker and secure against reconnection.
2. Remove the adhesive tape from the enclosure opening for the AC connection.
3. Insert the cable gland into the opening and tighten it with the counter nut from the inside.
4. Guide each cable into the inverter. In the process, lay each cable in such a way that they do not come into contact with the communication assembly.
5. Connect the grounding conductor to the grounding terminal:

- Strip off the conductor insulation by 18 mm.

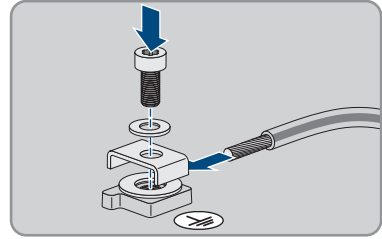

- Insert the screw through the conical spring washer, the clamping bracket and the washer.
  - Guide the conductor between the washer and clamping bracket and tighten the screw (TX 25) (torque:  $6 \text{ Nm} \pm 0.3 \text{ Nm}$ ).
6. Plug the terminal block for the AC connection in the **AC-out** slot in the inverter, and tighten it with a flat-blade screwdriver (blade width: 3.5 mm) (torque: 0.3 Nm).

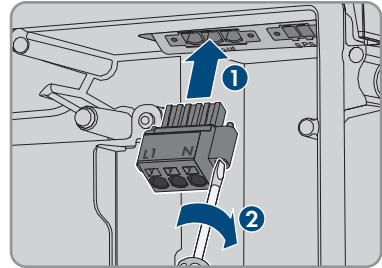

7. Ensure that the terminal block is securely in place and the screws are tightened.
8. Thread the conductors L and N through the ferrite.
9. Strip off the conductor insulation of L1 and N 18 mm.
10. In the case of fine stranded wire, provide the conductors with a bootlace ferrule.

11. **i** **Connection of conductors of finely stranded wire**

To connect conductors made of finely stranded wire, each terminal point must be opened.

- First insert the conductor into the terminal point all the way to the lock (round opening). Then insert a flat-blade screwdriver (blade width: 3.5 mm) as far as it can go into the actuation shaft (rectangular opening). Hereby the lock opens and the conductor can be placed into the terminal point as far as possible. After the connection has been made, the flat-blade screwdriver must be pulled out of the actuation shaft.

12.

**⚠ WARNING**

**Fire hazard due to faulty conductor connection**

If the conductors are inserted into the actuation shafts (right-angled openings), a fire may occur during inverter commissioning.

13. Connect the conductors to the terminal block for the AC connection:



- Connect the neutral conductor to the terminal block in accordance with the labeling. Insert the conductor into the corresponding terminal point (round opening) up to the stop.

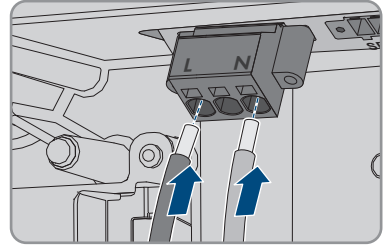

- Connect L to the terminal block in accordance with the labeling. Insert the conductor into the corresponding terminal point (round opening) up to the stop.

14. Ensure the conductors are plugged into the terminal points (round openings) as far as it will go and not into the actuation shafts (rectangular openings).

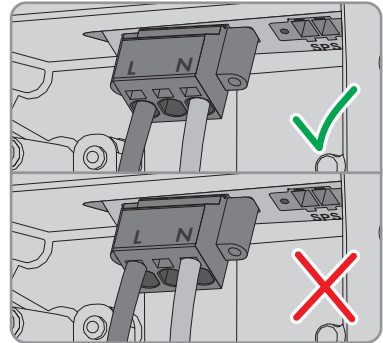

15. Ensure that the terminal points are allocated to the correct conductors.
16. Ensure that the conductors are plugged completely into the terminal points up to their insulation.
17. Position the ferrite as close as possible to the bottom of the AC connection terminal block and secure using the cable tie.

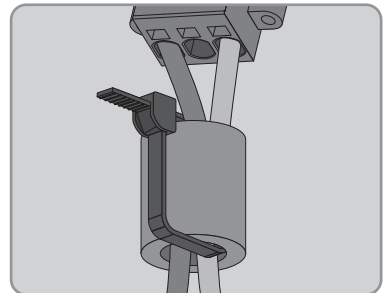

### 6.3.3 Connecting Additional Grounding

#### **⚠ QUALIFIED PERSON**

If additional grounding or equipotential bonding is required locally, you can connect additional grounding to the product. This prevents touch current if the grounding conductor at the terminal for the AC cable fails.

### **i** Grounding of the battery

The grounding of the battery must not be connected to the connection point for additional grounding on the inverter.

- Connect the grounding of the battery to the grounding point of the battery.
- Ground the battery according to the battery manufacturer's specifications.

#### **Cable requirements:**

### **i** Use of fine-stranded conductors

You can use an inflexible or a flexible, fine-stranded conductor.

- When using a fine-stranded conductor, it has to be double crimped by a ring terminal lug. Make sure that no insulated conductor is visible when pulling or bending. This will ensure sufficient strain relief by means of the ring terminal lug.

Grounding cable cross-section: max. 10 mm<sup>2</sup>

#### **Procedure:**

- Connect the grounding conductor to the grounding terminal:
  - Strip off the conductor insulation by 18 mm.

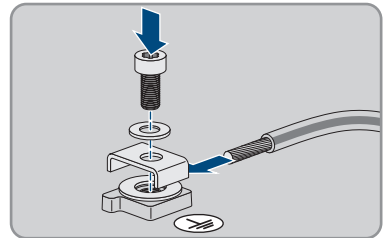

- Insert the screw through the conical spring washer, the clamping bracket and the washer.
- Guide the conductor between the washer and clamping bracket and tighten the screw (TX 25) (torque: 6 Nm ± 0.3 Nm).

## 6.4 Connecting the Network Cables

### QUALIFIED PERSON

### DANGER

#### **Danger to life due to electric shock in case of overvoltages and if surge protection is missing**

Overvoltages (e. g. in the event of a flash of lightning) can be further conducted into the building and to other connected devices in the same network via the network cables or other data cables if there is no surge protection. Touching live parts and cables results in death or lethal injuries due to electric shock.

- Ensure that all devices in the same network and the battery are integrated into the existing surge protection.
- When laying the network cables or other data cables outdoors, it must be ensured that a suitable surge protection device is provided at the transition point of the cable from the product or the battery outdoors to the inside of a building.
- The Ethernet interface of the product is classified as "TNV-1" and offers protection against overvoltages of up to 1.5 kV.

#### **Additionally required material (not included in the scope of delivery):**

- 1 to 2 network cables
- Where required: Field-assembly RJ45 connector.

#### **Network cable requirements:**

The cable length and quality affect the quality of the signal. Observe the following cable requirements:

- Cable type: 100BaseTx
- Cable category: minimum CAT5e
- Plug type: RJ45 of Cat5, Cat5e or higher
- Shielding: SF/UTP, S/UTP, SF/FTP or S/FTP
- Number of insulated conductor pairs and insulated conductor cross-section: at least 2 x 2 x 0.22 mm<sup>2</sup>
- Maximum cable length between 2 nodes when using patch cables: 50 m
- Maximum cable length between 2 nodes when using installation cables: 100 m
- UV-resistant for outdoor use.

#### **Procedure:**

1.

### DANGER

#### **Danger to life due to electric shock**

- Disconnect the inverter from all voltage sources (see Section 9, page 96).

2. Remove the sealing plugs from the network connection opening on the inverter.

3. Insert the cable gland into the opening and tighten it with the counter nut from the inside.
4. Cut into the two-hole cable support sleeve with a box cutter. This will push the cable into the grommet.
5. Press the cable support sleeve into the two-hole cable gland.
6. Insert the cable into the enclosure opening of the two-hole cable support sleeve.
7. Lead one end of each network cable into the inverter.
8. Put the network plug of each cable into one of the network sockets of the communication assembly.

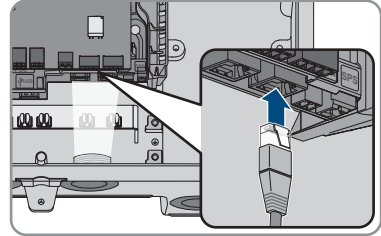

9. Ensure that the network connector is securely in place by pulling slightly on each cable.
10. Connect the other end of the network cable to the energy meter.

## 6.5 Connecting the energy meter

### **⚠ QUALIFIED PERSON**

This section describes how to connect the energy meter to the inverter.

The energy meter measures the flow of energy out of and into the utility grid. The measured values of the energy meter are transmitted to the inverter and influence the charging behavior of the battery. The energy meter data may not be used for billing purposes.

#### **Additionally required material (not included in the scope of delivery):**

- 1 approved energy meter (SMA Energy Meter or Sunny Home Manager)
- 1 network cable

#### **Network cable requirements:**

The cable length and quality affect the quality of the signal. Observe the following cable requirements:

- Cable type: 100BaseTx
- Cable category: minimum CAT5e
- Plug type: RJ45 of Cat5, Cat5e or higher
- Shielding: SF/UTP, S/UTP, SF/FTP or S/FTP
- Number of insulated conductor pairs and insulated conductor cross-section: at least 2 x 2 x 0.22 mm<sup>2</sup>
- Maximum cable length between 2 nodes when using patch cables: 50 m
- Maximum cable length between 2 nodes when using installation cables: 100 m
- UV-resistant for outdoor use.

**Procedure:**

1. Disconnect the product from voltage sources (see Section 9, page 96).
2. Remove the sealing plugs from the network connection opening on the inverter.
3. Insert the cable gland into the opening and tighten it with the counter nut from the inside.
4. Cut into the two-hole cable support sleeve with a box cutter. This will push the cable into the grommet.
5. Press the cable support sleeve into the two-hole cable gland.
6. Insert the cable into the enclosure opening of the two-hole cable support sleeve.
7. Lead one end of each network cable into the inverter.
8. When using a self-assembly network cable, assemble the RJ45 connectors and connect them to the network cable (see connector documentation).
9. Put the network plug of each cable into one of the network sockets of the communication assembly.

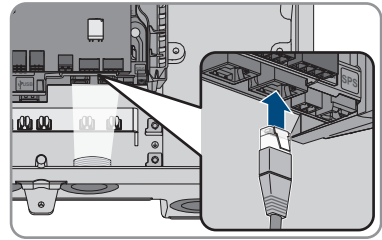

10. Ensure that the network connector is securely in place by pulling slightly on each cable.
11. If the inverter is installed outdoors, install surge protection device.
12. If you would like to establish a direct connection, connect the other end of the network cable directly to the end device.
13. If you would like to integrate the inverter into a local network, connect the other end of the network cable to the local network (e.g. via a router).

## 6.6 Connecting CAN communication cable

### **⚠ QUALIFIED PERSON**

Connect the communication cable of each battery and, in battery-backup systems, the communication cable of the automatic transfer switch as described in the following.

#### **i** Communication between inverter and battery

- Communication between the inverter and the battery takes place via the battery communication cable via CAN bus.

#### **Additionally required material (not included in the scope of delivery):**

- 1 battery communication cable for the communication between inverter and battery
- In battery-backup systems with automatic transfer switch: one communication cable between inverter and automatic transfer switch

#### **Network cable (SBS to switch, battery to switch) requirements:**

- Twisted pair conductors

- Cable category: minimum CAT5e
- Cable with shielding: Yes
- Conductor cross-section: 0.25 mm<sup>2</sup> to 0.34 mm<sup>2</sup>
- Recommended number of conductor pairs: 4
- External diameter: 6 mm to 8.5 mm
- Maximum cable length between battery and inverter and, in battery-backup systems, between automatic transfer switch and inverter: 10 m
- The cable has to be insulated for 600 V.
- UV-resistant for outdoor use.
- Comply with the requirements of the battery manufacturer.

**Assignment of the terminal block:**

Terminal block	Position	Assignment
	A	Not assigned
	B	Enable
	C	GND
	D	CAN L
	E	CAN H
	F	+12 V supply for automatic transfer switching device

**Procedure:**

1. Remove the sealing plugs from the network connection opening on the inverter.
2. Insert the cable gland into the opening and tighten it with the counter nut from the inside.
3. Lead the communication cable into the inverter.
4. Strip the communication cable 50 mm.
5. Trim the cable shield to a length of 15 mm and fold it over the cable sheath.

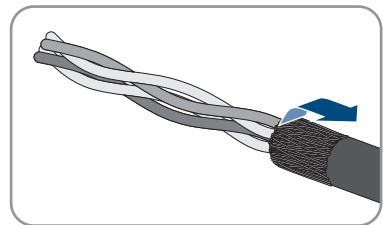

6. Strip the insulation on the insulated conductors each by 6 mm. The **CAN L** and **CAN H** must be a twisted pair.
7. If necessary, trim unused insulated conductors flush with the cable sheath or fold it over the cable sheath.

8. Connect the conductors of the communication cables to a 6-pole terminal block. Pay attention to the assignment of the terminal block and communication connection on the battery and/or automatic transfer switch and make sure that **CAN L** and **CAN H** consist of a pair of conductors.

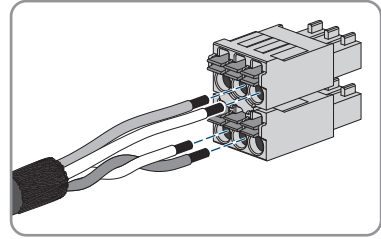

9. Ensure that the conductors are plugged into the terminal points tightly by pulling slightly on the conductors.

10. Insert the terminal block for the communication connection into the jack **BATx** on the battery interface module. If only one battery is available, insert the plug into the jack **BAT1**. If multiple batteries and/or an automatic transfer switch are available, insert the communication connection of the first battery into the jack **BAT1** and connect all other communication cables in succession to the respective jacks.

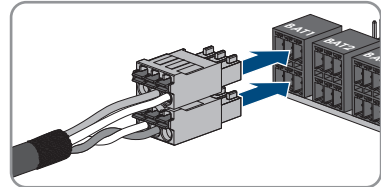

11. Press the communication cable with cable shield into the shield clamp on the busbar below the communication assembly.

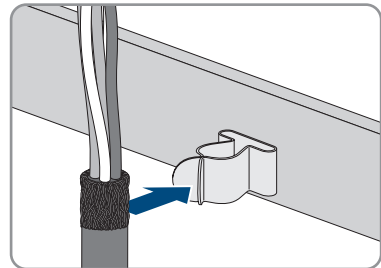

## 6.7 Connecting the switch and outlet for secure power supply operation

### ⚠ QUALIFIED PERSON

#### **i** Neutral and grounding conductor of output for secure power supply permanently connected

The inverter's output for secure power supply includes a permanent connection between neutral and grounding conductor, which cannot be disconnected.

**i** **Do not connect loads that require a stable electricity supply to the outlet for secure power supply operation.**

Secure power supply operation must not be used for loads that require a stable electricity supply. The power available during secure power supply operation depends on the solar irradiation on the PV system. Therefore, power output can fluctuate considerably depending on the weather or may not be available at all.

- Do not connect loads to the outlet for secure power supply operation if they are dependent on a stable electricity supply for reliable operation.

**Requirements:**

- The technical requirements for connecting the switch and outlet for secure power supply operation must be met (see Section 14, page 141).

**Residual-current device:**

- SMA Solar Technology AG recommends installing a residual-current device (type A) between the inverter's output for secure power supply and the outlet for secure power supply operation, which trips at a residual current of 30 mA. Observe all locally applicable standards and directives when doing so.

**Additionally required material (not included in the scope of delivery):**

- 1 standard outlet
- 1 standard switch (e.g. light switch)

**Procedure:**

- Connect the outlet for secure power supply operation
- Connecting the switch for secure power supply operation

**Connect the outlet for secure power supply operation**

**Requirements for the conductors:**

- Conductor type: copper wire
- The conductors must be made of solid wire, stranded wire or fine stranded wire. When using fine stranded wire, bootlace ferrules must be used.
- Conductor cross-section: 2.5 mm<sup>2</sup> to 4 mm<sup>2</sup>
- Maximum length of conductors: 10 m

**Procedure:**

1. Ensure that the inverter is disconnected from all voltage sources (see Section 9, page 96).
2. Remove the sealing plug from the enclosure opening for connecting the outlet for secure power supply operation.
3. Insert the cable gland into the opening and tighten it with the counter nut from the inside.
4. Guide the conductors into the inverter.
5. Connect the outlet's grounding conductor to a grounding point for secure power supply operation:



- Strip off the conductor insulation by 18 mm.
- Insert the screw through the conical spring washer, the clamping bracket and the washer.

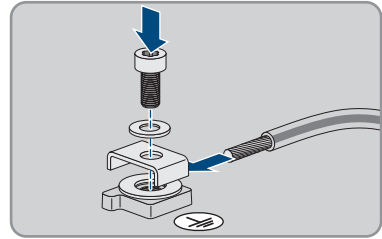

- Guide the conductor between the washer and clamping bracket and tighten the screw (TX 25) (torque:  $6 \text{ Nm} \pm 0.3 \text{ Nm}$ ).

6. Plug the terminal block for connecting the outlet for secure power supply operation into the **SPS** slot in the inverter and tighten it with a flat-blade screwdriver (blade width: 3.5 mm (0.14 in)).

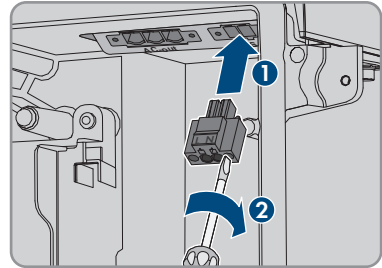

7. Ensure that the terminal block is securely in place.
8. Strip off the conductor insulation by max. 15 mm.
9. In the case of finely stranded wire, provide the conductors L and N with a bootlace ferrule.

#### 10. **i** Connection of conductors of finely stranded wire

To connect conductors made of finely stranded wire, each terminal point must be opened.

- First insert the conductor into the terminal point all the way to the lock (round opening). Then insert a flat-blade screwdriver (blade: 3.5 mm) as far as it can go into the actuation shaft (rectangular opening). Hereby the lock opens and the conductor can be placed into the terminal point as far as possible. After the connection has been made, the flat-blade screwdriver must be pulled out of the actuation shaft.

11.

### **⚠ WARNING**

#### **Fire hazard due to faulty conductor connection**

If the conductors are inserted into the actuation shafts (right-angled openings), a fire may occur during inverter commissioning.

12. Connect the conductors L and N to the terminal block in accordance with the labeling. Insert each conductor into the corresponding terminal point (round opening) up to the stop.

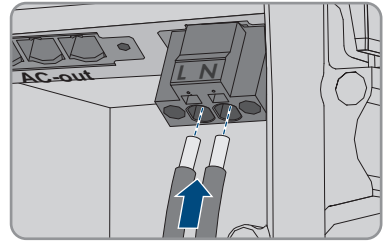

13. Ensure the conductors are plugged into the terminal points (round openings) as far as is will go and not into the actuation shafts (rectangular openings).

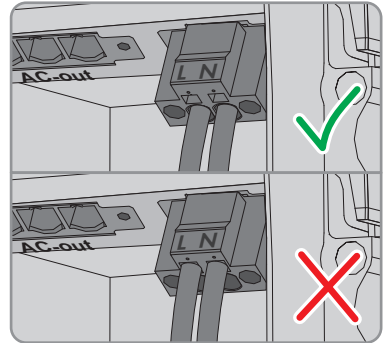

14. Ensure that the terminal points are allocated to the correct conductors.  
 15. Ensure that the conductors are plugged completely into the terminal points up to their insulation.  
 16. Install outlet in desired position (e.g. next to the inverter or as switch/outlet combination optionally at short distance from the inverter (to max. 10 m)).  
 17. Connect the other end of the cable using it directly as energy supply to the outlet.

### Connect the switch for secure power supply operation

**i** The switch for secure power supply operation must be connected to the Rooftop Communication Kit module (not the inverter) when using TS4-O module technology components.

When using TS4-O, secure power supply operation is only available if an external rapid shutdown initiator and the switch for secure power supply operation are connected to the Rooftop Communication Kit module. The switch for secure power supply operation must be connected to the module in series with a voltage supply of 18 V (e.g. two 9 V batteries). If an external rapid-shutdown initiator is used, the AC miniature circuit breaker is no longer the rapid-shutdown initiator in the system.

### Connection overview

#### Requirements for the conductors:

- Conductor cross-section: 0.2 mm<sup>2</sup> to 2.5 mm<sup>2</sup>
- The conductor type and wiring method must be appropriate for the application and location.
- Maximum length of conductors: 10 m

**Procedure:**

1. Ensure that the inverter is disconnected from all voltage sources (see Section 9, page 96).
2. Remove the sealing plug from the opening for connecting the switch for secure power supply operation.
3. Insert the cable gland into the opening and tighten it with the counter nut from the inside.
4. Guide the conductors into the inverter.
5. Strip off the conductor insulation by min. 6 mm to max. 10 mm.
6. Connect the conductors to the 2-pole terminal blocks. Ensure that the conductors are plugged completely into the terminal points up to their insulation.

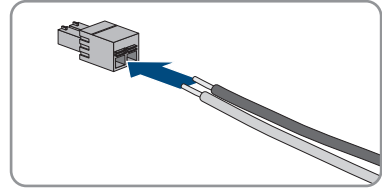

7. Stick the terminal block into the slot  on the battery interface module in the inverter.

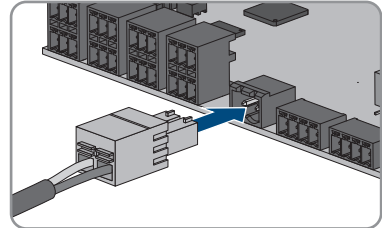

8. Ensure that the terminal block is securely in place.
9. Ensure that all conductors are correctly connected.
10. Ensure that the conductors sit securely in the terminal points. Tip: To release the conductors from the terminal block, open the terminal points using a suitable tool.
11. Install switch in desired position (e.g. next to the inverter or as switch/outlet combination optionally at short distance from the inverter (to max. 10 m)).
12. Connect the other end of the cable directly to the switch.

## 6.8 Connecting Switch for black start (in battery-backup systems)

### QUALIFIED PERSON

The switch for black start is connected to the same jack as the switch for secure power supply operation. Observe that the secure power supply operation is not available in battery-backup systems.

#### Requirements for the conductors:

- Conductor cross-section: 0.2 mm<sup>2</sup> to 2.5 mm<sup>2</sup>
- The conductor type and wiring method must be appropriate for the application and location.
- Maximum length of conductors: 10 m

**Procedure:**

1. Ensure that the inverter is disconnected from all voltage sources (see Section 9, page 96).
2. Remove the sealing plug from the opening for connecting the switch for secure power supply operation.
3. Insert the cable gland into the opening and tighten it with the counter nut from the inside.
4. Guide the conductors into the inverter.
5. Strip off the conductor insulation by min. 6 mm to max. 10 mm.
6. Connect the conductors to the 2-pole terminal blocks. Ensure that the conductors are plugged completely into the terminal points up to their insulation.

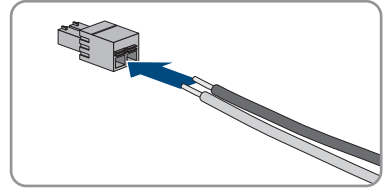

7. Stick the terminal block into the slot  on the battery interface module in the inverter.

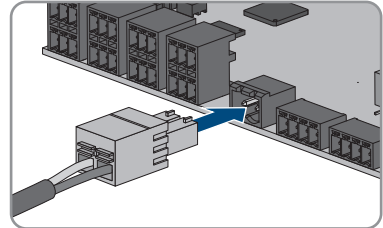

8. Ensure that the terminal block is securely in place.
9. Ensure that all conductors are correctly connected.
10. Ensure that the conductors sit securely in the terminal points. Tip: To release the conductors from the terminal block, open the terminal points using a suitable tool.
11. Install switch in desired position (e.g. next to the inverter or as switch/outlet combination optionally at short distance from the inverter (to max. 10 m)).
12. Connect the other end of the cable directly to the switch.

## 6.9 DC Connection

### 6.9.1 Possible Connection

The inverter includes the multi-battery function. This enables to charge and discharge several batteries of the same or different type.

Each DC terminal is designed for a maximum charging/discharging current of 10 A. You can choose between the following connection possibilities:

- Connection of one, two or three batteries with a charging/discharging current limit of 10 A each.
- Connection of two batteries: The first has a charging/discharging current limit of 20 A and the second 10 A.
- Connection of one single battery with a charging/discharging current limit of 20 A.

- Connection of one single battery with a charging/discharging current limit of 30 A.

In the following sections, you find detailed information as well as a wiring- and connection overview for each connection possibility.

### 6.9.1.1 Connection of batteries with a charging/discharging current limit of 10 A

You may connect one, two or three batteries with a charging/discharging current limit of 10 A each to the inverter:

**Procedure:**

Connect each battery to a DC terminal.

If there is only one battery available, the battery must be connected to the terminal blocks **A+** and **A-**.

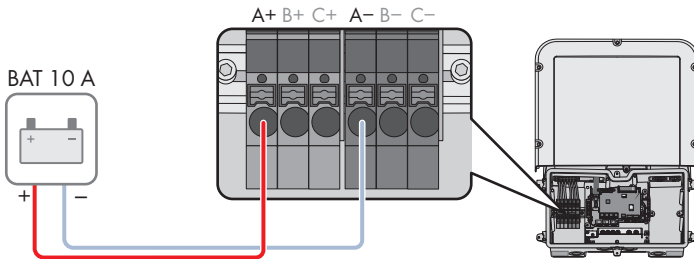

Figure 16: Overview for connection of one battery with a charging/discharging current limit of 10 A

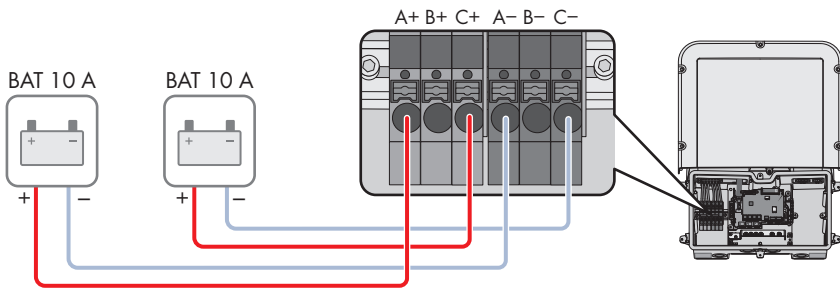

Figure 17: Overview for connection of two batteries with a charging/discharging current limit of 10 A each

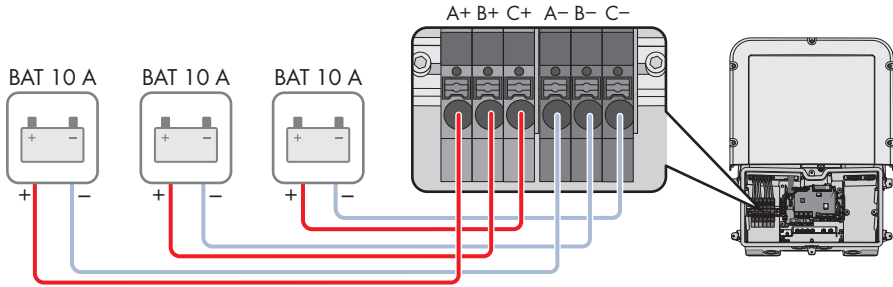

Figure 18: Overview for connection of three batteries with a charging/discharging current limit of 10 A each

### 6.9.1.2 Connection of two batteries with different charging/discharging currents

You may connect two batteries: The first has a charging/discharging current limit of 20 A and the second 10 A.

#### Procedure:

The DC terminals A and B must be switched parallelly using the jumpers provided.

The battery limited to a charging/discharging current of 20 A must be connected to the terminal blocks **A+** and **A-**.

The battery limited to a charging/discharging current of 10 A must be connected to the terminal blocks **C+** and **C-**.

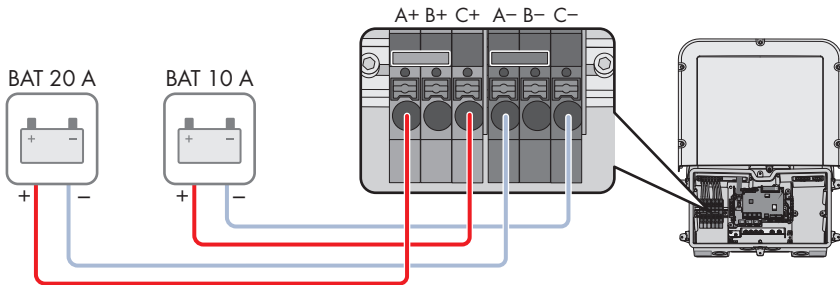

Figure 19: Overview for connection of two batteries with varying charging/discharging current limits

### 6.9.1.3 Connection of one battery with a charging/discharging current limit of 20 A

You may connect one battery with a charging/discharging current limit of 20 A each to the inverter.

#### Procedure:

The DC terminals A and B must be switched parallelly using the jumpers provided.

The battery must be connected to the terminal blocks **A+** and **A-**.

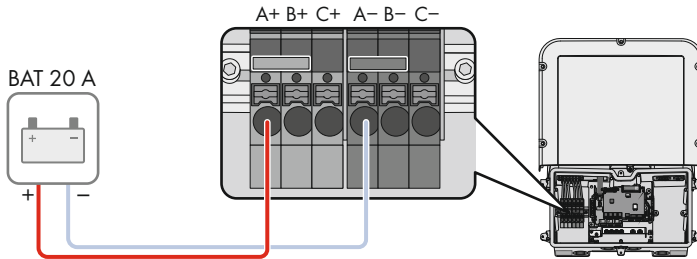

Figure 20: Overview for connection of one battery with a charging/discharging current limit of 20 A

#### 6.9.1.4 Connection of a battery with a charging/discharging current limit of 30 A

You may connect 1 battery with a charging/discharging current limit of 30 A each to the inverter.

##### Procedure:

All DC terminals must be switched parallelly with the jumpers provided.

The battery must be connected to the terminal blocks **A+** and **A-**.

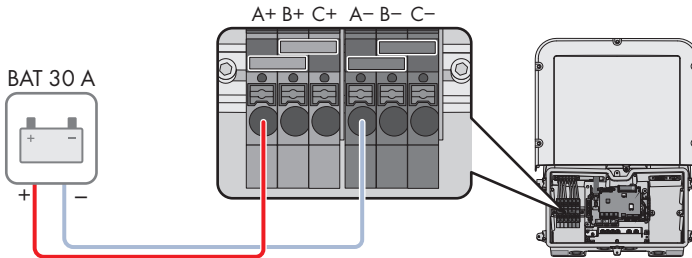

Figure 21: Overview for connection of one battery with a charging/discharging current limit of 30 A

## 6.9.2 Requirements for the DC Connection

### Fusing the DC terminals:

Each DC terminal is designed for a maximum charging/discharging current of 10 A. The conditional short-circuit current-carrying capacity of all DC inputs is 40 A.

As of firmware version 3.11.03.R, the inverter is equipped with a monitoring function of the DC input current. If the 40 A is exceeded, the battery is automatically disconnected for protection and the inverter goes into permanent operation inhibition. For batteries approved by SMA Solar Technology AG, even those with an output current > 40 A, additional fusing between the battery and the inverter is not mandatory. If additional protection is required by local laws, regulations or standards, it must be installed. Local regulations must be checked and complied with.

**Cable requirements:**

- Conductor cross-section: 2.5 mm<sup>2</sup> to 10 mm<sup>2</sup>
- Insulation stripping length: 12 mm
- The conductors must consist of copper.
- The conductors must be made of solid wire, stranded wire or fine stranded wire. When using fine stranded wire, bootlace ferrules must be used.
- Maximum cable length: 10 m

**6.9.3 Connecting the power cable of the battery****⚠ QUALIFIED PERSON****⚠ DANGER****Danger to life from electric shock due to live DC cables at the battery.**

The DC cables connected to a battery may be live. Touching the DC conductors or the live components leads to lethal electric shocks.

- Ensure that the inverter is disconnected from all voltage sources.
- Do not touch non-insulated cable ends.

**Procedure:**

1. Remove the adhesive tape from the enclosure opening for DC connection and, if other enclosure openings are to be used, take the sealing plugs out of these enclosure openings.
2. Insert the cable gland into the opening and tighten it with the counter nut from the inside.
3. Guide each cable into the inverter. In the process, lay each cable in such a way that they do not come into contact with the communication assembly.
4. Connect equipotential bonding of the battery to a grounding point:
  - Strip off the conductor insulation by 18 mm.
  - Insert the screw through the conical spring washer, the clamping bracket and the washer.
  - Put the conductor between the washer and clamping bracket and tighten the screw (TX 25, torque: 6 Nm ± 0.3 Nm). Here, the conductor must have contact with an inner edge of the clamping bracket.

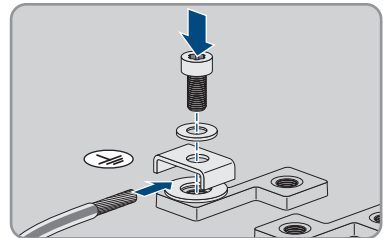



- If 2 conductors have to be connected to a grounding point, put both conductors between the washer and clamping bracket and tighten the screw (TX25, torque:  $6 \text{ Nm} \pm 0.3 \text{ Nm}$ ). Here, each conductor must have contact with an inner edge of the clamping bracket.

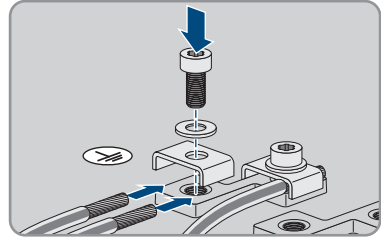

5. Strip off the DC conductor insulation.
6. Connect the cables according to the labeling. Insert each conductor into the corresponding terminal point.

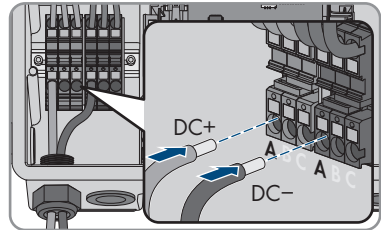

7. Ensure that the terminal points are allocated to the correct conductors.
8. Ensure that the conductors are plugged completely into the terminal points up to their insulation.

## 7 Commissioning

### 7.1 Commissioning Procedure

#### **⚠ QUALIFIED PERSON**

This section describes the commissioning procedure and gives an overview of the steps you must perform in the prescribed order.

#### **i Commissioning a product in SMA Energy Systems**

If the product is used in an SMA Energy System, the commissioning must be performed according to the manual of the SMA Energy System. The procedure and the sequence may differ from the steps described in this section.

- Commissioning an SMA Energy System (see system manual of the SMA Energy System).

#### **i Commissioning an inverter that is captured in a communication device**

When the inverter is captured in a communication device, the communication device (e.g. SMA Data Manager) is the unit for configuring the total system. The configuration is transferred to all inverters in the system. The system password assigned via the communication device is also the password for the user interface of the inverter.

- Commission the inverter (see Section 7.2, page 67).
- The initial configuration of the inverter is made via the communication device. The configuration is transferred to the inverter and the settings of the inverter are overwritten.
- Deactivate the Webconnect function of the inverter via the Sunny Portal. This prevents unnecessary connection attempts of the inverter with Sunny Portal.

Procedure	See
1. Commission the inverter.	Section 7.2, page 67
2. Establish a connection to the user interface of the inverter. There are various connection options to choose from for this: <ul style="list-style-type: none"> <li>• Direct connection via WLAN</li> <li>• Direct connection via Ethernet</li> <li>• Connection via WLAN in the local network</li> <li>• Connection via Ethernet in the local network</li> </ul>	Section 8.1, page 72
3. Log into the user interface.	Section 8.2, page 76
4. Select the inverter configuration option. Please note that the SMA Grid Guard code for changing the grid-relevant parameters must be available after completion of the first ten feed-in hours or installation assistant. You can request the SMA Grid Guard code via the Online Service Center.	Section 7.3, page 69

Procedure	See
5. Configure the product and set country data set. Then the product will begin operation.	Section 8.12, page 88
6. Make further inverter settings as needed.	Section 8, page 72

## 7.2 Commissioning the Inverter

### ⚠ QUALIFIED PERSON

### ⚠ WARNING

#### Danger to life due to fire or explosion when batteries are fully discharged

A fire may occur due to incorrect charging of fully discharged batteries. This can result in death or serious injury.

- Before commissioning the system, verify that the battery is not fully discharged.
- Do not commission the system if the battery is fully discharged.
- If the battery is fully discharged, contact the battery manufacturer for further proceedings.
- Only charge fully discharged batteries as instructed by the battery manufacturer.

#### Requirements:

- The AC circuit breaker must be correctly rated and mounted.
- The product must be correctly mounted.
- All cables must be correctly connected.
- Unused enclosure openings must be sealed tightly with sealing plugs.

#### Procedure:

1. Lead the enclosure lid to the Connection Unit and plug the ribbon cable into the socket on the communication assembly.

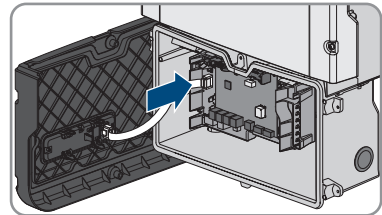

2. Ensure that the ribbon cable is securely plugged into the sockets at both ends.

3. Position the enclosure lid of the Connection Unit at an angle on the top edge, press down and tighten all 6 screws crosswise (TX25, torque:  $3 \text{ Nm} \pm 0.3 \text{ Nm}$ ).

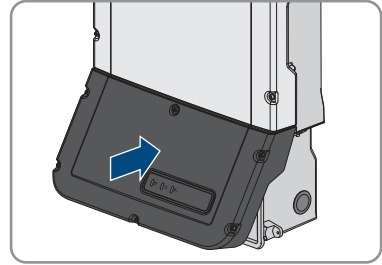

4. Switch on the AC circuit breaker.
5. Switch on the battery or the load-break switch of the battery (see documentation of the battery manufacturer).
  - All 3 LEDs light up. The start-up phase begins.
  - All 3 LEDs go out again after approximately 90 seconds.
  - Depending on the available power, the green LED pulses or is continuously illuminated. The inverter is feeding in.
6. If the LEDs do not start to glow, the ribbon cable between the assembly in the enclosure lid and the communication assembly in the inverter is most likely not properly plugged in. Ensure that the ribbon cable is securely plugged into the sockets at both ends.
7. If the green LED is still flashing, the conditions for activating feed-in operation are not yet met. As soon as the conditions for feed-in operation are met, the inverter starts with feed-in operation and, depending on the available power, the green LED will light up continuously or it will pulse.

## 7.3 Selecting a configuration option

### **⚠ QUALIFIED PERSON**

After you have assigned the password for the user groups **Installer** and **User** and logged in as **Installer**, the **Configuring the Inverter** page opens.

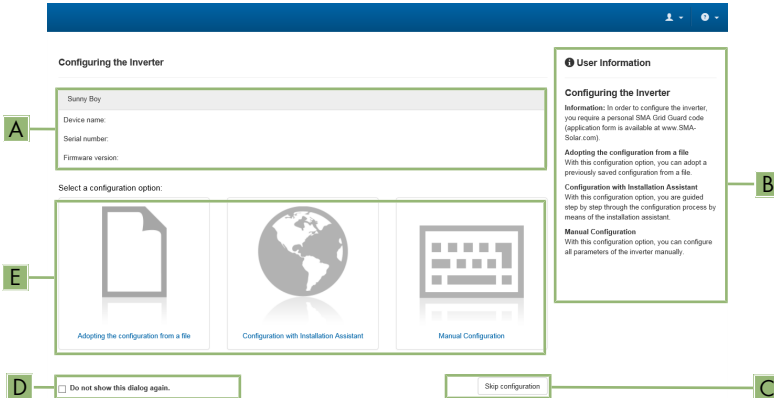

Figure 22: Layout of the **Configuring the Inverter** page

Position	Designation	Description
A	Device information	Provides the following information: <ul style="list-style-type: none"> <li>• Device name</li> <li>• Inverter serial number</li> <li>• Inverter firmware version</li> </ul>
B	User information	Provides brief information on the listed configuration options
C	Skip configuration	Offers the option of skipping the inverter configuration and going directly to the user interface (not recommended; the inverter cannot be operated without configuration)
D	Checkbox	Allows you to choose not to have the displayed page displayed again when the user interface is called up again
E	Configuration options	Provides a selection of the various configuration options

**Configuration options:**

On the **Configuring the Inverter** page, different configuration options are available to choose from. Select one of the options and proceed for the selected option as described below. SMA Solar Technology AG recommends carrying out the configuration with the installation assistant. This way, you ensure that all relevant parameters are set for optimal inverter operation.

- Adoption of configuration from a file
- Configuration with the installation assistant (recommended)
- Manual configuration

**Adopting the Configuration from a File**

You can adopt the inverter configuration from a file. To do this, there must be an inverter configuration saved to a file.

**Procedure:**

1. Select the configuration option **Adopting configuration from a file**.
2. Select [**Browse...**] and select the desired file.
3. Select [**Import file**].

**Configuring the Installation Assistant (Recommended)**

1. Select the configuration option **Configuration with Installation Assistant**.
  - The installation assistant will open.
2. Follow the installation assistant steps and make the settings appropriate for your system.
3. For every setting made in a step, select [**Save and next**].
  - In the last step, all made settings are listed in a summary.
4. To correct settings you made, select [**Back**], navigate to the desired step, correct settings and select [**Save and continue**].
5. Once all settings are correct, select [**Next**] in the summary.
6. To save the settings to a file, select [**Export a summary**] and save the file on your smart device.
7. To export all parameters and their settings, select [**Export all parameters**]. This exports all parameters and their settings into an HTML file.
  - The start page of the user interface opens.

**Manual configuration**

You can configure the inverter manually by setting the desired parameters.

**Procedure:**

1. Select the configuration option **Manual Configuration**.
  - The **Device Parameters** menu on the user interface will open and all available parameter groups of the inverter will be displayed.
2. Select [**Edit parameters**].
3. Select the desired parameter group.
  - All available parameters of the parameter group will be displayed.

4. Set the desired parameters.
  5. Select [**Save all**].
- The inverter parameters are set.

## 8 Operation

### 8.1 Establishing a connection to the user interface

#### 8.1.1 Establishing a Direct Connection via Ethernet

##### Requirements:

- The product must be commissioned.
- A smart device (e.g. laptop) with an Ethernet interface must be available.
- The product must be connected directly to the smart device.
- The respective latest version of one of the following web browsers must be installed on the smart device: Chrome, Edge, Firefox or Safari.
- The installer's SMA Grid Guard code must be available to change network-relevant settings after the first 10 hours of feed-in operation, or after completing the installation assistant. You can request the SMA Grid Guard code via the Online Service Center.

##### IP address of the inverter

- Standard inverter IP address for the direct connection via Ethernet: **169.254.12.3**

##### Procedure:

1. Open the web browser of your smart device and enter the IP address **169.254.12.3** in the address bar.

2.  **Web browser signals a security vulnerability**

After the IP address has been entered, a message might appear indicating that the connection to the user interface of the product is not secure. SMA Solar Technology AG guarantees the security of the user interface.

- Continue loading the user interface.

- The login page of the user interface opens.

#### 8.1.2 Establishing a direct connection via WLAN

You have several options to connect the product to a smart device. The procedure can be different depending on the devices. If the procedures described do not apply to your device, establish the direct connection via Wi-Fi as described in the manual of your device.

The following connection options are available:

- Connection to SMA 360° App
- Connection with WPS
- Connection with Wi-Fi network search

##### Requirements:

- The product must be commissioned.
- A smart device (e.g. smartphone, tablet or laptop) must be available.



- The respective latest version of one of the following web browsers must be installed on the smart device: Chrome, Edge, Firefox or Safari.
- JavaScript must be enabled in the web browser of the smart device.
- The installer's SMA Grid Guard code must be available to change network-relevant settings after the first 10 hours of feed-in operation, or after completing the installation assistant. You can request the SMA Grid Guard code via the Online Service Center.

### **i** SSID, IP address and WLAN password

- SSID in WLAN: **SMA[serial number]** (e.g. SMA0123456789)
- Device-specific WLAN password: see WPA2-PSK on the type label of the product or the rear side of the manual included in delivery
- Standard access address for a direct connection via WLAN outside of a local network: **https://smalogin.net** or **192.168.12.3**

### **i** Using serial number of inverter for connecting to user interface

The inverter serial number is on the supplementary type label. PIC and RID for registration in the Sunny Portal are also included there. The supplementary type label is attached to the Connection Unit.

- Use serial number on supplementary type label for connecting to user interface.

### **i** Importing and exporting files with smart devices having an iOS operating system is not possible

For technical reasons, importing and exporting files (e.g., importing an inverter configuration, saving the current inverter configuration or exporting events and parameters) is not possible with smart devices having an iOS operating system.

- Use a smart device that does not have an iOS operating system for importing and exporting files.

## Connection to SMA 360° App

### Requirements:

- A smart device with camera (e.g. smartphone or tablet) must be available.
- The SMA 360° App must be installed on the smart device.
- An user account for Sunny Portal must already exist.

### Procedure:

1. Open the SMA 360° App and login with the Sunny Portal account details.
2. Select **QR-Code Scan** in the menu.
3. Scan the QR Code on your product via the SMA 360° App.
  - The smart device automatically connects to the product. The web browser of your smart device opens and the login page of the user interface is displayed.
4. If the web browser of the smart end device does not open automatically and the login page of the user interface is not displayed, open the web browser and enter **https://smalogin.net** in the address bar.

## Connection with WPS

### Requirement:

- The smart device must have a WPS function.

### Procedure:

1. Enable the WPS function on the inverter. To do this, tap twice on the enclosure lid of the Connection Unit.
  - The blue LED flashes quickly for approx. two minutes. The WPS function is active during this time.
2. Enable the WPS function on your smart device.
3. Open the web browser of your smart end device and enter **https://smalogin.net** in the address bar.

## Connection with Wi-Fi network search

1. Search for Wi-Fi networks with your smart device.
2. Select the SSID of the product **SMA[serial number]** in the list with the detected Wi-Fi networks.
3. Enter the device-specific Wi-Fi password (see WPA2-PSK on the type label of the product or the rear side of the manual included in delivery).
4. Open the web browser of your smart end device and enter **https://smalogin.net** in the address bar.
  - The login page of the user interface is displayed.
5. If the login page of the user interface does not open, enter the IP address **192.168.12.3** or, if your smart end device supports mDNS services, **SMA[serial number].local** or **https://SMA[serial number]** in the address bar of the web browser.

### 8.1.3 Establishing a Connection via Ethernet in the local network

#### New IP address for connecting with a local network

If the product is connected to a local network (e.g. via a router), the product will receive a new IP address. Depending on the type of configuration, the new IP address will be assigned automatically by the DHCP server (router) or manually by you. Upon completion of the configuration, the product can only be reached via the following access addresses:

- Generally applicable access address: IP address manually assigned or assigned by the DHCP server (router) (identification via network scanner software or network configuration of the router).
- Access address for Apple and Linux systems: **SMA[serial number].local** (e.g. SMA0123456789.local)
- Access address for Windows and Android systems: **https://SMA[serial number]** (e.g. https://SMA0123456789)

**Requirements:**

- The product must be connected to the local network via a network cable (e.g. via a router).
- The product must be integrated into the local network. Tip: There are various methods of integrating the product into the local network with the aid of the installation assistant.
- A smart device (e.g. smartphone, tablet or laptop) must be available.
- The smart device must be in the same local network as the product.
- The respective latest version of one of the following web browsers must be installed on the smart device: Chrome, Edge, Firefox or Safari.
- The installer's SMA Grid Guard code must be available to change network-relevant settings after the first 10 hours of feed-in operation, or after completing the installation assistant. You can request the SMA Grid Guard code via the Online Service Center.

**Procedure:**

1. Open the web browser of your smart device. Enter the IP address of the product in the address bar of the web browser.
  2.  **Web browser signals a security vulnerability**  
After the IP address has been entered, a message might appear indicating that the connection to the user interface of the product is not secure. SMA Solar Technology AG guarantees the security of the user interface.
    - Continue loading the user interface.
- The login page of the user interface opens.

## 8.1.4 Establishing a Connection via WLAN in the Local Network

### New IP address for connecting with a local network

If the product is connected to a local network (e.g. via a router), the product will receive a new IP address. Depending on the type of configuration, the new IP address will be assigned automatically by the DHCP server (router) or manually by you. Upon completion of the configuration, the product can only be reached via the following access addresses:

- Generally applicable access address: IP address manually assigned or assigned by the DHCP server (router) (identification via network scanner software or network configuration of the router).
- Access address for Apple and Linux systems: **SMA[serial number].local** (e.g. SMA0123456789.local)
- Access address for Windows and Android systems: **https://SMA[serial number]** (e.g. https://SMA0123456789)

**Requirements:**

- The product must be commissioned.
- The product must be integrated into the local network. Tip: There are various methods of integrating the product into the local network with the aid of the installation assistant.
- A smart device (e.g. smartphone, tablet or laptop) must be available.
- The smart device must be in the same local network as the product.

- The respective latest version of one of the following web browsers must be installed on the smart device: Chrome, Edge, Firefox or Safari.
- The installer's SMA Grid Guard code must be available to change network-relevant settings after the first 10 hours of feed-in operation, or after completing the installation assistant. You can request the SMA Grid Guard code via the Online Service Center.

### **i** Importing and exporting files with smart devices having an iOS operating system is not possible

For technical reasons, importing and exporting files (e.g., importing an inverter configuration, saving the current inverter configuration or exporting events and parameters) is not possible with smart devices having an iOS operating system.

- Use a smart device that does not have an iOS operating system for importing and exporting files.

#### **Procedure:**

- Enter the IP address of the product in the address bar of the web browser.
  - The login page of the user interface opens.

## 8.2 Logging In and Out of the User Interface

After a connection to the user interface of the inverter has been established, the login page opens. Log onto the user interface as described below.

### **i** Usage of cookies

For the correct display of the user interface, cookies are required. The cookies are used for convenience only. By using this user interface you agree to the placement of cookies.

#### **Log in as Installer or User for the First Time**

### **i** Password assignment for user and installer

The passwords for the user groups **Installer** and **User** must be assigned when accessing the user interface for the first time. If the inverter was registered in a communication device (e.g., SMA Data Manager) and the system password was assigned, the system password is also the installer password. In this case, only the user password must be assigned.

- If you as a specialist assign the user password, only pass the password on to persons to access the inverter data via the user interface.
- If you as a user assign the installer password, only pass the password on to persons to receive access to the system.

### **i** Installer password for inverters registered in a communication device or in Sunny Portal

To be able to register the inverter in a communication device (e.g., SMA Data Manager) or in a Sunny Portal system, the password for the user group **Installer** must match the system password. If you assign a password for the user group **Installer** via the user interface of the inverter, the same password must also be used as the system password.

- Assign a uniform installer password to all SMA devices in the system.

**Procedure:**

1. In the drop-down list **Language**, select the desired language.
  2. In the **Password** field, enter a password for the **User** user group.
  3. In the **Repeat password** field, enter the password again.
  4. Click on **Save**.
  5. In the **New password** field, enter a password for the **Installer** user group. Assign a uniform password to all SMA devices to be registered in a system. The installer password is also the system password.
  6. In the **Repeat password** field, enter the password again.
  7. Click on **Save and log in**.
- The **Configuring the Inverter** page opens.

**Log in as the User or Installer**

1. In the drop-down list **Language**, select the desired language.
  2. In the **User group** drop-down list, select the entry **Installer** or **User**.
  3. Enter the password in the field **Password**.
  4. Select **Login**.
- The start page of the user interface opens.

**Log Out as the User or Installer**

1. On the right-hand side of the menu bar, select the menu **User Settings**.
  2. In the subsequent context menu, select [**Logout**].
- The login page of the user interface opens. The logout was successful.

### 8.3 Start Page Design of the User Interface

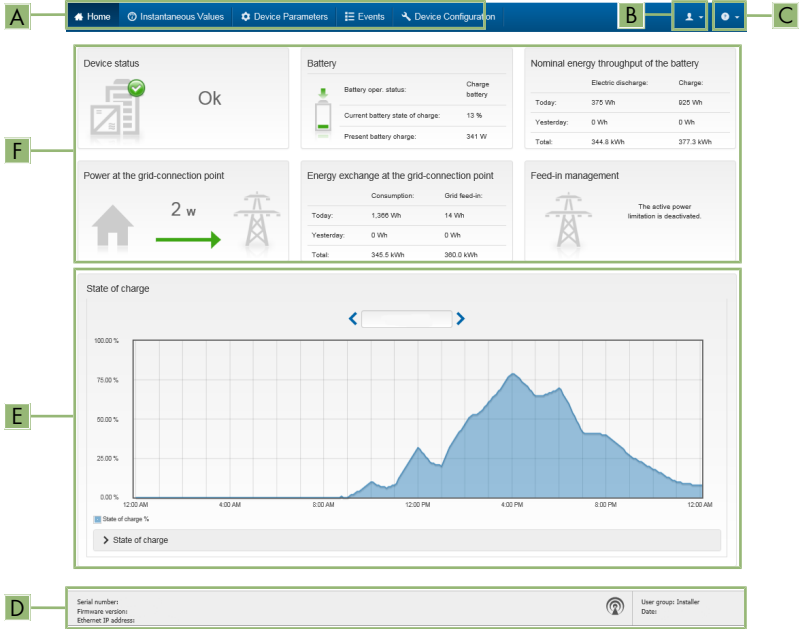

Figure 23: Design of the user interface's home page (example)

Position	Designation	Description
A	Menu	<p>Provides the following functions:</p> <ul style="list-style-type: none"> <li>• <b>Home</b> Opens the user interface homepage</li> <li>• <b>Instantaneous values</b> Current measured values of the inverter</li> <li>• <b>Device Parameters</b> The various operating parameters of the inverter can be viewed and configured here depending on the user group.</li> <li>• <b>Events</b> All events that have occurred in the selected time period are displayed here. The event types are <b>Information</b>, <b>Warning</b> and <b>Error</b>. Currently existing events of the types <b>Error</b> and <b>Warning</b> will be additionally displayed in the <b>Device status</b> viewlet. However, only the higher-priority event is displayed. If, for example, there is a Warning and an Error present at the same time, only the Error will be displayed.</li> <li>• <b>Device configuration</b> Various settings for the inverter can be made here. The selection available is dependent on which user group you are logged in as and the operating system of the device with which the user interface has been called up.</li> <li>• <b>Data</b> You will find all data that is saved in the internal memory of the inverter or on an external storage medium on this page.</li> </ul>
B	User settings	<p>Provides the following functions, depending on the user group logged in:</p> <ul style="list-style-type: none"> <li>• Starting the installation assistant</li> <li>• SMA Grid Guard login</li> <li>• Logout</li> </ul>
C	Help	<p>Provides the following functions:</p> <ul style="list-style-type: none"> <li>• Displaying information on Open Source licenses used</li> <li>• Link to the website of SMA Solar Technology AG</li> </ul>

Position	Designation	Description
D	Status bar	Displays the following information: <ul style="list-style-type: none"><li>• Inverter serial number</li><li>• Inverter firmware version</li><li>• IP address of the inverter within the local network and/or IP address of the inverter during WLAN connection</li><li>• With WLAN connection: Signal strength of WLAN connection</li><li>• User group logged in</li><li>• Date and device time of the inverter</li></ul>

---



Position	Designation	Description
E	State of charge	<p>Chronological sequence of the state of charge (SOC) of the battery</p> <p>This value may be different from the values that the battery provides. Only the value supplied by the inverter is used for this purpose.</p>
F	Status display	<p>The various areas display information on the current status of the system.</p> <ul style="list-style-type: none"> <li>• <b>Device status</b> Displays whether the inverter and/or the battery is/are currently in a fault-free operating state or whether there is an event type <b>Error</b> or <b>Warning</b> present.</li> <li>• <b>Feed-in management</b> Displays whether the inverter is currently limiting its active power.</li> <li>• <b>Nominal energy throughput of the battery</b> Indicates how much energy has been charged to the battery and how much has been discharged from the battery.</li> <li>• <b>Battery</b> Displays the following information: <ul style="list-style-type: none"> <li>- Operating status of battery</li> <li>- Current battery state of charge</li> <li>- Current battery charging power</li> </ul> </li> <li>• <b>Energy exchange at the grid-connection point</b> Indicates how much energy was obtained from the utility grid to supply the household and how much the PV system fed in.</li> <li>• <b>Power at the grid connection point</b> Indicates which power is currently fed in or obtained at the grid-connection point.</li> </ul>

## 8.4 Displaying and Downloading the Stored Data

If an external storage device is plugged in, you can display and download the stored data.

### Procedure:

1. Activate the user interface (see Section 8.1, page 72).
2. Log into the user interface (see Section 8.2, page 76).
3. Select the menu **Data**.
4. Select the folder **Data**.

5. To call up the data, select the respective folder and click on the required file.
6. To download the data, select the data type to be exported in the drop-down list. Then apply the time filter and select **Data export**.

## 8.5 Starting the Installation Assistant

### **⚠ QUALIFIED PERSON**

The installation assistant leads you step-by-step through the steps necessary for the initial configuration of the inverter.

#### Layout of the installation assistant

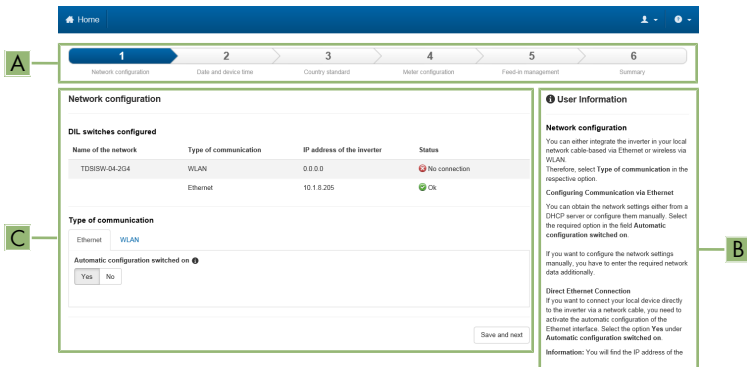

Figure 24: Layout of the installation assistant (example)

Position	Designation	Description
A	Configuration steps	Overview of the installation assistant steps. The number of steps depends on the type of device and the additionally installed modules. The current step is highlighted in blue.
B	User information	Information about the current configuration step and the setting options of the configuration step.
C	Configuration field	You can make settings in this field.

#### Requirement:

- The SMA Grid Guard code must be available to change network-relevant parameters after the first 10 hours of feed-in operation, or after completing the installation assistant. You can request the SMA Grid Guard code via the Online Service Center.

#### Procedure:

1. Open the user interface (see Section 8.1, page 72).
2. Log in as **Installer**.

3. Select the menu **User Settings** (see Section 8.3, page 78) on the start page of the user interface.
  4. In the context menu, select [**Starting the installation assistant**].
- The installation assistant will open.

## 8.6 Secure power supply operation

If an electrical outlet and a switch for secure power supply operation are connected to the inverter, you can supply a load with energy from the battery in case of a grid failure.

The secure power supply operation is not automatically enabled in the event of a grid failure, neither is it automatically disabled once the utility grid is available again. If the utility grid fails, the load supply must be enabled manually by activating the switch. The inverter automatically regulates the energy supply of the outlet after activating the switch. When the utility grid is available again and the load can be supplied by this again, the secure power supply operation must be disabled manually by switching the switch off.

If you enable the secure power supply operation, the inverter supplies the loads that are connected to the outlet for secure power supply operation until the battery's state of charge (SOC) has reached the lower limit. In case the battery's state of charge (SOC) is too low, the energy supply of the outlet is permanently interrupted. The lower state of charge limit can be modified by setting a parameter. The lower limit is 0% by default. The secure power supply operation runs only when the battery can be recharged after connecting to the utility grid.

In case of overload, the energy supply of the outlet is briefly interrupted. The inverter automatically attempts to reestablish the energy supply 20 seconds after the interruption. This can lead to inadvertent starting of the load that is connected to the outlet. Ensure that the load connected to the outlet does not consume too much power. If necessary, reduce the power consumption of the load. During active secure power supply operation, the inverter is disconnected from the building's main electrical system and does not therefore feed into the utility grid. During secure power supply operation, the load can only be supplied with energy as long as there is stored energy available in the battery. If there is insufficient energy available from the battery, the secure power supply operation remains active, even if the utility grid is available again. Switching over to supplying the load from the utility grid is not carried out automatically. Once the battery is sufficiently recharged and the load can be supplied, the secure power supply operation must be restarted.

### **i** Secure power supply operation in Flexible Storage Systems with backup power supply not possible

If the inverter is used in a battery-backup system and connected with an automatic transfer switch, the secure power supply operation is not available.

### **i** Do not connect any loads that require an uninterrupted energy supply

The secure power supply operation and the battery-backup operation may not be used for loads that require an uninterrupted energy supply. The energy that is available during the secure power supply operation or battery-backup operation depends on the battery capacity available and the state of charge of the battery (SOC).

- Do not connect loads if they are dependent on an uninterrupted energy supply for reliable operation.

### 8.6.1 Enable secure power supply operation

To supply the loads with energy in the event of utility grid failure, you can enable the secure power supply operation as follows.

To check the secure power supply operation, proceed as described in this section. Disable the secure power supply operation afterwards (see Section 8.6.2, page 84).

#### Procedure:

1. If no load is connected to the outlet, connect a load.
2. Turn the switch of the outlet to secure power supply operation.
3. Wait one minute.
  - The inverter commences secure power supply operation. Once the inverter supplies the outlet, the green LED flashes (1.5 s on and 0.5 s off).
4. If the green LED is not flashing, it is likely that the battery's state of charge (SOC) is too low and the following steps must be performed:
  - Ensure that the outlet's switch is set to secure power supply operation.
  - Connect a load with lower power consumption to the outlet.
5. If no voltage can be measured at the outlet, ensure that the switch of the outlet is set to secure power supply operation, and that the switch, outlet and control light for secure power supply operation are correctly connected.

### 8.6.2 Disable secure power supply operation

1. If necessary, disconnect the load from the outlet.
2. Turn the switch of the outlet to grid operation.
  - Grid operation is activated.
- The inverter connects to the utility grid and starts feed-in operation.

## 8.7 Checking or Disabling Battery-Backup Operation

You may check the battery-backup operation. This ensures that the battery-backup system works and provides a battery-backup grid in the event of utility grid failure.

The basic procedure for changing operating parameters is explained in another section (see Section 8.11, page 86).

#### Procedure:

1. Select the parameter **Backup box operating mode** and set it to **Force**.
  - The battery-backup operation is started.
2. To ensure that the battery-backup system works, proceed as follows: check loads, select the menu **[Results]** and check whether a battery-backup system error is displayed. During battery-backup operation, the loads must be supplied with energy from the battery-backup system. If the loads are supplied with energy, an error has occurred. If an error is displayed in the menu **[Results]**, it must be fixed.

3. To finish the check, set the parameter **Backup box operating mode** to **Auto**.
4. To disable the battery-backup operation, set the parameter **Backup box operating mode** to **Off**. The battery-backup operation is disabled until it is re-enabled manually. The battery-backup operation is enabled when it is set to **Auto**.

## 8.8 Activate WPS Function

The WPS function can be used for different purposes:

- Automatic connection to a network (e.g. via router)
- Direct connection between the product and a smart device

Depending on the intended application of the WPS function, the procedure for activation will vary.

### Activating WPS function for automatic connection to a network

#### Requirements:

- WLAN must be activated in the product.
- WPS must be activated on the router.

#### Procedure:

1. Open the user interface (see Section 8.1, page 72).
  2. Log in as **Installer**.
  3. Start the installation assistant (see Section 8.5, page 82).
  4. Select **Network configuration**.
  5. Select **WPS for WLAN network** button in the **WLAN** tab.
  6. Select **Activate WPS**.
  7. Select **Save and next** and exit the installation assistant.
- The WPS function is activated and the automatic connection to the network can be established.

### Activating the WPS function for direct connection to the smart device.

- Activate the WPS function on the inverter. To do this, tap twice on the enclosure lid of the Connection Unit.
  - The blue LED flashes quickly for approx. two minutes. The WPS function is active during this time.

## 8.9 Switching WLAN On and Off

The inverter is equipped with an activated WLAN interface as standard. If you do not want to use WLAN, you can switch the WLAN function off and switch it on again whenever needed. In doing so, you can switch the WLAN direct connection and the WLAN connection in the local network on independently of each other.

### Switching on the WLAN function only possible via Ethernet connection

If you switch off both the WLAN function for the direct connection and for the connection in the local network, access to the inverter user interface and therefore reactivation of the WLAN interface is only possible via an Ethernet connection.

The basic procedure for changing operating parameters is explained in another section (see Section 8.11, page 86).

## Switching WLAN Off

If you would like to switch the WLAN function off completely, you must switch off both the direct connection and the connection in the local network.

### Procedure:

- To switch off the direct connection in the parameter group **PV system communication > WLAN**, select the parameter **Soft-access-point is turned on** and set this to **No**.
- To switch off the connection in the local network in the parameter group **PV system communication > WLAN**, select the parameter **WLAN is turned on** and set this to **No**.

## Switching WLAN On

If you have switched the WLAN function for direct connection or for connection in the local network off, you can switch the WLAN function back on in accordance with the following procedure.

### Requirement:

- If the WLAN function was previously switched off completely, the inverter must be connected to a computer or router via Ethernet.

### Procedure:

- To switch on the WLAN direct connection, in the parameter group **PV system communication > WLAN**, select the parameter **Soft-access-point is turned on** and set this to **Yes**.
- To switch on the WLAN connection in the local network, in the parameter group **System communication > WLAN**, select the parameter **WLAN is turned on** and set this to **Yes**.

## 8.10 Changing the Password

The password for the product can be changed for both user groups. Furthermore, the user group **Installer** can change the password for the user group **User** as well as its own password.

### Procedure:

1. Open the user interface (see Section 8.1, page 72).
2. Log into the user interface (see Section 8.2, page 76).
3. Call up the menu **Device parameters**.
4. Click on **[Edit parameters]**.
5. In the parameter group **User Rights > Access Control** change the password of the desired user group.
6. Select **[Save all]** to save the changes.

## 8.11 Changing Operating Parameters

The operating parameters of the inverter are set to certain values by default. You can change the operating parameters to optimize the performance of the inverter.

This section describes the basic procedure for changing operating parameters. Always change operating parameters as described in this section.

Some function-sensitive parameters can only be viewed by qualified persons and can only be changed by qualified persons by entering the personal SMA Grid Guard code. You can request the SMA Grid Guard code via the Online Service Center.

### Requirements:

- Changes to grid-relevant parameters must be approved by the responsible grid operator.

### Procedure:

1. Open the user interface (see Section 8.1, page 72).
  2. Log into the user interface (see Section 8.2, page 76).
  3. Call up the menu **Device parameters**.
  4. Click on [**Edit parameters**].
  5. Log in using the SMA Grid Guard code to change those parameters designated by a lock (only for installers):
    - Select the menu **User settings** (see Section 8.3, page 78).
    - In the subsequent context menu, select [**SMA Grid Guard login**].
    - Enter the SMA Grid Guard code and select [**Login**].
  6. Expand the parameter group that contains the parameter which is to be configured.
  7. Change the required parameters.
  8. Select [**Save all**] to save the changes.
- The parameters are set.

### Accepting the settings

Saving the made settings is indicated by an hourglass symbol on the user interface. If the DC voltage is sufficient, the data is transferred directly to the inverter and accepted. If the DC voltage is too low (e.g. when the battery is switched off), the settings are saved, but they cannot be directly transferred to or accepted by the inverter. As long as the inverter has not yet received and accepted the settings, the hourglass symbol will continue to be displayed on the user interface. The settings will be accepted when there is sufficient DC voltage applied and the inverter restarts. As soon as the hourglass symbol appears on the user interface, the settings have been saved. The settings will not be lost. You can log off of the user interface and leave the system.

## 8.12 Configuring the Country Data Set

### ⚠ QUALIFIED PERSON

#### **i** Change to the names and units of grid parameters to comply with the grid-connection requirements in accordance with Regulation (EU) 2016/631 (valid from April 27, 2019)

To comply with the EU grid-connection requirements (valid from April 27, 2019) the names and units of grid parameters were changed. This change is valid from firmware version  $\geq 3.00.00.R$  if a country data set for fulfilling the EU grid-connection requirements (valid from 2019-04-27) is set. Names and units of grid parameters for inverters with firmware version  $\leq 2.99.99.R$  are not affected by this change and remain valid. This also applies from firmware version  $\geq 3.00.00.R$  if a country data set that is valid for countries outside the EU is set.

The basic procedure for changing operating parameters is explained in another section (see Section 8.11, page 86).

#### Procedure:

- In the parameter group **Grid monitoring > Grid monitoring** select the parameter **Set country standard** and set the required country data set.

## 8.13 Configuring the Active Power Mode

### ⚠ QUALIFIED PERSON

#### Starting the installation assistant

1. Open the user interface (see Section 8.1, page 72).
2. Log in as **Installer**.
3. Start the installation assistant (see Section 8.5, page 82).
4. Select [**Save and continue**] after each step up until the step **Grid management service**.
5. Make the settings as described in the following.

#### Setting the connected line conductors

- In the tab **Active power mode**, select the line conductor to which the inverter is connected from the drop-down list **Connected line conductors**.

#### Make the settings for systems with manual setpoint

1. In the tab **Active power mode** set the switch **Grid connection point regulation** to [**On**].
2. Enter the total PV array power in the field **Nominal PV system power**.
3. In the drop-down list **Operating mode active power setting**, select whether active power setting is to be performed via a fixed specification in percent or in watts.
4. In the field **Set active power limit**, enter the value to which the active power at the grid-connection point is to be specified. The value must be set to **0** for zero power output.

#### Make the settings for systems with external setpoint

- In the tab **Active power mode** set the switch **Grid connection point regulation** to [**Off**].



## Activating unbalanced load limitation

Depending on the country data set, unbalanced load limitation may have already been set. In this case, check the settings.

- If there are single-phase PV inverters in the system and unbalanced load limitation is requested, set **Unbalanced load limitation** to **[On]** and enter the maximum permissible unbalanced load in the field **Maximum unbalanced load**.
- If there are three-phase PV inverters in the system, set **Unbalanced load limitation** to **[Off]**.

## Configuring the Active Power Mode of the PV Inverters

1. Activate the PV inverter user interface.
2. Log in as **Installer**.
3. Start the installation assistant on the PV inverter user interface.
4. Select **[Save and continue]** until the step **Grid management service**.
5. Ensure that the function **Active power setpoint** is set to **[On]**.
6. In the drop-down list **Operating mode active power**, select the entry **External setpoint**.
7. In the drop-down list **Fallback behavior**, select the entry **Apply fallback values**.
8. In the field **Fallback value of the maximum active power** enter the value to which the inverter is to limit its nominal power in case of a communication failure to the higher control unit at the end of the timeout time.
9. In the field **Timeout**, enter the time that the inverter is to wait before it limits its nominal power to the set fallback value.
10. If, in the event of a 0% or 0 W specification, the inverter is not permitted to feed small amounts of active power into the utility grid, select the entry **Yes** in the drop-down list **Grid disconnection for 0% active power setpoint**. This ensures that in the event of a 0% or 0 W specification, the inverter disconnects from the utility grid and does not feed in active power.

## 8.14 Configuring Battery and Automatic Transfer Switching Device

When a battery is replaced or a new battery is added, and when the system is upgraded with an automatic transfer switching device to a battery-backup system or an existing automatic transfer switching device is replaced, the new components must be reconfigured as described below.

### Procedure:

1. Open the user interface (see Section 8.1, page 72).
2. Log in as **Installer**.
3. Start the installation assistant (see Section 8.5, page 82).
4. Click on **[Save and next]** for each step up to the step **Battery configuration**.
5. Click on the button **New configuration Battery / backup power supply**.
  - New components are detected. The detection process may take several minutes. Wait until all the connected batteries are detected and shown in the overview.
6. In case of battery-backup systems, make the settings in the **Battery-backup system** step. For this purpose, all batteries connected to the inverter must be shown in the overview.

## 8.15 Disabling Battery Charging by PV System in Battery-Backup Operation Mode

Depending on the state of charge in terms of battery and PV generation, it can happen that the battery-backup grid is interrupted for a few seconds in battery-backup operation mode during load changes and then restarts again. To prevent this behavior, you must make the following settings.

The basic procedure for changing operating parameters is explained in another section (see Section 8.11, page 86).

### Procedure:

1. Select the parameter **Output power limitation of PV inverter** and set it to **Permanently derated**.
2. Set the parameter **Upper limit for the charging state for derating of the PV inverters** to **0**.

## 8.16 Configuring the Modbus Function

### QUALIFIED PERSON

The Modbus interface is deactivated by default and the communication ports 502 set.

In order to access SMA inverters with SMA Modbus<sup>®</sup> or SunSpec<sup>®</sup> Modbus<sup>®</sup>, the Modbus interface must be enabled. After enabling the interface, the communication ports of both IP protocols can be changed. For information on commissioning and configuration of the Modbus interface, see the technical information "SMA and SunSpec Modbus<sup>®</sup> Interface" at [www.SMA-Solar.com](http://www.SMA-Solar.com).

For information on which Modbus registers are supported, see the technical information "Modbus<sup>®</sup> parameters and measured values" at [www.SMA-Solar.com](http://www.SMA-Solar.com).

### Measures for data security during activated Modbus interface

If you activate the Modbus interface, there is a risk that unauthorized users may access and manipulate the data or devices in your PV system.

To ensure data security, take appropriate protective measures such as:

- Set up a firewall.
- Close unnecessary network ports.
- Only enable remote access via VPN tunnel.
- Do not set up port forwarding at the communication port in use.
- In order to deactivate the Modbus interface, reset the inverter to the default settings or deactivate the activated parameter again.

### Deactivate the dynamic active power limitation for the PV inverters when controlled via Modbus

If the PV inverters and the battery inverter are controlled in a PV system via Modbus, the dynamic active power limitation of the PV inverters must be deactivated.

**Procedure:**

- Activate the Modbus interface and adjust the communication ports if necessary (see the technical information "SMA and SunSpec Modbus® Interface" at [www.SMA-Solar.com](http://www.SMA-Solar.com)).

## 8.17 Activating the Receipt of Control Signals (Only for Italy)

### QUALIFIED PERSON

In order for PV systems in Italy to receive control commands from the grid operator, set the following parameters.

The basic procedure for changing operating parameters is explained in another section (see Section 8.11, page 86).

Parameter	Value/range	Resolution	Default
Application ID	0 to 16384	1	16384
GOOSE-Mac address	01:0C:CD:01:00:00 to 01:0C:CD:01:02:00	1	01:0C:CD:01:00:00

**Procedure:**

1. Select the parameter group **External communication > IEC 61850 configuration**.
  2. In the field **Application ID**, enter the application ID of the grid operator gateway. You will receive this value from your grid operator. You can enter a value between 0 and 16384. The value 16384 indicates "deactivated".
  3. In the field **GOOSE-Mac address**, enter the MAC address of the grid operator gateway from which the inverter is to receive the control commands. You will receive this value from your grid operator.
- The receipt of control signals from the grid operator is activated.

## 8.18 Deactivating Grounding Conductor Monitoring

### QUALIFIED PERSON

If the inverter is to be installed in an IT network or another grid configuration in which deactivation of the grounding conductor monitoring is required, deactivate the grounding conductor monitoring as follows.

The basic procedure for changing operating parameters is explained in another section (see Section 8.11, page 86).

**Procedure:**

- In the parameter group **Grid monitoring > Grid monitoring > Country standard** set the parameter **PE connection monitoring** to **Off**.

## 8.19 Configuring the Energy Meter

You can add an energy meter to your PV system or replace an existing energy meter.

The basic procedure for changing operating parameters is explained in another section (see Section 8.11, page 86).

### Removing a detected energy meter from the PV system

If only one energy meter is detected by the inverter, this will be added to the PV system automatically. Removal via the menu **Device configuration** is not possible in this case. To remove the energy meter from the PV system, proceed as follows:

- In the parameter group **System communication > Measured values > Meter on Speedwire**, set the parameter **Serial number** to any number (e.g. **1**). In this way, instead of the energy meter detected, the PV system will add a fictitious energy meter to which the inverter cannot establish communication.

#### Procedure:

1. Activate the user interface (see Section 8.1, page 72).
2. Log in as **Installer**.
3. Start the installation assistant (see Section 8.5, page 82).
4. In the context menu, select [**Starting the installation assistant**].
5. Select [**Save and next**] until you get to the step **Meter configuration**.
6. Add or replace the desired energy meter.

## 8.20 Saving the Configuration in a File

#### Procedure:

1. Open the user interface (see Section 8.1, page 72).
2. Log into the user interface (see Section 8.2, page 76).
3. Select the menu **Device Configuration**.
4. Select [**Settings**].
5. In the context menu, select [**Saving the configuration in a file**].
6. Follow the instructions in the dialog.

## 8.21 Adopting a Configuration from a File

### QUALIFIED PERSON

To configure the inverter, you can adopt the configuration from a file. To be able to do this, you must first save the configuration of another inverter from the same type or device family in a file (see Section 8.20, page 92). When saving, only the device parameters will be adopted, not any passwords.

#### Requirements:

- Changes to grid-relevant parameters must be approved by the responsible grid operator.

- The SMA Grid Guard code must be available. You can request the SMA Grid Guard code via the Online Service Center.

**Procedure:**

1. Open the user interface (see Section 8.1, page 72).
2. Log into the user interface as an **Installer** (see Section 8.2, page 76).
3. Select the menu **Device Configuration**.
4. Select **[Settings]**.
5. In the context menu, select **[Adopting the configuration from a file]**.
6. Follow the instructions in the dialog.

## 8.22 Firmware Update

If no automatic update is set for the inverter in the communication product (e.g. SMA Data Manager, Cluster Controller, Sunny Portal) or via the user interface of the inverter, you have the option of carrying out a manual firmware update.

Depending on the battery used, the firmware update of the inverter also updates the battery.

You have the following options to update the firmware:

- Automatic Firmware Update (Recommended)
- Update the firmware with the existing update file via the user interface of the inverter.
- Update the firmware with the existing update file via USB flash drive.
- Search and install the firmware via the user interface of the inverter.

### **i Faulty firmware update due to disconnecting the inverter from the utility grid or when the battery is disconnected or discharged.**

The inverter must be connected to the utility grid and the battery must be switched on during the firmware update. The state of charge must be at least 5%. The battery-backup and secure power supply operation must be disabled. This ensures a proper firmware update.

- Ensure that the battery is switched on and the state of charge is above 5%.
- Do not disconnect the inverter from the utility grid during the firmware update.
- Do not enable secure power supply operation during the firmware update.
- Do not use the black-start button during the firmware update.

### 8.22.1 Activating Automatic Firmware Update

#### **⚠ QUALIFIED PERSON**

You can activate the automatic firmware update in the inverter or in the communication product.

If the automatic firmware update is activated in the inverter, the inverter searches for updates and carries out the update.

If the automatic firmware update is activated in the communication product, the communication product searches for updates for the inverter and carries out the update of the inverter. In this case, the automatic firmware update is deactivated by default in the inverter. This prevents multiple downloads of updates.

In this section we describe how to activate the automatic firmware update in the inverter. The procedure for activating the automatic firmware update for detected devices in the communication product can be found in the manual for the communication product.

The basic procedure for changing operating parameters is explained in another section (see Section 8.11, page 86).

**Procedure:**

- In the parameter group **Device > Update**, select the **Automatic Update** parameter and set to **Yes**.

## 8.22.2 Updating Firmware with Update File via the User Interface

### QUALIFIED PERSON

**Requirements:**

- An update file with the desired inverter firmware must be available. The update file is, for example, available for download on the product page of the inverter at [www.SMA-Solar.com](http://www.SMA-Solar.com). To download the update file, it is necessary to enter the serial number of the inverter.

**Procedure:**

1. Open the user interface (see Section 8.1, page 72).
2. Log into the user interface as an **Installer** (see Section 8.2, page 76).
3. Click on **[Edit parameters]**.
4. Select the menu **Device Configuration**.
5. In the product row, click on the gear icon and select **Update firmware**.
6. Select **[Browse]** and select the update file for the product.
7. Select **Update firmware**.
8. Follow the instructions in the dialog.
9. Open the user interface and check the events to see whether the firmware update has been completed successfully.

## 8.22.3 Updating Firmware with Update File via the USB Flash Drive

### QUALIFIED PERSON

**Requirement:**

- A USB flash drive with maximum 32 GB and file system FAT32 must be available.

**Procedure:**

1. Create an "UPDATE" folder on the USB stick.

2. Save the update file with the required firmware in the "UPDATE" folder on the USB flash drive. The update file is, for example, available for download on the product page of the inverter at [www.SMA-Solar.com](http://www.SMA-Solar.com). Ensure that only the update file to which the inverter is to be updated must be stored on the USB flash drive.

3.

**⚠ DANGER**

**Danger to life due to high voltages**

- Disconnect the inverter from all voltage sources and open the enclosure lid of the DC connection unit (see Section 9, page 96).

4. Insert the USB flash drive in the USB port on the communication assembly.
5. Commission the inverter (see Section 7.2, page 67).
  - During start-up phase of the inverter, the desired firmware is being installed.

6.

**⚠ DANGER**

**Danger to life due to high voltages**

- Disconnect the inverter from all voltage sources and open the enclosure lid of the DC connection unit (see Section 9, page 96).

7. Pull the USB flash drive out of the USB port.
8. Commission the inverter (see Section 7.2, page 67).
9. Open the user interface and check the events to see whether the firmware update has been completed successfully.
10. If the firmware update has not been successfully completed, perform the firmware update again.

## 8.22.4 Searching for and Installing New Firmware via the User Interface

**⚠ QUALIFIED PERSON**

**Requirement:**

- The inverter must be connected to the Internet.

**Procedure:**

1. Open the user interface (see Section 8.1, page 72).
2. Log into the user interface as an **Installer** (see Section 8.2, page 76).
3. Click on **[Edit parameters]**.
4. Go to **Device > Update**.
5. Select the parameter **Check for update and install it** and set it to **Execute**.
6. Click on **[Save all]**.
- The firmware is updated in the background.

## 9 Disconnecting the Inverter from Voltage Sources

### ⚠ QUALIFIED PERSON

Prior to performing any work on the product, always disconnect it from all voltage sources as described in this section. Always adhere to the prescribed sequence.

### ⚠ WARNING

#### Danger to life due to electric shock from destruction of the measuring device due to overvoltage

Overvoltage can damage a measuring device and result in voltage being present in the enclosure of the measuring device. Touching the live enclosure of the measuring device results in death or lethal injuries due to electric shock.

- Only use measuring devices with a DC input voltage range of 600 V or higher.

#### Procedure:

1. Disconnect the AC miniature circuit breaker and secure against reconnection.
2. Switch off the battery or the load-break switch of the battery (see documentation of the battery manufacturer).
3. Wait 5 minutes. This will ensure that the capacitors are discharged.
4. Unscrew all 6 screws of the enclosure lid of the Connection Unit and carefully remove the enclosure lid toward the front (TX25). When doing so, note that the LED assembly in the enclosure lid and the communication assembly in the inverter are connected via a ribbon cable.
5. Pull the ribbon cable connecting the LED assembly in the enclosure lid to the communication assembly out of the jack located on the communication assembly.

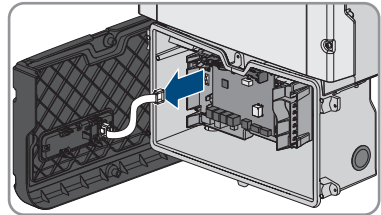

6. Ensure that no voltage is present on the **AC-out** terminal block between **L** and **N** using a suitable measuring device. To do this, stick the test probe in each rectangular opening of the terminal.
7. Ensure that no voltage is present on the **AC-out** terminal block between **L** and **PE** using a suitable measuring device. To do this, stick the test probe in each rectangular opening of the terminal.



## 10 Clean the product

### NOTICE

#### Damage to the product due to cleaning agents

The use of cleaning agents may cause damage to the product and its components.

- Clean the product and all its components only with a cloth moistened with clear water.

#### Procedure:

- Ensure that the product is free of dust, foliage and other dirt.

# 11 Troubleshooting

## 11.1 Forgotten Password

### **i** Password assignment for inverters that are registered in a communication product

The password for the user group **Installer** is also the system password for the system in the communication product. Changing the password of the user group **Installer** can lead to the inverter no longer being able to be reached by the communication product.

- In the communication product, assign the changed password of the user group **Installer** as the new system password (see the manual of the communication product).

If you have forgotten the password for the inverter, you can unlock the inverter with a Personal Unlocking Key (PUK). For each inverter, there is 1 PUK for each user group (**User** and **Installer**).  
Tipp: With PV systems that are registered in a communication product, you can also assign a new password for the user group **Installer** via the communication product. The password for the user group **Installer** is the same as the system password in the communication product.

#### **Procedure:**

1. Open the user interface (see Section 8.1, page 72).
2. Enter the PUK instead of the password into the field **Password**.
3. Select **Login**.
4. Call up the menu **Device parameters**.
5. Click on [**Edit parameters**].
6. In the parameter group **User Rights > Access Control** change the password of the desired user group.
7. Select [**Save all**] to save the changes.

## 11.2 Event Messages

Event number	Message, cause and corrective measures
101	<p><b>⚠ QUALIFIED PERSON</b></p> <p><b>Grid incident</b></p> <p>The grid voltage or grid impedance at the connection point of the inverter is too high. The inverter has disconnected from the utility grid.</p> <p><b>Corrective measures:</b></p> <ul style="list-style-type: none"> <li>• Ensure that the correct country data set has been configured.</li> <li>• Check whether the grid voltage at the connection point of the inverter is permanently in the permissible range.</li> </ul> <p>If the grid voltage is outside the permissible range due to local grid conditions, contact the grid operator. The grid operator must agree with an adjustment of the voltage at the feed-in point or with a change of the monitored operating limits.</p> <p>If the grid voltage is permanently within the permissible range and this message is still displayed, contact the Service.</p>
102	
103	
105	
202	<p><b>⚠ QUALIFIED PERSON</b></p> <p><b>Grid incident</b></p> <p>The utility grid has been disconnected, the AC cable is damaged or the grid voltage at the connection point of the inverter is too low. The inverter has disconnected from the utility grid.</p> <p><b>Corrective measures:</b></p> <ul style="list-style-type: none"> <li>• Ensure that the miniature circuit breaker is switched on.</li> <li>• Ensure that the AC cable is not damaged and that it is connected correctly.</li> <li>• Ensure that the country data set has been configured correctly.</li> <li>• Check whether the grid voltage at the connection point of the inverter is permanently in the permissible range.</li> </ul> <p>If the grid voltage is outside the permissible range due to local grid conditions, contact the grid operator. The grid operator must agree with an adjustment of the voltage at the feed-in point or with a change of the monitored operating limits.</p> <p>If the grid voltage is permanently within the permissible range and this message is still displayed, contact the Service.</p>
203	
205	
206	

Event number	Message, cause and corrective measures
301	<p data-bbox="311 188 596 220"><b>⚠ QUALIFIED PERSON</b></p> <p data-bbox="288 236 426 260"><b>Grid incident</b></p> <p data-bbox="288 272 994 384">The ten-minute average value of the grid voltage is no longer within the permissible range. The grid voltage or grid impedance at the connection point is too high. The inverter disconnects from the utility grid to maintain power quality.</p> <p data-bbox="288 395 508 419"><b>Corrective measures:</b></p> <ul data-bbox="311 432 994 667" style="list-style-type: none"> <li data-bbox="311 432 994 603">• During the feed-in operation, check whether the grid voltage at the connection point of the inverter is permanently in the permissible range. If the grid voltage is outside the permissible range due to local grid conditions, contact the grid operator. The grid operator must agree with an adjustment of the voltage at the feed-in point or with a change of the monitored operating limits. If the grid voltage is permanently within the permissible range and this message is still displayed, contact the Service.</li> </ul>
302	<p data-bbox="288 683 596 707"><b>Active power limit AC voltage</b></p> <p data-bbox="288 719 975 767">The inverter has reduced its power due to a too-high grid voltage to ensure grid stability.</p> <p data-bbox="288 778 508 802"><b>Corrective measures:</b></p> <ul data-bbox="311 815 1005 954" style="list-style-type: none"> <li data-bbox="311 815 1005 954">• If possible, check the grid voltage and observe how often fluctuations occur. If fluctuations occur frequently and this message is displayed often, contact the grid operator and request approval to change the operating parameters of the inverter. If the grid operator gives his approval, discuss any changes to the operating parameters with the Service.</li> </ul>
401 404	<p data-bbox="311 970 596 1002"><b>⚠ QUALIFIED PERSON</b></p> <p data-bbox="288 1018 426 1042"><b>Grid incident</b></p> <p data-bbox="288 1054 1005 1110">The inverter has disconnected from the utility grid. A stand-alone grid or a very large change in the grid frequency was detected.</p> <p data-bbox="288 1121 508 1145"><b>Corrective measures:</b></p> <ul data-bbox="311 1158 1005 1182" style="list-style-type: none"> <li data-bbox="311 1158 1005 1182">• Check the grid connection for significant short-term frequency fluctuations.</li> </ul>

Event number	Message, cause and corrective measures
501	<p data-bbox="308 183 593 215"><b>⚠ QUALIFIED PERSON</b></p> <p data-bbox="285 231 425 263"><b>Grid incident</b></p> <p data-bbox="285 271 991 327">The power frequency is not within the permissible range. The inverter has disconnected from the utility grid.</p> <p data-bbox="285 335 509 359"><b>Corrective measures:</b></p> <ul data-bbox="308 367 996 574" style="list-style-type: none"><li data-bbox="308 367 996 422">• If possible, check the power frequency and observe how often fluctuations occur. If fluctuations occur frequently and this message is displayed often, contact the grid operator and request approval to change the operating parameters of the inverter. If the grid operator gives his approval, discuss any changes to the operating parameters with the Service.</li></ul>
507	<p data-bbox="285 590 621 622"><b>Active power limit AC frequency</b></p> <p data-bbox="285 630 985 686">The inverter has reduced its power due to a too-high power frequency to ensure grid stability.</p> <p data-bbox="285 694 509 718"><b>Corrective measures:</b></p> <ul data-bbox="308 726 1002 893" style="list-style-type: none"><li data-bbox="308 726 1002 893">• If possible, check the power frequency and observe how often fluctuations occur. If fluctuations occur frequently and this message is displayed often, contact the grid operator and request approval to change the operating parameters of the inverter. If the grid operator gives his approval, discuss any changes to the operating parameters with the Service.</li></ul>
601	<p data-bbox="308 909 593 941"><b>⚠ QUALIFIED PERSON</b></p> <p data-bbox="285 957 425 989"><b>Grid incident</b></p> <p data-bbox="285 997 980 1053">The inverter has detected an excessively high proportion of direct current in the grid current.</p> <p data-bbox="285 1061 509 1085"><b>Corrective measures:</b></p> <ul data-bbox="308 1093 968 1181" style="list-style-type: none"><li data-bbox="308 1093 968 1125">• Check the grid connection for direct current.</li><li data-bbox="308 1125 968 1181">• If this message is displayed frequently, contact the grid operator and check whether the monitoring threshold on the inverter can be raised.</li></ul>

Event number	Message, cause and corrective measures
701	<p data-bbox="311 188 596 220"><b>⚠ QUALIFIED PERSON</b></p> <p data-bbox="288 236 744 263"><b>Frequency not permitted &gt; Check parameter</b></p> <p data-bbox="288 272 992 327">The power frequency is not within the permissible range. The inverter has disconnected from the utility grid.</p> <p data-bbox="288 336 508 360"><b>Corrective measures:</b></p> <ul data-bbox="311 370 995 579" style="list-style-type: none"> <li data-bbox="311 370 906 424">• If possible, check the power frequency and observe how often fluctuations occur.</li> <li data-bbox="311 434 995 517">If fluctuations occur frequently and this message is displayed often, contact the grid operator and request approval to change the operating parameters of the inverter.</li> <li data-bbox="311 526 938 579">If the grid operator gives his approval, discuss any changes to the operating parameters with the Service.</li> </ul>
901	<p data-bbox="311 598 596 630"><b>⚠ QUALIFIED PERSON</b></p> <p data-bbox="288 646 805 673"><b>Grounding connection missing &gt; Check connection</b></p> <p data-bbox="288 683 766 707">The grounding conductor is not correctly connected.</p> <p data-bbox="288 716 508 740"><b>Corrective measures:</b></p> <ul data-bbox="311 750 878 774" style="list-style-type: none"> <li data-bbox="311 750 878 774">• Ensure that the grounding conductor is correctly connected.</li> </ul>
1001	<p data-bbox="311 794 596 826"><b>⚠ QUALIFIED PERSON</b></p> <p data-bbox="288 842 649 869"><b>L / N swapped &gt; Check connection</b></p> <p data-bbox="288 879 649 903">The connection of L and N is swapped.</p> <p data-bbox="288 912 508 936"><b>Corrective measures:</b></p> <ul data-bbox="311 946 973 970" style="list-style-type: none"> <li data-bbox="311 946 973 970">• Ensure that L and N are correctly connected (see installation manual).</li> </ul>
1101	<p data-bbox="311 991 596 1023"><b>⚠ QUALIFIED PERSON</b></p> <p data-bbox="288 1038 562 1066"><b>2nd phase connected to N</b></p> <p data-bbox="288 1075 687 1099">A second line conductor is connected to N.</p> <p data-bbox="288 1109 508 1133"><b>Corrective measures:</b></p> <ul data-bbox="311 1142 893 1166" style="list-style-type: none"> <li data-bbox="311 1142 893 1166">• Connect the neutral conductor to N (see installation manual).</li> </ul>
1302	<p data-bbox="311 1187 596 1219"><b>⚠ QUALIFIED PERSON</b></p> <p data-bbox="288 1235 743 1262"><b>Phase(s) or neutral conductor not connected</b></p> <p data-bbox="288 1272 490 1295">L or N not connected.</p> <p data-bbox="288 1305 508 1329"><b>Corrective measures:</b></p> <ul data-bbox="311 1339 1006 1458" style="list-style-type: none"> <li data-bbox="311 1339 888 1362">• Ensure that L and N are connected (see installation manual).</li> <li data-bbox="311 1372 1006 1426">• Ensure that the AC conductors are not damaged and correctly connected (see installation manual).</li> <li data-bbox="311 1436 835 1458">• Ensure that the miniature circuit breaker is switched on.</li> </ul>

Event number	Message, cause and corrective measures
1501	<p data-bbox="314 188 594 220"><b>⚠ QUALIFIED PERSON</b></p> <p data-bbox="292 236 527 261"><b>Reconnection fault grid</b></p> <p data-bbox="292 272 992 355">The changed country data set or the value of a parameter you have set does not correspond to the local requirements. The inverter cannot connect to the utility grid.</p> <p data-bbox="292 367 507 389"><b>Corrective measures:</b></p> <ul data-bbox="311 400 1006 453" style="list-style-type: none"> <li>• Ensure that the country data set has been configured correctly. To do this, select the parameter <b>Set country standard</b> and check the value.</li> </ul>
3301 3302 3303	<p data-bbox="314 472 594 504"><b>⚠ QUALIFIED PERSON</b></p> <p data-bbox="292 520 490 545"><b>Unstable operation</b></p> <p data-bbox="292 557 1001 609">There is not enough power at the DC input of the inverter for stable operation. The inverter cannot connect to the utility grid.</p> <p data-bbox="292 620 507 643"><b>Corrective measures:</b></p> <ul data-bbox="311 654 852 679" style="list-style-type: none"> <li>• Ensure that the correct battery type has been configured.</li> </ul>
3401 3402 3407	<p data-bbox="314 699 594 730"><b>⚠ QUALIFIED PERSON</b></p> <p data-bbox="292 746 684 772"><b>DC overvoltage &gt; Disconnect PV array</b></p> <p data-bbox="292 783 820 809">Overvoltage at the DC input. This can destroy the inverter.</p> <p data-bbox="292 820 507 842"><b>Corrective measures:</b></p> <ul data-bbox="311 853 981 1066" style="list-style-type: none"> <li>• <b>Immediately</b> disconnect the inverter from all voltage sources.</li> <li>• Check whether the DC voltage is below the maximum input voltage of the inverter. If the DC voltage is below the maximum DC voltage of the inverter, reconnect the DC connectors to the inverter.</li> <li>• If the DC voltage is above the maximum DC voltage of the inverter, ensure that the correct battery has been selected.</li> <li>• If this message is repeated frequently, contact the Service.</li> </ul>
3501	<p data-bbox="314 1086 594 1118"><b>⚠ QUALIFIED PERSON</b></p> <p data-bbox="292 1134 658 1160"><b>Insulation failure &gt; Check generator</b></p> <p data-bbox="292 1171 801 1197">The inverter has detected a ground fault on the DC side.</p> <p data-bbox="292 1208 507 1230"><b>Corrective measures:</b></p> <ul data-bbox="311 1241 810 1267" style="list-style-type: none"> <li>• Check the battery and DC cabling for ground faults.</li> </ul>

Event number	Message, cause and corrective measures
3601	<p data-bbox="311 185 596 220"><b>⚠ QUALIFIED PERSON</b></p> <p data-bbox="288 236 692 263"><b>High leakage current &gt; Check PV array</b></p> <p data-bbox="288 272 949 325">The leakage current of the inverter and the battery is too high. There is a ground fault, a residual current or a malfunction.</p> <p data-bbox="288 335 986 416">The inverter interrupts parallel grid operation immediately after exceeding a threshold. When the fault is eliminated, the inverter automatically reconnects to the utility grid.</p> <p data-bbox="288 426 508 453"><b>Corrective measures:</b></p> <ul data-bbox="311 461 810 488" style="list-style-type: none"> <li>• Check the battery and DC cabling for ground faults.</li> </ul>
3701	<p data-bbox="311 499 596 534"><b>⚠ QUALIFIED PERSON</b></p> <p data-bbox="288 550 732 577"><b>Residual current too high &gt; Check PV array</b></p> <p data-bbox="288 587 986 639">The inverter detected a residual current due to brief grounding of the battery or the DC cabling.</p> <p data-bbox="288 649 508 676"><b>Corrective measures:</b></p> <ul data-bbox="311 684 810 711" style="list-style-type: none"> <li>• Check the battery and DC cabling for ground faults.</li> </ul>
3801 3802 3805	<p data-bbox="311 727 596 762"><b>⚠ QUALIFIED PERSON</b></p> <p data-bbox="288 778 631 805"><b>DC overcurrent &gt; Check PV array</b></p> <p data-bbox="288 815 981 842">Overcurrent at the DC input. The inverter briefly interrupts feed-in operation.</p> <p data-bbox="288 852 508 879"><b>Corrective measures:</b></p> <ul data-bbox="311 887 986 940" style="list-style-type: none"> <li>• If this message is displayed frequently, ensure that the battery has been correctly connected and that the correct battery has been selected.</li> </ul>
3901	<p data-bbox="311 956 596 991"><b>⚠ QUALIFIED PERSON</b></p> <p data-bbox="288 1007 479 1034"><b>DC power too low</b></p> <p data-bbox="288 1043 508 1070"><b>Corrective measures:</b></p> <ul data-bbox="311 1078 997 1195" style="list-style-type: none"> <li>• Check whether a new firmware version is available for the inverter and the battery. If a newer version is available, perform the firmware update.</li> <li>• If no new firmware version is available, check for other events. If there are other events, carry out the corrective measures for the other events.</li> </ul>



Event number	Message, cause and corrective measures
3902	<p data-bbox="308 183 593 215"><b>⚠ QUALIFIED PERSON</b></p> <p data-bbox="285 231 565 263"><b>Generator voltage too low</b></p> <p data-bbox="285 271 509 295"><b>Corrective measures:</b></p> <ul data-bbox="308 303 1002 454" style="list-style-type: none"> <li data-bbox="308 303 1002 359">• Check whether a new firmware version is available for the inverter and the battery. If a newer version is available, perform the firmware update.</li> <li data-bbox="308 367 1002 454">• If a new firmware version is not available, check whether there are other event messages. If there are further event messages, perform the corrective measures of the further messages.</li> </ul>
6001	<p data-bbox="308 470 593 502"><b>⚠ QUALIFIED PERSON</b></p> <p data-bbox="285 518 509 550"><b>System data restored</b></p> <p data-bbox="285 558 509 582"><b>Corrective measures:</b></p> <ul data-bbox="308 590 834 614" style="list-style-type: none"> <li data-bbox="308 590 834 614">• If this message is displayed again, contact the Service.</li> </ul>
6002	<p data-bbox="308 630 593 662"><b>⚠ QUALIFIED PERSON</b></p> <p data-bbox="285 678 520 710"><b>System data defective</b></p> <p data-bbox="285 718 509 742"><b>Corrective measures:</b></p> <ul data-bbox="308 750 834 774" style="list-style-type: none"> <li data-bbox="308 750 834 774">• If this message is displayed again, contact the Service.</li> </ul>
6003	<p data-bbox="308 790 593 821"><b>⚠ QUALIFIED PERSON</b></p> <p data-bbox="285 837 621 869"><b>System data access not possible</b></p> <p data-bbox="285 877 509 901"><b>Corrective measures:</b></p> <ul data-bbox="308 909 834 933" style="list-style-type: none"> <li data-bbox="308 909 834 933">• If this message is displayed again, contact the Service.</li> </ul>
6004	<p data-bbox="308 949 593 981"><b>⚠ QUALIFIED PERSON</b></p> <p data-bbox="285 997 532 1029"><b>Main memory defective</b></p> <p data-bbox="285 1037 509 1061"><b>Corrective measures:</b></p> <ul data-bbox="308 1069 834 1093" style="list-style-type: none"> <li data-bbox="308 1069 834 1093">• If this message is displayed again, contact the Service.</li> </ul>
6005	<p data-bbox="308 1109 593 1141"><b>⚠ QUALIFIED PERSON</b></p> <p data-bbox="285 1157 532 1189"><b>Code memory defective</b></p> <p data-bbox="285 1197 509 1220"><b>Corrective measures:</b></p> <ul data-bbox="308 1228 834 1252" style="list-style-type: none"> <li data-bbox="308 1228 834 1252">• If this message is displayed again, contact the Service.</li> </ul>
6006	<p data-bbox="308 1268 593 1300"><b>⚠ QUALIFIED PERSON</b></p> <p data-bbox="285 1316 453 1348"><b>CPU self-test HP</b></p> <p data-bbox="285 1356 509 1380"><b>Corrective measures:</b></p> <ul data-bbox="308 1388 834 1412" style="list-style-type: none"> <li data-bbox="308 1388 834 1412">• If this message is displayed again, contact the Service.</li> </ul>

Event number	Message, cause and corrective measures
6009	<p><b>Data inconsistency</b></p> <p><b>Corrective measures:</b></p> <ul style="list-style-type: none"> <li>• If this message is displayed again, contact the Service.</li> </ul>
6101	<p><b>⚠ QUALIFIED PERSON</b></p> <p><b>24 h watchdog test</b></p> <p><b>Corrective measures:</b></p> <ul style="list-style-type: none"> <li>• If this message is displayed again, contact the Service.</li> </ul>
6105	<p><b>⚠ QUALIFIED PERSON</b></p> <p><b>Execution (Operation)</b></p> <p>Processor defective.</p> <p><b>Corrective measures:</b></p> <ul style="list-style-type: none"> <li>• Contact the Service.</li> </ul>
6107	<p><b>⚠ QUALIFIED PERSON</b></p> <p><b>Execution (State machine)</b></p> <p>Processor defective.</p> <p><b>Corrective measures:</b></p> <ul style="list-style-type: none"> <li>• Contact the Service.</li> </ul>
6109	<p><b>⚠ QUALIFIED PERSON</b></p> <p><b>General BSP fault</b></p> <p>Processor defective.</p> <p><b>Corrective measures:</b></p> <ul style="list-style-type: none"> <li>• Contact the Service.</li> </ul>
6111	<p><b>⚠ QUALIFIED PERSON</b></p> <p><b>Execution (SharedMemory)</b></p> <p>Processor defective.</p> <p><b>Corrective measures:</b></p> <ul style="list-style-type: none"> <li>• Contact the Service.</li> </ul>
6112	<p><b>⚠ QUALIFIED PERSON</b></p> <p><b>Execution (Watchdog)</b></p> <p>Processor defective.</p> <p><b>Corrective measures:</b></p> <ul style="list-style-type: none"> <li>• Contact the Service.</li> </ul>

Event number	Message, cause and corrective measures
6121	<p data-bbox="291 183 593 215"><b>⚠ QUALIFIED PERSON</b></p> <p data-bbox="291 231 448 263"><b>Watchdog DSP</b></p> <p data-bbox="291 271 470 295">Processor defective.</p> <p data-bbox="291 303 504 327"><b>Corrective measures:</b></p> <ul data-bbox="308 335 515 359" style="list-style-type: none"><li data-bbox="308 335 515 359">• Contact the Service.</li></ul>
6155	<p data-bbox="291 383 593 414"><b>⚠ QUALIFIED PERSON</b></p> <p data-bbox="291 430 470 454"><b>Version test failed</b></p> <p data-bbox="291 462 470 486">Processor defective.</p> <p data-bbox="291 494 504 518"><b>Corrective measures:</b></p> <ul data-bbox="308 526 515 550" style="list-style-type: none"><li data-bbox="308 526 515 550">• Contact the Service.</li></ul>
6202	<p data-bbox="291 574 593 606"><b>⚠ QUALIFIED PERSON</b></p> <p data-bbox="291 622 470 646"><b>DI converter fault</b></p> <p data-bbox="291 654 470 678">Measurement error.</p> <p data-bbox="291 686 504 710"><b>Corrective measures:</b></p> <ul data-bbox="308 718 515 742" style="list-style-type: none"><li data-bbox="308 718 515 742">• Contact the Service.</li></ul>
6301	<p data-bbox="291 766 593 798"><b>⚠ QUALIFIED PERSON</b></p> <p data-bbox="291 813 548 837"><b>Offset grid current sensor</b></p> <p data-bbox="291 845 470 869">Measurement error.</p> <p data-bbox="291 877 504 901"><b>Corrective measures:</b></p> <ul data-bbox="308 909 515 933" style="list-style-type: none"><li data-bbox="308 909 515 933">• Contact the Service.</li></ul>
6304	<p data-bbox="291 957 593 989"><b>⚠ QUALIFIED PERSON</b></p> <p data-bbox="291 1005 627 1029"><b>Grid voltage measurement offset</b></p> <p data-bbox="291 1037 470 1061">Measurement error.</p> <p data-bbox="291 1069 504 1093"><b>Corrective measures:</b></p> <ul data-bbox="308 1101 515 1125" style="list-style-type: none"><li data-bbox="308 1101 515 1125">• Contact the Service.</li></ul>
6305	<p data-bbox="291 1149 593 1181"><b>⚠ QUALIFIED PERSON</b></p> <p data-bbox="291 1197 660 1220"><b>Deviation grid voltage measurement</b></p> <p data-bbox="291 1228 470 1252">Measurement error.</p> <p data-bbox="291 1260 504 1284"><b>Corrective measures:</b></p> <ul data-bbox="308 1292 515 1316" style="list-style-type: none"><li data-bbox="308 1292 515 1316">• Contact the Service.</li></ul>

Event number	Message, cause and corrective measures
6306	<p data-bbox="311 188 596 220"><b>⚠ QUALIFIED PERSON</b></p> <p data-bbox="288 236 655 263"><b>DC voltage measurement deviation</b></p> <p data-bbox="288 272 476 296">Measurement error.</p> <p data-bbox="288 306 509 330"><b>Corrective measures:</b></p> <ul data-bbox="311 339 520 363" style="list-style-type: none"> <li>• Contact the Service.</li> </ul>
6401	<p data-bbox="311 387 596 419"><b>⚠ QUALIFIED PERSON</b></p> <p data-bbox="288 435 655 462"><b>Sensor system insulation resistance</b></p> <p data-bbox="288 472 476 496">Measurement error.</p> <p data-bbox="288 505 509 529"><b>Corrective measures:</b></p> <ul data-bbox="311 539 520 563" style="list-style-type: none"> <li>• Contact the Service.</li> </ul>
6403	<p data-bbox="311 579 596 611"><b>⚠ QUALIFIED PERSON</b></p> <p data-bbox="288 627 532 654"><b>Overvoltage grid (HW)</b></p> <p data-bbox="288 663 509 687"><b>Corrective measures:</b></p> <ul data-bbox="311 697 991 877" style="list-style-type: none"> <li>• If there are several inverters in the system, check whether they also display this event message. If all inverters display this event message, a grid error is present.</li> <li>• If there is only one inverter, check for a grid error.</li> <li>• If there is no grid error and this message is displayed again, contact the Service.</li> </ul>
6404	<p data-bbox="311 898 596 930"><b>⚠ QUALIFIED PERSON</b></p> <p data-bbox="288 946 532 973"><b>Overvoltage grid (HW)</b></p> <p data-bbox="288 983 509 1007"><b>Corrective measures:</b></p> <ul data-bbox="311 1016 1002 1101" style="list-style-type: none"> <li>• Check whether there is a new firmware version available for the inverter. If a newer version is available, perform the firmware update.</li> <li>• If no new firmware version is available, contact Service.</li> </ul>
6405	<p data-bbox="311 1121 596 1153"><b>⚠ QUALIFIED PERSON</b></p> <p data-bbox="288 1169 688 1197"><b>Overvoltage intermediate circuit (HW)</b></p> <p data-bbox="288 1206 509 1230"><b>Corrective measures:</b></p> <ul data-bbox="311 1240 1002 1324" style="list-style-type: none"> <li>• Check whether there is a new firmware version available for the inverter. If a newer version is available, perform the firmware update.</li> <li>• If no new firmware version is available, contact Service.</li> </ul>

Event number	Message, cause and corrective measures
6406	<p data-bbox="311 188 595 220"><b>⚠ QUALIFIED PERSON</b></p> <p data-bbox="288 236 557 263"><b>Overcurrent input A (HW)</b></p> <p data-bbox="288 272 508 296"><b>Corrective measures:</b></p> <ul data-bbox="311 308 999 526" style="list-style-type: none"> <li>• Check whether a new firmware version is available for the inverter and the battery. If a newer version is available, perform the firmware update.</li> <li>• If no new firmware version is available, check for other events. If there are other events, carry out the corrective measures for the other events.</li> <li>• Check the battery for any faults.</li> <li>• Ensure that there is not a short circuit present at the DC connection.</li> <li>• If this message is displayed again, contact the Service.</li> </ul>
6407	<p data-bbox="311 547 595 579"><b>⚠ QUALIFIED PERSON</b></p> <p data-bbox="288 595 557 622"><b>Overcurrent input B (HW)</b></p> <p data-bbox="288 632 508 655"><b>Corrective measures:</b></p> <ul data-bbox="311 667 999 885" style="list-style-type: none"> <li>• Check whether a new firmware version is available for the inverter and the battery. If a newer version is available, perform the firmware update.</li> <li>• If no new firmware version is available, check for other events. If there are other events, carry out the corrective measures for the other events.</li> <li>• Check the battery for any faults.</li> <li>• Ensure that there is not a short circuit present at the DC connection.</li> <li>• If this message is displayed again, contact the Service.</li> </ul>
6408	<p data-bbox="311 903 595 935"><b>⚠ QUALIFIED PERSON</b></p> <p data-bbox="288 951 454 978"><b>UCE monitoring</b></p> <p data-bbox="288 987 508 1011"><b>Corrective measures:</b></p> <ul data-bbox="311 1023 833 1050" style="list-style-type: none"> <li>• If this message is displayed again, contact the Service.</li> </ul>
6409	<p data-bbox="311 1067 595 1099"><b>⚠ QUALIFIED PERSON</b></p> <p data-bbox="288 1115 483 1142"><b>Bridge short-circuit</b></p> <p data-bbox="288 1152 508 1176"><b>Corrective measures:</b></p> <ul data-bbox="311 1187 833 1214" style="list-style-type: none"> <li>• If this message is displayed again, contact the Service.</li> </ul>
6410	<p data-bbox="311 1232 595 1264"><b>⚠ QUALIFIED PERSON</b></p> <p data-bbox="288 1279 669 1307"><b>On-board supply system disturbance</b></p> <p data-bbox="288 1316 508 1340"><b>Corrective measures:</b></p> <ul data-bbox="311 1351 833 1378" style="list-style-type: none"> <li>• If this message is displayed again, contact the Service.</li> </ul>

Event number	Message, cause and corrective measures
6411	<p><b>⚠ QUALIFIED PERSON</b></p> <p><b>Power unit</b></p> <p><b>Corrective measures:</b></p> <ul style="list-style-type: none"> <li>• If this message is displayed again, contact the Service.</li> </ul>
6412	<p><b>⚠ QUALIFIED PERSON</b></p> <p><b>Overcurrent input C (HW)</b></p> <p><b>Corrective measures:</b></p> <ul style="list-style-type: none"> <li>• Check whether a new firmware version is available for the inverter and the battery. If a newer version is available, perform the firmware update.</li> <li>• If no new firmware version is available, check for other events. If there are other events, carry out the corrective measures for the other events.</li> <li>• Check the battery for any faults.</li> <li>• Ensure that there is not a short circuit present at the DC connection.</li> <li>• If this message is displayed again, contact the Service.</li> </ul>
6415	<p><b>⚠ QUALIFIED PERSON</b></p> <p><b>Reference voltage test</b></p> <p><b>Corrective measures:</b></p> <ul style="list-style-type: none"> <li>• If this message is displayed again, contact the Service.</li> </ul>
6416	<p><b>⚠ QUALIFIED PERSON</b></p> <p><b>External watchdog (enable)</b></p> <p><b>Corrective measures:</b></p> <ul style="list-style-type: none"> <li>• If this message is displayed again, contact the Service.</li> </ul>
6462	<p><b>⚠ QUALIFIED PERSON</b></p> <p><b>Overcurrent battery (HW)</b></p> <p><b>Corrective measures:</b></p> <ul style="list-style-type: none"> <li>• Check whether a new firmware version is available for the inverter and the battery. If a newer version is available, perform the firmware update.</li> <li>• If no new firmware version is available and this message is displayed again, contact the Service.</li> </ul>
6499	<p><b>⚠ QUALIFIED PERSON</b></p> <p><b>Precharging overload protection triggered</b></p> <p><b>Corrective measures:</b></p> <ul style="list-style-type: none"> <li>• If this message is displayed again, contact the Service.</li> </ul>

Event number	Message, cause and corrective measures
6501	<p data-bbox="311 183 593 215"><b>⚠ QUALIFIED PERSON</b></p> <p data-bbox="288 231 554 263"><b>Overtemperature interior</b></p> <p data-bbox="288 271 509 295"><b>Corrective measures:</b></p> <ul data-bbox="311 303 963 454" style="list-style-type: none"> <li data-bbox="311 303 700 327">• Check whether the airflow is free of dirt.</li> <li data-bbox="311 335 952 391">• Ensure that the ambient temperature does not exceed the maximum permissible temperatures.</li> <li data-bbox="311 399 963 454">• If the maximum permissible temperatures are met at all times and this message is displayed again, contact the Service.</li> </ul>
6502	<p data-bbox="311 470 593 502"><b>⚠ QUALIFIED PERSON</b></p> <p data-bbox="288 518 588 550"><b>Overtemperature power unit</b></p> <p data-bbox="288 558 509 582"><b>Corrective measures:</b></p> <ul data-bbox="311 590 963 742" style="list-style-type: none"> <li data-bbox="311 590 700 614">• Check whether the airflow is free of dirt.</li> <li data-bbox="311 622 952 678">• Ensure that the ambient temperature does not exceed the maximum permissible temperatures.</li> <li data-bbox="311 686 963 742">• If the maximum permissible temperatures are met at all times and this message is displayed again, contact the Service.</li> </ul>
6509	<p data-bbox="311 758 593 790"><b>⚠ QUALIFIED PERSON</b></p> <p data-bbox="288 805 638 837"><b>Overtemperature boost converter</b></p> <p data-bbox="288 845 509 869"><b>Corrective measures:</b></p> <ul data-bbox="311 877 963 1029" style="list-style-type: none"> <li data-bbox="311 877 700 901">• Check whether the airflow is free of dirt.</li> <li data-bbox="311 909 952 965">• Ensure that the ambient temperature does not exceed the maximum permissible temperatures.</li> <li data-bbox="311 973 963 1029">• If the maximum permissible temperatures are met at all times and this message is displayed again, contact the Service.</li> </ul>
6512	<p data-bbox="288 1045 756 1077"><b>Minimum operating temperature not reached</b></p> <p data-bbox="288 1085 952 1133">The inverter will only recommence grid feed-in once the temperature has reached at least <math>-25^{\circ}\text{C}</math>.</p>
6603	<p data-bbox="311 1149 593 1181"><b>⚠ QUALIFIED PERSON</b></p> <p data-bbox="288 1197 520 1228"><b>Overcurrent grid (SW)</b></p> <p data-bbox="288 1236 509 1260"><b>Corrective measures:</b></p> <ul data-bbox="311 1268 991 1452" style="list-style-type: none"> <li data-bbox="311 1268 991 1356">• If there are several inverters in the system, check whether they also display this event message. If all inverters display this event message, a grid error is present.</li> <li data-bbox="311 1364 789 1388">• If there is only one inverter, check for a grid error.</li> <li data-bbox="311 1396 991 1452">• If there is no grid error and this message is displayed again, contact the Service.</li> </ul>

Event number	Message, cause and corrective measures
6604	<p data-bbox="311 183 582 215"><b>⚠ QUALIFIED PERSON</b></p> <p data-bbox="288 231 677 263"><b>Overvoltage intermediate circuit (SW)</b></p> <p data-bbox="288 271 504 295"><b>Corrective measures:</b></p> <ul data-bbox="311 303 996 454" style="list-style-type: none"> <li data-bbox="311 303 996 359">• Check whether there is a new firmware version available for the inverter. If a newer version is available, perform the firmware update.</li> <li data-bbox="311 367 840 391">• If no new firmware version is available, contact Service.</li> <li data-bbox="311 399 996 454">• Check whether there was a DC overvoltage. If DC overvoltage was present, contact the Service.</li> </ul>
6607	<p data-bbox="311 470 582 502"><b>⚠ QUALIFIED PERSON</b></p> <p data-bbox="288 518 649 550"><b>Charge battery overcurr. (SW limit)</b></p> <p data-bbox="288 558 504 582"><b>Corrective measures:</b></p> <ul data-bbox="311 590 996 710" style="list-style-type: none"> <li data-bbox="311 590 996 646">• Check whether a new firmware version is available for the inverter and the battery. If a newer version is available, perform the firmware update.</li> <li data-bbox="311 654 996 710">• If no new firmware version is available and this message is displayed again, contact the Service.</li> </ul>
6608	<p data-bbox="311 726 582 758"><b>⚠ QUALIFIED PERSON</b></p> <p data-bbox="288 774 588 805"><b>Disch. battery overcurr. (SW)</b></p> <p data-bbox="288 813 504 837"><b>Corrective measures:</b></p> <ul data-bbox="311 845 996 965" style="list-style-type: none"> <li data-bbox="311 845 996 901">• Check whether a new firmware version is available for the inverter and the battery. If a newer version is available, perform the firmware update.</li> <li data-bbox="311 909 996 965">• If no new firmware version is available and this message is displayed again, contact the Service.</li> </ul>
6609	<p data-bbox="311 981 582 1013"><b>⚠ QUALIFIED PERSON</b></p> <p data-bbox="288 1029 610 1061"><b>Battery undervoltage (SW limit)</b></p> <p data-bbox="288 1069 504 1093"><b>Corrective measures:</b></p> <ul data-bbox="311 1101 996 1220" style="list-style-type: none"> <li data-bbox="311 1101 996 1157">• Check whether a new firmware version is available for the inverter and the battery. If a newer version is available, perform the firmware update.</li> <li data-bbox="311 1165 996 1220">• If no new firmware version is available and this message is displayed again, contact the Service.</li> </ul>



Event number	Message, cause and corrective measures
6610	<p data-bbox="308 183 593 215"><b>⚠ QUALIFIED PERSON</b></p> <p data-bbox="285 231 604 263"><b>Battery overvoltage (SW limit)</b></p> <p data-bbox="285 271 509 295"><b>Corrective measures:</b></p> <ul data-bbox="308 303 1002 422" style="list-style-type: none"> <li data-bbox="308 303 1002 359">• Check whether a new firmware version is available for the inverter and the battery. If a newer version is available, perform the firmware update.</li> <li data-bbox="308 367 1002 422">• If no new firmware version is available and this message is displayed again, contact the Service.</li> </ul>
6701	<p data-bbox="308 438 593 470"><b>⚠ QUALIFIED PERSON</b></p> <p data-bbox="285 486 487 518"><b>Program Sequence</b></p> <p data-bbox="285 526 509 550"><b>Corrective measures:</b></p> <ul data-bbox="308 558 1002 678" style="list-style-type: none"> <li data-bbox="308 558 1002 614">• Check whether a new firmware version is available for the inverter and the battery. If a newer version is available, perform the firmware update.</li> <li data-bbox="308 622 1002 678">• If no new firmware version is available and this message is displayed again, contact the Service.</li> </ul>
6702	<p data-bbox="308 694 593 726"><b>⚠ QUALIFIED PERSON</b></p> <p data-bbox="285 742 453 774"><b>No system data</b></p> <p data-bbox="285 782 509 805"><b>Corrective measures:</b></p> <ul data-bbox="308 813 1002 933" style="list-style-type: none"> <li data-bbox="308 813 1002 869">• Check whether a new firmware version is available for the inverter and the battery. If a newer version is available, perform the firmware update.</li> <li data-bbox="308 877 1002 933">• If no new firmware version is available and this message is displayed again, contact the Service.</li> </ul>
6801	<p data-bbox="308 949 593 981"><b>⚠ QUALIFIED PERSON</b></p> <p data-bbox="285 997 565 1029"><b>Offset DC current sensor A</b></p> <p data-bbox="285 1037 509 1061"><b>Corrective measures:</b></p> <ul data-bbox="308 1069 834 1093" style="list-style-type: none"> <li data-bbox="308 1069 834 1093">• If this message is displayed again, contact the Service.</li> </ul>
6802	<p data-bbox="308 1109 593 1141"><b>⚠ QUALIFIED PERSON</b></p> <p data-bbox="285 1157 610 1189"><b>DC converter string A defective</b></p> <p data-bbox="285 1197 509 1220"><b>Corrective measures:</b></p> <ul data-bbox="308 1228 834 1252" style="list-style-type: none"> <li data-bbox="308 1228 834 1252">• If this message is displayed again, contact the Service.</li> </ul>
6901	<p data-bbox="308 1268 593 1300"><b>⚠ QUALIFIED PERSON</b></p> <p data-bbox="285 1316 565 1348"><b>Offset DC current sensor B</b></p> <p data-bbox="285 1356 509 1380"><b>Corrective measures:</b></p> <ul data-bbox="308 1388 834 1412" style="list-style-type: none"> <li data-bbox="308 1388 834 1412">• If this message is displayed again, contact the Service.</li> </ul>

Event number	Message, cause and corrective measures
6902	<p><b>⚠ QUALIFIED PERSON</b></p> <p><b>DC converter string B defective</b></p> <p><b>Corrective measures:</b></p> <ul style="list-style-type: none"> <li>• If this message is displayed again, contact the Service.</li> </ul>
7001	<p><b>⚠ QUALIFIED PERSON</b></p> <p><b>Fault sensor interior temperature</b></p> <p>Measurement error.</p> <p><b>Corrective measures:</b></p> <ul style="list-style-type: none"> <li>• Contact the Service.</li> </ul>
7002	<p><b>⚠ QUALIFIED PERSON</b></p> <p><b>Fault sensor power unit temperature</b></p> <p>Measurement error.</p> <p><b>Corrective measures:</b></p> <ul style="list-style-type: none"> <li>• Contact the Service.</li> </ul>
7106	<p><b>Update file defective</b></p> <p>The update file is defective. The update failed. The inverter continues to feed in.</p>
7110	<p><b>No update file found</b></p> <p>No new update file was found on the SD memory card. The update failed. The inverter continues to feed in.</p>
7112	<p><b>Update file successfully copied</b></p>
7113	<p><b>The memory card is full or write-protected</b></p>
7201	<p><b>Data storage defective</b></p> <p><b>Corrective measures:</b></p> <ul style="list-style-type: none"> <li>• If this message is displayed again, contact the Service.</li> </ul>
7202	<p><b>Long term data defective</b></p> <p><b>Corrective measures:</b></p> <ul style="list-style-type: none"> <li>• If this message is displayed again, contact the Service.</li> </ul>
7303	<p><b>⚠ QUALIFIED PERSON</b></p> <p><b>Host computer update failed</b></p> <p>The cause must be determined by the Service.</p> <p><b>Corrective measures:</b></p> <ul style="list-style-type: none"> <li>• Contact the Service.</li> </ul>

Event number	Message, cause and corrective measures
7320	<b>The device with serial number [xx] was successfully updated to firmware version [xx].</b>
7324	<p><b>⚠ QUALIFIED PERSON</b></p> <p><b>Wait for update conditions</b></p> <p>The testing of the update conditions was not successful. The firmware update package is not suitable for this inverter.</p> <p><b>Corrective measures:</b></p> <ul style="list-style-type: none"> <li>• Retry update.</li> <li>• Ensure that the selected update file is suitable for this inverter.</li> <li>• If this message is displayed again, contact the Service.</li> </ul>
7330	<p><b>⚠ QUALIFIED PERSON</b></p> <p><b>Condition test failed</b></p> <p><b>Corrective measures:</b></p> <ul style="list-style-type: none"> <li>• Retry update.</li> <li>• Ensure that the selected update file is suitable for this inverter.</li> <li>• If this message is displayed again, contact the Service.</li> </ul>
7331	<p><b>Update transport started</b></p> <p>Update file is being copied.</p>
7332	<p><b>Update transport successful</b></p> <p>Update file was copied successfully to the inverter's internal memory.</p>
7333	<p><b>⚠ QUALIFIED PERSON</b></p> <p><b>Update transport failed</b></p> <p>Update file could not be copied to the inverter's internal memory. In the event of connection with the inverter via Wi-Fi network, a poor connection quality can be the cause.</p> <p><b>Corrective measures:</b></p> <ul style="list-style-type: none"> <li>• Retry update.</li> <li>• If this message is displayed again, contact the Service.</li> </ul>
7337	<p><b>⚠ QUALIFIED PERSON</b></p> <p><b>Battery management system update unsuccessful ([d0])</b></p> <p><b>Corrective measures:</b></p> <ul style="list-style-type: none"> <li>• Retry update.</li> <li>• Ensure that the selected update file is suitable for this inverter.</li> <li>• If this message is displayed again, contact the Service.</li> </ul>

Event number	Message, cause and corrective measures
7340	<b>Update communication failed</b>
7347	<p><b>⚠ QUALIFIED PERSON</b></p> <p><b>Incompatible file</b> The configuration file is not suitable for this inverter.</p> <p><b>Corrective measures:</b></p> <ul style="list-style-type: none"> <li>• Ensure that the selected configuration file is suitable for this inverter.</li> <li>• Retry import.</li> </ul>
7348	<p><b>⚠ QUALIFIED PERSON</b></p> <p><b>Incorrect file format</b> The configuration file is not of the required format or is damaged.</p> <p><b>Corrective measures:</b></p> <ul style="list-style-type: none"> <li>• Ensure that the selected configuration file is of the required format and is not damaged.</li> <li>• Retry import.</li> </ul>
7349	<p><b>Incorrect login rights for configuration file</b> The configuration file cannot be loaded.</p> <p><b>Corrective measures:</b></p> <ul style="list-style-type: none"> <li>• Ensure you are logged on in the correct user level to load the configuration file.</li> </ul>
7350	<p><b>Transfer of a configuration file has started</b> The configuration file is being transferred.</p>
7351	<p><b>Update Wi-Fi</b> The inverter is updating the Wi-Fi module.</p>
7352	<p><b>⚠ QUALIFIED PERSON</b></p> <p><b>Update of Wi-Fi not successful</b> The update of the Wi-Fi module failed.</p> <p><b>Corrective measures:</b></p> <ul style="list-style-type: none"> <li>• Retry update.</li> <li>• If this message is displayed again, contact the Service.</li> </ul>
7353	<p><b>Update time zone database</b> The inverter is updating the time zone database.</p>

Event number	Message, cause and corrective measures
7354	<p data-bbox="292 185 594 220"><b>⚠ QUALIFIED PERSON</b></p> <p data-bbox="292 236 748 263"><b>Update of time zone database not successful</b></p> <p data-bbox="292 272 703 300">The update of the time zone database failed.</p> <p data-bbox="292 309 508 336"><b>Corrective measures:</b></p> <ul data-bbox="311 346 832 405" style="list-style-type: none"> <li data-bbox="311 346 460 373">• Retry update.</li> <li data-bbox="311 378 832 405">• If this message is displayed again, contact the Service.</li> </ul>
7355	<p data-bbox="292 416 449 443"><b>Update WebUI</b></p> <p data-bbox="292 453 743 480">The inverter is updating the inverter user interface.</p>
7356	<p data-bbox="292 491 594 526"><b>⚠ QUALIFIED PERSON</b></p> <p data-bbox="292 542 656 569"><b>Update of the WebUI not successful</b></p> <p data-bbox="292 579 715 606">The update of the inverter user interface failed.</p> <p data-bbox="292 616 508 643"><b>Corrective measures:</b></p> <ul data-bbox="311 652 832 711" style="list-style-type: none"> <li data-bbox="311 652 460 679">• Retry update.</li> <li data-bbox="311 684 832 711">• If this message is displayed again, contact the Service.</li> </ul>
7357	<p data-bbox="292 722 415 750"><b>Update BIM</b></p> <p data-bbox="292 759 986 815">The Battery Interface Module on the communication assembly has been successfully updated.</p>
7358	<p data-bbox="292 826 594 861"><b>⚠ QUALIFIED PERSON</b></p> <p data-bbox="292 877 482 904"><b>Update BIM failed</b></p> <p data-bbox="292 914 981 970">The Battery Interface Module on the communication assembly has not been updated successfully.</p> <p data-bbox="292 979 508 1007"><b>Corrective measures:</b></p> <ul data-bbox="311 1016 832 1075" style="list-style-type: none"> <li data-bbox="311 1016 460 1043">• Retry update.</li> <li data-bbox="311 1048 832 1075">• If this message is displayed again, contact the Service.</li> </ul>
7359	<p data-bbox="292 1086 421 1114"><b>Update BUC</b></p> <p data-bbox="292 1123 956 1177">The SMA Backup Unit Controller that is installed in the automatic transfer switch has been updated successfully.</p>

Event number	Message, cause and corrective measures
7360	<p data-bbox="311 183 596 220"><b>⚠ QUALIFIED PERSON</b></p> <p data-bbox="288 231 484 263"><b>Update BUC failed</b></p> <p data-bbox="288 271 509 295"><b>Corrective measures:</b></p> <ul data-bbox="311 303 1012 518" style="list-style-type: none"> <li data-bbox="311 303 1012 359">• Ensure that the communication between SMA Backup Unit Controller and the inverter functions perfectly.</li> <li data-bbox="311 367 1012 454">• Ensure that the cable requirements of the communication cable for the communication between the SMA Backup Unit Controller and the inverter have been met.</li> <li data-bbox="311 462 459 486">• Retry update.</li> <li data-bbox="311 494 834 518">• If this message is displayed again, contact the Service.</li> </ul>
7619	<p data-bbox="311 534 596 571"><b>⚠ QUALIFIED PERSON</b></p> <p data-bbox="288 582 1002 614"><b>Communication fault with meter unit &gt; Check communication to meter</b></p> <p data-bbox="288 622 840 646">The inverter is not receiving any data from the energy meter.</p> <p data-bbox="288 654 509 678"><b>Corrective measures:</b></p> <ul data-bbox="311 686 1012 742" style="list-style-type: none"> <li data-bbox="311 686 1012 742">• Ensure that the energy meter is correctly integrated into the same network as the inverter (see energy meter manual).</li> </ul>
7623	<p data-bbox="311 758 596 794"><b>⚠ QUALIFIED PERSON</b></p> <p data-bbox="288 805 744 837"><b>Communication to backup module disrupted</b></p> <p data-bbox="288 845 1002 901">The communication between the inverter and the SMA Backup Unit Controller in the automatic transfer switch is disrupted.</p> <p data-bbox="288 909 509 933"><b>Corrective measures:</b></p> <ul data-bbox="311 941 1012 1181" style="list-style-type: none"> <li data-bbox="311 941 1012 1029">• Ensure that the cable requirements of the communication cable for the communication between the SMA Backup Unit Controller and the inverter have been met.</li> <li data-bbox="311 1037 459 1061">• Retry update.</li> <li data-bbox="311 1069 610 1093">• Carry out communication test.</li> <li data-bbox="311 1101 1012 1181">• If the communication test was successful, contact the manufacturer of the automatic transfer switch. If the communication test failed, contact the Service.</li> </ul>

Event number	Message, cause and corrective measures
7624	<p data-bbox="311 183 599 215"><b>⚠ QUALIFIED PERSON</b></p> <p data-bbox="288 231 840 263"><b>Communication to battery interface module disrupted</b></p> <p data-bbox="288 271 994 327">The communication between the inverter and the battery interface module on the communication assembly is disrupted.</p> <p data-bbox="288 335 509 359"><b>Corrective measures:</b></p> <ul data-bbox="311 367 1002 454" style="list-style-type: none"> <li>• Ensure that the ribbon cable is in perfect condition and securely in place.</li> <li>• If the ribbon cable is in perfect condition and firmly plugged in the jack, contact the Service.</li> </ul>
7701	<p data-bbox="311 470 599 502"><b>⚠ QUALIFIED PERSON</b></p> <p data-bbox="288 518 543 550"><b>Grid disconnection point</b></p> <p data-bbox="288 558 610 582">Grid relay of the inverter defective.</p> <p data-bbox="288 590 509 614"><b>Corrective measures:</b></p> <ul data-bbox="311 622 520 646" style="list-style-type: none"> <li>• Contact the Service.</li> </ul>
7702	<p data-bbox="288 670 420 694"><b>Relay defect</b></p> <p data-bbox="288 702 610 726">Grid relay of the inverter defective.</p> <p data-bbox="288 734 509 758"><b>Corrective measures:</b></p> <ul data-bbox="311 766 520 790" style="list-style-type: none"> <li>• Contact the Service.</li> </ul>
7703	<p data-bbox="311 813 599 845"><b>⚠ QUALIFIED PERSON</b></p> <p data-bbox="288 861 431 885"><b>24h relay test</b></p> <p data-bbox="288 893 442 917">Relay test failed.</p> <p data-bbox="288 933 509 957"><b>Corrective measures:</b></p> <ul data-bbox="311 965 834 989" style="list-style-type: none"> <li>• If this message is displayed again, contact the Service.</li> </ul>
8003	<p data-bbox="311 1013 599 1045"><b>⚠ QUALIFIED PERSON</b></p> <p data-bbox="288 1061 610 1085"><b>Active power limit temperature</b></p> <p data-bbox="288 1093 1002 1149">The inverter has reduced its power output for more than 10 minutes due to excessive temperature.</p> <p data-bbox="288 1157 509 1181"><b>Corrective measures:</b></p> <ul data-bbox="311 1189 980 1348" style="list-style-type: none"> <li>• Clean the cooling fins on the rear of the enclosure and the air ducts on the top using a soft brush.</li> <li>• Ensure that the inverter has sufficient ventilation.</li> <li>• Ensure that the ambient temperature +45 °C has not been exceeded.</li> <li>• Ensure that the inverter is not exposed to direct solar irradiation.</li> </ul>

Event number	Message, cause and corrective measures
8101	<p><b>⚠ QUALIFIED PERSON</b></p> <p><b>Main memory defective</b></p> <p><b>Corrective measures:</b></p> <ul style="list-style-type: none"> <li>• If this message is displayed again, contact the Service.</li> </ul>
8102	<p><b>⚠ QUALIFIED PERSON</b></p> <p><b>Code memory defective</b></p> <p><b>Corrective measures:</b></p> <ul style="list-style-type: none"> <li>• If this message is displayed again, contact the Service.</li> </ul>
8103	<p><b>⚠ QUALIFIED PERSON</b></p> <p><b>CPU self-test HP</b></p> <p>The self-test failed.</p> <p><b>Corrective measures:</b></p> <ul style="list-style-type: none"> <li>• If this message is displayed again, contact the Service.</li> </ul>
8104	<p><b>⚠ QUALIFIED PERSON</b></p> <p><b>internal communication</b></p> <p><b>Corrective measures:</b></p> <ul style="list-style-type: none"> <li>• If this message is displayed again, contact the Service.</li> </ul>
8501	<p><b>⚠ QUALIFIED PERSON</b></p> <p><b>DC current sensor C offset</b></p> <p><b>Corrective measures:</b></p> <ul style="list-style-type: none"> <li>• If this message is displayed again, contact the Service.</li> </ul>
8502	<p><b>⚠ QUALIFIED PERSON</b></p> <p><b>DC converter string C defective</b></p> <p><b>Corrective measures:</b></p> <ul style="list-style-type: none"> <li>• If this message is displayed again, contact the Service.</li> </ul>
8708	<p><b>⚠ QUALIFIED PERSON</b></p> <p><b>Timeout in communication for active power limitation</b></p> <p>Communication to the system control absent. Depending on the fallback setting, either the last received values will be retained or the active power will be limited to the set percentage value of the inverter nominal power.</p> <p><b>Corrective measures:</b></p> <ul style="list-style-type: none"> <li>• Ensure that the connection to the system control is intact and that no cables are damaged or that no plugs have been pulled.</li> </ul>



Event number	Message, cause and corrective measures
8709	<p data-bbox="311 183 595 220"><b>⚠ QUALIFIED PERSON</b></p> <p data-bbox="288 236 842 263"><b>Timeout in communication for reactive power setpoint</b></p> <p data-bbox="288 271 1003 354">Communication to the system control absent. Depending on the fallback setting, either the last received values will be retained or the active power will be limited to the set percentage value of the inverter nominal power.</p> <p data-bbox="288 363 506 391"><b>Corrective measures:</b></p> <ul data-bbox="311 399 954 454" style="list-style-type: none"> <li>• Ensure that the connection to the system control is intact and that no cables are damaged or that no plugs have been pulled.</li> </ul>
8710	<p data-bbox="311 467 595 504"><b>⚠ QUALIFIED PERSON</b></p> <p data-bbox="288 520 759 547"><b>Timeout in communication for cos phi setpoint</b></p> <p data-bbox="288 555 1003 638">Communication to the system control absent. Depending on the fallback setting, either the last received values will be retained or the active power will be limited to the set percentage value of the inverter nominal power.</p> <p data-bbox="288 647 506 675"><b>Corrective measures:</b></p> <ul data-bbox="311 683 954 738" style="list-style-type: none"> <li>• Ensure that the connection to the system control is intact and that no cables are damaged or that no plugs have been pulled.</li> </ul>
9002	<p data-bbox="311 751 595 788"><b>⚠ QUALIFIED PERSON</b></p> <p data-bbox="288 804 598 831"><b>SMA Grid Guard code invalid</b></p> <p data-bbox="288 839 1003 890">The SMA Grid Guard code entered is incorrect. The operating parameters are still protected and cannot be changed.</p> <p data-bbox="288 900 506 927"><b>Corrective measures:</b></p> <ul data-bbox="311 935 710 962" style="list-style-type: none"> <li>• Enter the correct SMA Grid Guard code.</li> </ul>
9003	<p data-bbox="288 975 537 1002"><b>Grid parameters locked</b></p> <p data-bbox="288 1010 1003 1093">Changes to the grid parameters are now blocked. In order to be able to make changes to the grid parameters, from now on you must log in using the SMA Grid Guard code.</p>
9005	<p data-bbox="311 1110 595 1147"><b>⚠ QUALIFIED PERSON</b></p> <p data-bbox="288 1163 922 1190"><b>Changing of grid parameters not possible &gt; Ensure DC supply</b></p> <p data-bbox="288 1198 663 1225">This error can have the following causes:</p> <ul data-bbox="311 1233 954 1289" style="list-style-type: none"> <li>• The parameters to be changed are protected.</li> <li>• The DC voltage at the DC input is not sufficient to run the main CPU.</li> </ul> <p data-bbox="288 1299 506 1326"><b>Corrective measures:</b></p> <ul data-bbox="311 1334 934 1425" style="list-style-type: none"> <li>• Enter the SMA Grid Guard code.</li> <li>• Ensure that at least the DC start voltage is available (green LED is flashing, pulsing or glowing).</li> </ul>

Event number	Message, cause and corrective measures
9007	<p data-bbox="292 181 596 220"><b>⚠ QUALIFIED PERSON</b></p> <p data-bbox="292 236 432 260"><b>Abort self-test</b></p> <p data-bbox="292 272 544 296">The self-test was terminated.</p> <p data-bbox="292 309 507 333"><b>Corrective measures:</b></p> <ul data-bbox="311 341 507 365" style="list-style-type: none"> <li data-bbox="311 341 507 365">• Restart the self-test.</li> </ul>
9202	<p data-bbox="292 381 596 419"><b>⚠ QUALIFIED PERSON</b></p> <p data-bbox="292 435 497 459"><b>SPS AC overvoltage</b></p> <p data-bbox="292 472 1003 520">An AC source has been connected to the outlet for secure power supply operation.</p> <p data-bbox="292 533 507 557"><b>Corrective measures:</b></p> <ul data-bbox="311 564 919 620" style="list-style-type: none"> <li data-bbox="311 564 919 620">• Check the connection at the <b>SPS</b> slots, and make any necessary corrections.</li> </ul>
9203	<p data-bbox="292 636 596 675"><b>⚠ QUALIFIED PERSON</b></p> <p data-bbox="292 691 656 715"><b>Short circuit in the SPS power outlet</b></p> <p data-bbox="292 727 1003 807">The maximum initial load has been overshoot or the appliance's initial current is above the maximum permissible load current of the terminal for secure power supply operation for more than 5 s.</p> <p data-bbox="292 820 507 844"><b>Corrective measures:</b></p> <ul data-bbox="311 852 947 908" style="list-style-type: none"> <li data-bbox="311 852 947 876">• Reduce the load at the terminal for secure power supply operation.</li> <li data-bbox="311 884 880 908">• If necessary, select an appliance with a lower initial current.</li> </ul>
9204	<p data-bbox="292 924 596 962"><b>⚠ QUALIFIED PERSON</b></p> <p data-bbox="292 978 592 1002"><b>AC overvoltage backup (fast)</b></p> <p data-bbox="292 1015 1003 1062">Voltage in the battery-backup grid too high or step changes in load too high in the battery-backup grid.</p> <p data-bbox="292 1075 507 1099"><b>Corrective measures:</b></p> <ul data-bbox="311 1107 997 1206" style="list-style-type: none"> <li data-bbox="311 1107 997 1131">• Check whether there is a new firmware version available for the inverter.</li> <li data-bbox="311 1139 885 1163">• If a newer version is available, perform the firmware update.</li> <li data-bbox="311 1171 841 1206">• If no new firmware version is available, contact Service.</li> </ul>

Event number	Message, cause and corrective measures
9205	<p data-bbox="311 183 593 215"><b>⚠ QUALIFIED PERSON</b></p> <p data-bbox="288 231 604 263"><b>AC overvoltage backup (slow)</b></p> <p data-bbox="288 271 1012 327">Voltage in the battery-backup grid too high or step changes in load too high in the battery-backup grid.</p> <p data-bbox="288 335 504 359"><b>Corrective measures:</b></p> <ul data-bbox="311 367 996 462" style="list-style-type: none"> <li>• Check whether there is a new firmware version available for the inverter.</li> <li>• If a newer version is available, perform the firmware update.</li> <li>• If no new firmware version is available, contact Service.</li> </ul>
9206	<p data-bbox="311 478 593 510"><b>⚠ QUALIFIED PERSON</b></p> <p data-bbox="288 526 515 558"><b>Short circuit in backup</b></p> <p data-bbox="288 566 672 590">Loads in the battery-backup grid too high.</p> <p data-bbox="288 598 504 622"><b>Corrective measures:</b></p> <ul data-bbox="311 630 515 686" style="list-style-type: none"> <li>• Reduce loads.</li> <li>• Contact the Service.</li> </ul>
9207	<p data-bbox="311 710 593 742"><b>⚠ QUALIFIED PERSON</b></p> <p data-bbox="288 758 604 790"><b>Backup module bimetal switch</b></p> <p data-bbox="288 798 672 821">Automatic transfer switching device error.</p> <p data-bbox="288 829 504 853"><b>Corrective measures:</b></p> <ul data-bbox="311 861 952 885" style="list-style-type: none"> <li>• Contact the manufacturer of the automatic transfer switching device.</li> </ul>
9208	<p data-bbox="311 909 593 941"><b>⚠ QUALIFIED PERSON</b></p> <p data-bbox="288 957 616 989"><b>Backup module relay error [d0]</b></p> <p data-bbox="288 997 750 1021">Relay in automatic transfer switching device faulty.</p> <p data-bbox="288 1029 504 1053"><b>Corrective measures:</b></p> <ul data-bbox="311 1061 952 1085" style="list-style-type: none"> <li>• Contact the manufacturer of the automatic transfer switching device.</li> </ul>
9209	<p data-bbox="311 1109 593 1141"><b>⚠ QUALIFIED PERSON</b></p> <p data-bbox="288 1157 616 1189"><b>N-PE monitoring backup module</b></p> <p data-bbox="288 1197 504 1220"><b>Corrective measures:</b></p> <ul data-bbox="311 1228 952 1252" style="list-style-type: none"> <li>• Contact the manufacturer of the automatic transfer switching device.</li> </ul>
9211	<p data-bbox="311 1268 593 1300"><b>⚠ QUALIFIED PERSON</b></p> <p data-bbox="288 1316 627 1348"><b>Backup module overtemperature</b></p> <p data-bbox="288 1356 504 1380"><b>Corrective measures:</b></p> <ul data-bbox="311 1388 952 1444" style="list-style-type: none"> <li>• Check the installation of the automatic transfer switching device.</li> <li>• Contact the manufacturer of the automatic transfer switching device.</li> </ul>

Event number	Message, cause and corrective measures
9214	<p data-bbox="311 185 596 220"><b>⚠ QUALIFIED PERSON</b></p> <p data-bbox="288 236 647 263"><b>Black start battery voltage too low</b></p> <p data-bbox="288 272 1010 355">The service life of the backup battery has expired. The backup battery must be replaced when you want to use the black start for the battery-backup function or the secure power supply operation.</p> <p data-bbox="288 365 508 389"><b>Corrective measures:</b></p> <ul data-bbox="311 399 822 456" style="list-style-type: none"> <li data-bbox="311 399 822 426">• Procure new backup battery and exchange batteries.</li> <li data-bbox="311 432 519 456">• Contact the Service.</li> </ul>
9215	<p data-bbox="311 472 596 507"><b>⚠ QUALIFIED PERSON</b></p> <p data-bbox="288 523 712 550"><b>Battery interface module hardware error</b></p> <p data-bbox="288 560 665 584">The battery interface module is defective.</p> <p data-bbox="288 593 508 617"><b>Corrective measures:</b></p> <ul data-bbox="311 627 519 651" style="list-style-type: none"> <li data-bbox="311 627 519 651">• Contact the Service.</li> </ul>
9216	<p data-bbox="311 668 596 703"><b>⚠ QUALIFIED PERSON</b></p> <p data-bbox="288 719 533 746"><b>Supply voltage too low</b></p> <p data-bbox="288 756 508 780"><b>Corrective measures:</b></p> <ul data-bbox="311 790 973 879" style="list-style-type: none"> <li data-bbox="311 790 973 842">• Check whether the ribbon cable between the inverter and the battery interface module on the communication assembly is correctly inserted.</li> <li data-bbox="311 849 833 879">• If this message is displayed again, contact the Service.</li> </ul>
9217	<p data-bbox="311 892 596 927"><b>⚠ QUALIFIED PERSON</b></p> <p data-bbox="288 943 1001 1002"><b>Output supply voltage of the battery interface module too low  xx   xx </b></p> <p data-bbox="288 1011 508 1035"><b>Corrective measures:</b></p> <ul data-bbox="311 1045 975 1134" style="list-style-type: none"> <li data-bbox="311 1045 975 1098">• Check whether the plugs for connecting the battery and the automatic transfer switching device are correctly inserted.</li> <li data-bbox="311 1104 833 1134">• If this message is displayed again, contact the Service.</li> </ul>
9218	<p data-bbox="311 1147 596 1182"><b>⚠ QUALIFIED PERSON</b></p> <p data-bbox="288 1198 947 1225"><b>Battery interface module output communication error  xx   xx </b></p> <p data-bbox="288 1235 508 1259"><b>Corrective measures:</b></p> <ul data-bbox="311 1268 975 1358" style="list-style-type: none"> <li data-bbox="311 1268 975 1321">• Check whether the plugs for connecting the battery and the automatic transfer switching device are correctly inserted.</li> <li data-bbox="311 1327 609 1358">• Carry out communication test.</li> </ul>

Event number	Message, cause and corrective measures
9219	<p><b>⚠ QUALIFIED PERSON</b></p> <p><b>Battery interface module output communication error  xx   xx </b></p> <p><b>Corrective measures:</b></p> <ul style="list-style-type: none"> <li>• Ensure that only one node each is connected to the terminal for the communication cables of the battery and the automatic transfer switching device.</li> </ul>
9220	<p><b>Battery interface module test mode  xx , success rate:  xx </b></p> <p>The communication test was successful.</p>
9221	<p><b>⚠ QUALIFIED PERSON</b></p> <p><b>Limitation of the switching frequency of the input relay for current limitation</b></p> <p>There are too many faulty control commands by the system control.</p> <p><b>Corrective measures:</b></p> <ul style="list-style-type: none"> <li>• Check system control.</li> </ul>
9223	<p><b>Backup operation</b></p> <p>The battery-backup function is enabled.</p>
9301	<p><b>New battery detected</b></p>
9303	<p><b>⚠ QUALIFIED PERSON</b></p> <p><b>The service life of the battery is expiring</b></p> <p>The battery can fail anytime.</p> <p><b>Corrective measures:</b></p> <ul style="list-style-type: none"> <li>• Procure new battery and exchange batteries.</li> </ul>
9304	<p><b>⚠ QUALIFIED PERSON</b></p> <p><b>Battery connection fault</b></p> <p><b>Corrective measures:</b></p> <ul style="list-style-type: none"> <li>• Check terminal for the data cable of the battery.</li> <li>• Carry out communication test.</li> </ul>
9305	<p><b>⚠ QUALIFIED PERSON</b></p> <p><b>Unauthorized battery system</b></p> <p><b>Corrective measures:</b></p> <ul style="list-style-type: none"> <li>• Check whether there is a new firmware version available for the battery. If a newer version is available, perform the firmware update.</li> <li>• If this message is displayed again, contact the Service (see Section 1.5, page 146).</li> </ul>

Event number	Message, cause and corrective measures
9306	<p data-bbox="311 188 596 220"><b>⚠ QUALIFIED PERSON</b></p> <p data-bbox="288 236 580 268"><b>Deviation in battery voltage</b></p> <p data-bbox="288 276 507 300"><b>Corrective measures:</b></p> <ul data-bbox="311 308 985 395" style="list-style-type: none"> <li data-bbox="311 308 574 331">• Check the DC connection.</li> <li data-bbox="311 339 985 395">• If this message is displayed again, contact the Service (see Section 15, page 146).</li> </ul>
9307	<p data-bbox="311 416 596 448"><b>⚠ QUALIFIED PERSON</b></p> <p data-bbox="288 464 540 488"><b>Battery system defective</b></p> <p data-bbox="288 496 507 520"><b>Corrective measures:</b></p> <ul data-bbox="311 528 641 552" style="list-style-type: none"> <li data-bbox="311 528 641 552">• Contact the battery manufacturer.</li> </ul>
9308	<p data-bbox="311 576 596 608"><b>⚠ QUALIFIED PERSON</b></p> <p data-bbox="288 624 664 647"><b>Communication error battery system</b></p> <p data-bbox="288 655 507 679"><b>Corrective measures:</b></p> <ul data-bbox="311 687 977 775" style="list-style-type: none"> <li data-bbox="311 687 977 775">• Carry out communication test. If the test was successful, contact the battery manufacturer. If the test was not successful, contact the Service (see Section 15, page 146).</li> </ul>
9311	<p data-bbox="311 799 596 831"><b>⚠ QUALIFIED PERSON</b></p> <p data-bbox="288 847 591 871"><b>Battery cell overvoltage fault</b></p> <p data-bbox="288 879 507 903"><b>Corrective measures:</b></p> <ul data-bbox="311 911 641 935" style="list-style-type: none"> <li data-bbox="311 911 641 935">• Contact the battery manufacturer.</li> </ul>
9312	<p data-bbox="311 959 596 991"><b>⚠ QUALIFIED PERSON</b></p> <p data-bbox="288 1007 602 1031"><b>Battery cell undervoltage fault</b></p> <p data-bbox="288 1038 507 1062"><b>Corrective measures:</b></p> <ul data-bbox="311 1070 641 1094" style="list-style-type: none"> <li data-bbox="311 1070 641 1094">• Contact the battery manufacturer.</li> </ul>
9313	<p data-bbox="311 1118 596 1150"><b>⚠ QUALIFIED PERSON</b></p> <p data-bbox="288 1166 596 1190"><b>Battery low temperature fault</b></p> <p data-bbox="288 1198 507 1222"><b>Corrective measures:</b></p> <ul data-bbox="311 1230 641 1254" style="list-style-type: none"> <li data-bbox="311 1230 641 1254">• Contact the battery manufacturer.</li> </ul>
9314	<p data-bbox="311 1278 596 1310"><b>⚠ QUALIFIED PERSON</b></p> <p data-bbox="288 1326 546 1350"><b>Battery overtemperature</b></p> <p data-bbox="288 1358 507 1382"><b>Corrective measures:</b></p> <ul data-bbox="311 1390 641 1414" style="list-style-type: none"> <li data-bbox="311 1390 641 1414">• Contact the battery manufacturer.</li> </ul>

Event number	Message, cause and corrective measures
9315	<p><b>⚠ QUALIFIED PERSON</b></p> <p><b>Battery imbalancing fault</b></p> <p><b>Corrective measures:</b></p> <ul style="list-style-type: none"> <li>• Contact the battery manufacturer.</li> </ul>
9316	<p><b>⚠ QUALIFIED PERSON</b></p> <p><b>Internal battery hardware fault</b></p> <p><b>Corrective measures:</b></p> <ul style="list-style-type: none"> <li>• Contact the battery manufacturer.</li> </ul>
9334	<p><b>Battery charging test</b></p> <p>The battery test for charging the battery is carried out.</p>
9335	<p><b>Discharge battery test</b></p> <p>The battery test for discharging the battery is carried out.</p>
9336	<p><b>⚠ QUALIFIED PERSON</b></p> <p><b>Start conditions for battery test not fulfilled</b></p> <p>The state of charge of the battery is too low or too high for carrying out the test.</p> <p><b>Corrective measures:</b></p> <ul style="list-style-type: none"> <li>• Perform the test that has not been performed yet.</li> </ul>
9337	<p><b>Charge battery test successful</b></p>
9338	<p><b>Battery discharging test successful</b></p>
9339	<p><b>⚠ QUALIFIED PERSON</b></p> <p><b>Battery charging test failed</b></p> <p><b>Corrective measures:</b></p> <ul style="list-style-type: none"> <li>• Check the installation of the battery.</li> <li>• Perform the test that has not been performed yet.</li> </ul>
9340	<p><b>⚠ QUALIFIED PERSON</b></p> <p><b>Battery discharging test failed</b></p> <p><b>Corrective measures:</b></p> <ul style="list-style-type: none"> <li>• Check the installation of the battery.</li> <li>• Perform the test that has not been performed yet.</li> </ul>

Event number	Message, cause and corrective measures
9345	<p><b>⚠ QUALIFIED PERSON</b></p> <p><b>Battery charging for start process too low</b></p> <p><b>Corrective measures:</b></p> <ul style="list-style-type: none"> <li>• Contact the battery manufacturer.</li> </ul>
9346	<p><b>⚠ QUALIFIED PERSON</b></p> <p><b>Battery not configured</b></p> <p><b>Corrective measures:</b></p> <ul style="list-style-type: none"> <li>• Start the installation assistant on the inverter user interface and perform the battery configuration.</li> </ul>
9347	<p><b>⚠ QUALIFIED PERSON</b></p> <p><b>Battery  b0  reports event: 0x x5   x4 , 0x x7   x6 , 0x x9   x8 , 0x xB   xA </b></p> <p><b>Corrective measures:</b></p> <ul style="list-style-type: none"> <li>• Contact the battery manufacturer.</li> </ul>
9351	<p><b>⚠ QUALIFIED PERSON</b></p> <p><b>Incorrect switch position for the battery disconnection point</b></p> <p><b>Corrective measures:</b></p> <ul style="list-style-type: none"> <li>• Contact the battery manufacturer.</li> </ul>
9352	<p><b>⚠ QUALIFIED PERSON</b></p> <p><b>Battery system short circuit</b></p> <p><b>Corrective measures:</b></p> <ul style="list-style-type: none"> <li>• Contact the battery manufacturer.</li> </ul>
9353	<p><b>⚠ QUALIFIED PERSON</b></p> <p><b>Battery system thermal management defective</b></p> <p><b>Corrective measures:</b></p> <ul style="list-style-type: none"> <li>• Check whether there is a new firmware version available for the battery. If a newer version is available, perform the firmware update.</li> <li>• If this message is displayed again, contact the battery manufacturer.</li> </ul>



Event number	Message, cause and corrective measures
9354	<p><b>⚠ QUALIFIED PERSON</b></p> <p><b>Battery system heating procedure unsuccessful</b></p> <p><b>Corrective measures:</b></p> <ul style="list-style-type: none"> <li>• Check whether there is a new firmware version available for the battery. If a newer version is available, perform the firmware update.</li> <li>• If this message is displayed again, contact the battery manufacturer.</li> </ul>
10100	<b>Parameter [xxx] set successfully.  xxxx  to  xxxx </b>
10101	<p><b>Setting of parameter  ln04  failed.  xxxx  to  xxxx </b></p> <p><b>Corrective measures:</b></p> <ul style="list-style-type: none"> <li>• Change parameter again and save change.</li> </ul>
10102	<b>Parameter [xxx] set successfully.  xxx  to  xxx </b>
10103	<p><b>Setting of parameter [xxxx] failed.  xxx  to  xxx </b></p> <p><b>Corrective measures:</b></p> <ul style="list-style-type: none"> <li>• Change parameter again and save change.</li> </ul>
10104	<b>Parameter [xxxx] set successfully</b>
10105	<p><b>Setting of parameter  xxxx  failed.</b></p> <p><b>Corrective measures:</b></p> <ul style="list-style-type: none"> <li>• Change parameter again and save change.</li> </ul>
10108	<b>Time adjusted / old time</b>
10109	<b>Time adjusted / new time</b>
10110	<p><b>Time synchronization failed: [x]</b></p> <p>No time information could be called up from the set NTP server.</p> <p><b>Corrective measures:</b></p> <ul style="list-style-type: none"> <li>• Ensure that the NTP server was configured correctly.</li> <li>• Ensure that the inverter is integrated into a local network with Internet connection.</li> </ul>
10116	<b>Setting of parameter [xxxx] failed. Conflict with parameter  xxxx </b>
10118	<b>Parameter upload complete</b>
10120	<b>Currently permitted number of parameterizations exceeded</b>
10224	<b>Dynamic settings established</b>

Event number	Message, cause and corrective measures
10248	<p><b>[tn4]: network busy</b></p> <p>The network is busy. Data exchange between the devices is not at an optimum and is greatly delayed.</p> <p><b>Corrective measures:</b></p> <ul style="list-style-type: none"> <li>• Reduce the number of devices in the network.</li> <li>• If necessary, increase the data query intervals.</li> <li>• If necessary, reduce the number of devices in the network.</li> </ul>
10249	<p><b>⚠ QUALIFIED PERSON</b></p> <p><b>[tn4]: network overloaded</b></p> <p>The network is busy. Data exchange between the devices is not at an optimum and is greatly delayed.</p> <p><b>Corrective measures:</b></p> <ul style="list-style-type: none"> <li>• Reduce the number of devices in the network.</li> <li>• If necessary, increase the data query intervals.</li> <li>• If necessary, reduce the number of devices in the network.</li> </ul>
10250	<p><b>⚠ QUALIFIED PERSON</b></p> <p><b>[Interface]: package error rate [ok / high]</b></p> <p>The package error rate has changed. If the package error rate is high, the network is overloaded or the connection to the network switch or DHCP server (router) is impaired.</p> <p><b>Corrective measures if the package error rate is high:</b></p> <ul style="list-style-type: none"> <li>• Ensure that with an Ethernet connection, the network cable and the network connector are not damaged and that the network connectors are correctly plugged.</li> <li>• If necessary, increase the data query intervals.</li> <li>• If necessary, reduce the number of devices in the network.</li> </ul>
10251	<p><b>[Interface]: communication status goes to [OK / Warning / Error / Not connected]</b></p> <p>The communication status to the network switch or DHCP server (router) has changed. An additional error message may be displayed.</p>

Event number	Message, cause and corrective measures
10252	<p data-bbox="308 183 593 215"><b>⚠ QUALIFIED PERSON</b></p> <p data-bbox="285 231 672 263"><b>[Interface]: communication disrupted</b></p> <p data-bbox="285 271 688 295">There is no valid signal on the network line.</p> <p data-bbox="285 303 509 327"><b>Corrective measures:</b></p> <ul data-bbox="308 335 1008 478" style="list-style-type: none"> <li data-bbox="308 335 1008 422">• Ensure that with an Ethernet connection, the network cable and the network connector are not damaged and that the network connectors are correctly plugged.</li> <li data-bbox="308 430 1008 478">• Ensure that the DHCP server (router) and any network switches are signaling correct operation.</li> </ul>
10253	<p data-bbox="308 502 593 534"><b>⚠ QUALIFIED PERSON</b></p> <p data-bbox="285 550 890 582"><b>[Interface]: connection speed goes to [100 Mbit / 10 Mbit]</b></p> <p data-bbox="285 590 1002 670">The data transfer rate has changed. The cause for the status [10 Mbit] can be a defective plug, a defective cable or the pulling or plugging of the network connector.</p> <p data-bbox="285 678 756 710"><b>Corrective measures if the status is [10 Mbit]:</b></p> <ul data-bbox="308 718 1008 853" style="list-style-type: none"> <li data-bbox="308 718 1008 798">• Ensure that with an Ethernet connection, the network cable and the network connector are not damaged and that the network connectors are correctly plugged.</li> <li data-bbox="308 805 1008 853">• Ensure that the DHCP server (router) and any network switches are signaling correct operation.</li> </ul>
10254	<p data-bbox="308 877 593 909"><b>⚠ QUALIFIED PERSON</b></p> <p data-bbox="285 925 756 957"><b>[Interface]: duplex mode goes to [Full / Half]</b></p> <p data-bbox="285 965 1002 1045">The duplex mode (data transfer mode) has changed. The cause for the status [Half] can be a defective plug, a defective cable or the pulling or plugging of the network connector.</p> <p data-bbox="285 1053 716 1085"><b>Corrective measures if the status is [Half]:</b></p> <ul data-bbox="308 1093 1008 1228" style="list-style-type: none"> <li data-bbox="308 1093 1008 1173">• Ensure that with an Ethernet connection, the network cable and the network connector are not damaged and that the network connectors are correctly plugged.</li> <li data-bbox="308 1181 1008 1228">• Ensure that the DHCP server (router) and any network switches are signaling correct operation.</li> </ul>
10255	<p data-bbox="285 1252 599 1284"><b>[Interface]: Network load OK</b></p> <p data-bbox="285 1292 901 1316">The network load has returned to a normal range after being busy.</p>

Event number	Message, cause and corrective measures
10282	<p><b>[User group]-Login via [protocol] locked</b></p> <p>After several incorrect login attempts, login has been blocked for a limited time. In this case, the User login will be blocked for 15 minutes, the Grid Guard login for 12 hours.</p> <p><b>Corrective measures:</b></p> <ul style="list-style-type: none"> <li>• Wait until the given time has expired and then retry login.</li> </ul>
10283	<p><b>Wi-Fi module faulty</b></p> <p>The Wi-Fi module integrated in the inverter is defective.</p> <p><b>Corrective measures:</b></p> <ul style="list-style-type: none"> <li>• Contact the Service.</li> </ul>
10284	<p><b>⚠ QUALIFIED PERSON</b></p> <p><b>No Wi-Fi connection possible</b></p> <p>The inverter does not currently have a Wi-Fi connection to the selected network.</p> <p><b>Corrective measures:</b></p> <ul style="list-style-type: none"> <li>• Ensure that the SSID, the Wi-Fi password and the encryption method have been entered correctly. The encryption method is specified by your Wi-Fi router or Wi-Fi access point and can be changed there.</li> <li>• Ensure that the Wi-Fi router or Wi-Fi access point is in range and is signaling correct operation.</li> <li>• If this message is displayed often, improve the WLAN connection by using a WLAN repeater (e.g. SMA Antenna Extension Kit).</li> </ul>
10285	<p><b>Wi-Fi connection established</b></p> <p>Connection to the selected Wi-Fi network has been established.</p>
10286	<p><b>⚠ QUALIFIED PERSON</b></p> <p><b>Wi-Fi connection lost</b></p> <p>The inverter has lost Wi-Fi connection to the selected network.</p> <p><b>Corrective measures:</b></p> <ul style="list-style-type: none"> <li>• Ensure that the Wi-Fi router or Wi-Fi access point is still active.</li> <li>• Ensure that the Wi-Fi router or Wi-Fi access point is in range and is signaling correct operation.</li> <li>• If this message is displayed often, improve the WLAN connection by using a WLAN repeater (e.g. SMA Antenna Extension Kit).</li> </ul>
10287	<p><b>Wi-Fi module detected</b></p>
10339	<p><b>Webconnect enabled</b></p> <p>The inverter can communicate with Sunny Portal without an additional SMA communications product (e.g. Sunny Data Manager).</p>

Event number	Message, cause and corrective measures
10340	<p><b>Webconnect disabled</b></p> <p>The Webconnect function has been switched off. This means that the inverter can not communicate with Sunny Portal without an additional SMA communications product (e.g. Sunny Data Manager).</p> <ul style="list-style-type: none"> <li>• If the inverter is to communicate with Sunny Portal without an additional SMA communication product, switch the Webconnect function on.</li> </ul>
10341	<p><b>Webconnect error: no connection</b></p> <p>It is likely that there is an error in the network settings.</p> <p><b>Corrective measures:</b></p> <ul style="list-style-type: none"> <li>• Check the network components (DLAN, WLAN Access Point etc.).</li> <li>• Ensure that the following ports are not blocked: <ul style="list-style-type: none"> <li>- Registrar: ied.sma.de:9523</li> <li>- Proxy: ied.sma.de:9523</li> <li>- Stun: stun.sma.de:3478</li> <li>- Domain: ied.sma.de (for SIP URI)</li> </ul> </li> </ul>
10343	<p><b>Webconnect error: Default gateway not configured</b></p> <p>It is likely that there is an error in the network settings.</p> <p><b>Corrective measures:</b></p> <ul style="list-style-type: none"> <li>• Check the network components (e.g. DLAN, Wi-Fi access point).</li> <li>• Ensure that the following ports are not blocked: <ul style="list-style-type: none"> <li>- Registrar: ied.sma.de:9523</li> <li>- Proxy: ied.sma.de:9523</li> <li>- Stun: stun.sma.de:3478</li> <li>- Domain: ied.sma.de (for SIP URI)</li> </ul> </li> </ul>
10420	<b>Self-consumption control was started</b>
10421	<b>Self-consumption control was stopped</b>
10513	<b>NSS quick stop: [tn0] through [tn4] is executed</b>
10517	<b>Dynamic active power limitation started.</b>
10518	<b>Dynamic active power limitation terminated.</b>
10520	<b>Supplied power: [u0] W (permitted value: [u4] W)</b>
10521	<b>Active power was limited today for [u0] minutes.</b>
10525	<b>Inverter does not respond to active power limitation.</b>
10528	<b>Login for NSD function on device [s0] failed</b>

<b>Event number</b>	<b>Message, cause and corrective measures</b>
27107	<b>Update file OK</b> The update file is suitable for this inverter and its components and is fully available for the next update step.
27108	<b>Memory card is being read</b> The storage medium is being read.
27109	<b>No new update on the memory card</b> A new update file was not found on the storage medium.
27301	<b>Update communication</b> The inverter is updating the communication component.
27302	<b>Update main CPU</b> The inverter is updating the inverter component.
27312	<b>Update completed</b> The inverter has successfully completed the update.
27329	<b>Condition test successful</b>
27331	<b>Update transport started</b> The inverter has successfully started the update.
27332	<b>Update transport successful</b> The update file has been successfully transferred to the communication component.
27336	<b>Battery management system</b>
29001	<b>Inst. code valid</b> The entered Grid Guard code is valid. Protected parameters have now been unlocked and you can adjust the parameters. The parameters will be automatically locked again after 10 feed-in hours.
29004	<b>Grid parameter unchanged</b> Changing the grid parameters is not possible.
29006	<b>Self-test</b>
29016	<b>Stand-alone operation</b>
29252	<b>SPS mode not available</b> The battery's state of charge is insufficient to supply the loads in secure power supply operation.

Event number	Message, cause and corrective measures
29253	<b>Input power for backup too low</b> The battery's state of charge is insufficient to supply the loads in the battery-backup grid.
29254	<b>Input power for SPS too low</b> The battery's state of charge is insufficient to supply the loads in secure power supply operation.

### 11.3 Problems with streaming services

If you use the streaming service in your local network (in which the inverter is also included), there may be interference to the transfer of data. In this case, the IGMP settings of the inverter can be changed via operating parameters.

- Contact the Service and change IGMP settings in consultation with the Service department.

## 12 Decommissioning the Inverter

### ⚠ QUALIFIED PERSON

To decommission the inverter completely upon completion of its service life, proceed as described in this Section.

### ⚠ CAUTION

#### Risk of injury due to weight of product

Injuries may result if the product is lifted incorrectly or dropped while being transported or mounted.

- Transport and lift the product carefully. Take the weight of the product into account.
- Wear suitable personal protective equipment for all work on the product.

#### Procedure:

1.

### ⚠ DANGER

#### Danger to life due to high voltages

- Disconnect the inverter from all voltage sources (see Section 9, page 96).

2. Remove the DC cable from the terminal blocks for the DC connection.

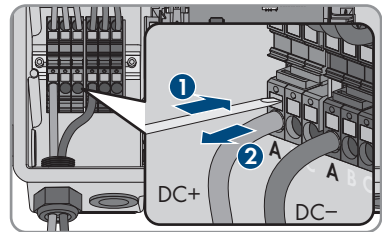

3. Remove the AC conductors from the **AC-out** terminal block. To release the conductors from the terminals, open the terminals with a flat-blade screwdriver (blade width: 3.5 mm).

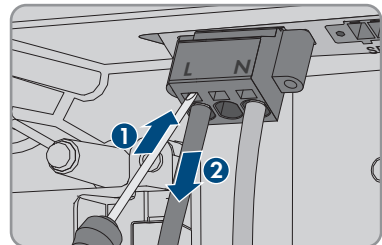

4. Screw out the screws from the **AC-out** terminal block using a flat-blade screwdriver (blade width: 3.5 mm) and pull the terminal block out of the slot.



5. Remove all connection cables from the jacks located on the battery interface module.

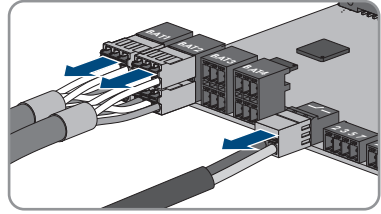

6. Remove all equipment grounding conductors from the equipment grounding terminals. To do this, loosen each screw (TX 25), remove the equipment grounding conductor from the inverter and retighten each screw (TX 25).
7. Remove the network cables from the jacks of the communication assembly.

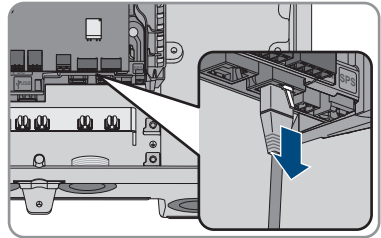

8. Remove all cable glands from the inverter. To do so, unscrew the counter nut from inside and remove the cable gland from the enclosure opening.

9. Seal all enclosure openings with sealing plugs.

10. Remove the 2 screws on the right and left side of the Power Unit (TX25) and retain them for later use. As a result, the Power Unit and the Connection Unit are not connected to one another.

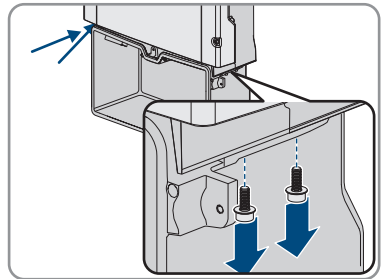

11. Disconnect and remove the Power Unit from the Connection Unit.
12. Unscrew all the screws that are attached to the Connection Unit.
13. Remove the Connection Unit.

## 14. Connect the Connection Unit to the Power Unit.

Make sure that the screw holes on the left and right sides of the Power Unit are directly over those of the Connection Unit; and the cables protruding from the Power Unit must not be pinched.

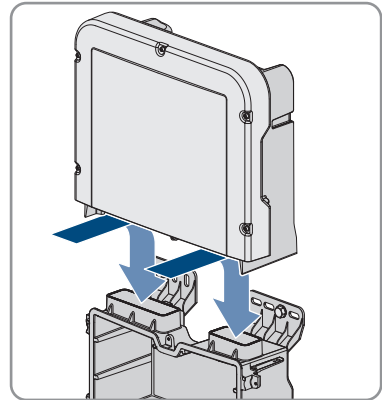
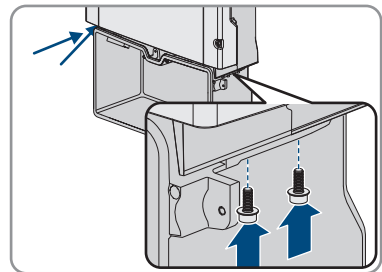
15. Tighten the 2 screws on the right and left side of the Power Unit (TX25) (torque:  $6 \text{ Nm} \pm 0.3 \text{ Nm}$ ).

## 16. Lead the enclosure lid to the Connection Unit and plug the ribbon cable into the socket on the communication assembly.

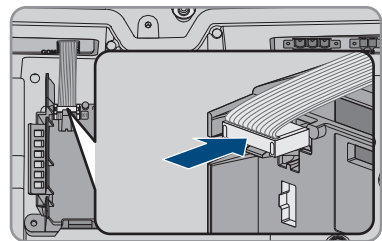

## 17. Ensure that the ribbon cable is securely plugged into the sockets at both ends.

18. Position the enclosure lid of the Connection Unit on the enclosure and tighten all 6 screws crosswise (TX 25, torque:  $3 \text{ Nm} \pm 0.3 \text{ Nm}$ ).

## 19. If the inverter is secured against theft with a padlock, open the padlock and remove it from the inverter.

## 20. If the inverter is to be stored or shipped, pack the inverter. Use the original packaging or packaging that is suitable for the weight and dimensions of the inverter and secure the packaging with tension belts, if necessary.

## 21. Dispose of the inverter in accordance with the locally applicable disposal regulations for electronic waste.

## 13 Procedure for Receiving a Replacement Device

### QUALIFIED PERSON

Under fault conditions, the product may need to be replaced. If this is the case, you will receive a replacement device from SMA Solar Technology AG. If you received a replacement device, replace the defective product with the replacement device as described below.

1. To simplify the configuration of the replacement device, save the configuration data of the defective product to a file (see Section 8.20, page 92).
2. Decommission the defective product (see Section 12, page 136). Remove interfaces and keep them safe for installation into the replacement device (if available).
3. Mount the replacement device and make the electrical connections as described in this document.
4. If needed, install interfaces in the replacement device and connect the interfaces (see the interface manual).

5.

### DANGER

#### **Danger to life due to high voltages**

Once disconnected from voltage sources, residual voltages can remain in the product that should be allowed to discharge completely.

- Wait 10 minutes before opening the upper enclosure lid.

6. If the upper enclosure lid of the replacement device is a transport lid (see information on the enclosure lid), replace the transport lid of the replacement device with the upper enclosure lid of the defective inverter.
  - Unscrew all screws of the upper enclosure lid (TX25) and remove it.
  - Position the upper enclosure lid with the six screws and serrated conical spring washers on the enclosure and tighten it in the specified order (TX25, torque: 6 Nm (53 in)).
7. If the lower enclosure lid of the replacement device is a transport lid (see information on the enclosure lid), replace the transport lid of the replacement device with the lower enclosure lid of the defective inverter.
  - Unscrew all six screws of the lower enclosure lid (TX25) and carefully remove it towards the front. When doing so, note that the LED assembly in the enclosure lid and the communication assembly in the inverter are connected via a ribbon cable.
  - Pull the ribbon cable connecting the LED assembly in the enclosure lid to the communication assembly out of the jack located on the communication assembly.
  - Move the lower enclosure lid to the lower enclosure part. Plug the ribbon cable into the jack on the communication assembly. Ensure that the ribbon cable is firmly plugged into the jacks at both ends.
  - Tighten all six screws of the lower enclosure lid crosswise (TX25, torque: 3 Nm  $\pm$  0.3 Nm).
8. Commission the replacement device (see Section 7.2, page 67).
9. Establish a connection to the user interface (see Section 8.1, page 72).
10. Configure the inverter using the installation assistant.

11. To reuse the saved configuration data of the defective inverter, load it from the respective file (see Section 8.21, page 92).
12. If the defective inverter had been registered by a communication product, replace it with the new product in the communication product.
13. Pack the defective product in the packaging of the replacement device and arrange with SMA Solar Technology AG for it to be picked up.

## 14 Technical Data

### AC terminal

	<b>SBS3.7-10</b>	<b>SBS5.0-10</b>	<b>SBS6.0-10</b>
Rated power at 230 V, 50 Hz	3680 W	5000 W	6000 W
Voltage range <sup>1)</sup>	172.5 V to 264.5 V	172.5 V to 264.5 V	172.5 V to 264.5 V
Nominal grid voltage	230 V	230 V	230 V
Rated current at 220 V	16.7 A	22.7 A	26 A
Rated current at 230 V	16 A	21.7 A	26 A
Rated current at 240 V	15.3 A	20.8 A	25 A
Maximum AC current during battery-backup operation	20 A / 1 min	28 A / 1 min	32 A / 1 min
Total harmonic distortion of the alternating current	< 4 %	< 4 %	< 4 %
Maximum output current under fault conditions	198 A <sub>peak</sub>	198 A <sub>peak</sub>	198 A <sub>peak</sub>
Inrush current	18.5 A	18.5 A	18.5 A
Rated grid frequency	50 Hz	50 Hz	50 Hz
Grid frequency <sup>1)</sup>	50 Hz / 60 Hz	50 Hz	50 Hz / 60 Hz
Operating range at grid frequency 50 Hz	45 Hz to 55 Hz	45 Hz to 55 Hz	45 Hz to 55 Hz
Operating range at grid frequency 60 Hz	55 Hz to 65 Hz	55 Hz to 65 Hz	55 Hz to 65 Hz
Frequency during battery-backup operation (stand-alone grid frequency) <sup>2)</sup>	F <sub>nom</sub> + 2 Hz	F <sub>nom</sub> + 2 Hz	F <sub>nom</sub> + 2 Hz
Short-term frequency during battery-backup operation (stand-alone grid frequency) <sup>2)</sup>	F <sub>nom</sub> + 4 Hz	F <sub>nom</sub> + 4 Hz	F <sub>nom</sub> + 4 Hz

<sup>1)</sup> Depending on the configured country data set

<sup>2)</sup> The stand-alone grid frequency complies with the features of EN 50160:2010.

	SBS3.7-10	SBS5.0-10	SBS6.0-10
Power factor at rated power	1	1	1
Displacement power factor $\cos \varphi$ , adjustable	0.8 overexcited to 1 to 0.8 underexcited	0.8 overexcited to 1 to 0.8 underexcited	0.8 overexcited to 1 to 0.8 underexcited
Feed-in phases	1	1	1
Connection phases	1	1	1
Surge category in accordance with IEC 60664-1	III	III	III

### Battery DC input

	SBS3.7-10	SBS5.0-10	SBS6.0-10
Maximum DC voltage	600 V	600 V	600 V
Voltage range <sup>3)</sup>	100 V to 550 V	100 V to 550 V	100 V to 550 V
Rated DC voltage	360 V	360 V	360 V
Maximum DC current per input	10 A	10 A	10 A
Number of DC inputs	3	3	3
Conditional short-circuit current	40 A	40 A	40 A
Rated short-time withstand current ( $I_{cw}$ )	600 A / <0.01 s	600 A / <0.01 s	600 A / <0.01 s
Unaffected short-circuit current ( $I_{cp}$ )	1500 A / <0.01 s	1500 A / <0.01 s	1500 A / <0.01 s
Battery type <sup>4)</sup>	Li-ion	Li-ion	Li-ion
Surge category in accordance with IEC 60664-1	III	III	III

### AC output, secure power supply operation

Maximum AC power	3680 W
Nominal AC voltage	230 V

<sup>3)</sup> The charging and discharging voltage of the connected batteries must be in the range of 220 V and 500 V in order to make optimum use of the power of the inverter

<sup>4)</sup> Warning! Danger of fire due to use of non-approved batteries. Only use batteries approved by SMA Solar Technology AG (technical information with list of approved batteries at [www.SMA-Solar.com](http://www.SMA-Solar.com)).

Maximum output current	16 A
Minimum load	1 W

### Protective Devices

DC reverse polarity protection	Available
Input-side disconnection point	Not available
AC short-circuit current capability	Current control
Ground fault monitoring	Available
Grid monitoring	SMA Grid Guard 10.0
Maximal output overcurrent protection	40 A
All-pole sensitive residual-current monitoring unit	Available
Active anti-islanding method	Frequency shift

### General data

Width x height x depth	535 mm x 730 mm x 198 mm
Weight	26 kg
Length x width x height of the packaging	600 mm x 800 mm x 300 mm
Weight including packaging	30 kg
Climatic category in accordance with IEC 60721-3-4	4K4H
Environmental category	Outdoors
Pollution degree outside the inverter	3
Pollution degree inside the inverter	2
Operating temperature range	-25 °C to +60 °C
Max. permissible value for relative humidity (condensing)	100 %
Maximum operating altitude above MSL	3000 m
Noise emission, typical	39 dB(A)
Self-consumption in standby mode without the load necessary to supply the battery	< 5 W
Self-consumption without the load necessary to supply the battery	< 10 W
Maximum data volume per inverter with Speedwire/Webconnect	550 MB/month

Additional data volume when using the Sunny Portal live interface	600 kB/hour
Power control / Demand response (DRED)	Communication via Modbus interface
Demand Response Mode	DRM0
Topology	Transformerless (Non-isolated)
Cooling method	Convection
Degree of protection in accordance with IEC 60529	IP65
Protection class in accordance with IEC 62103	I
Radio technology	WLAN 802.11 b/g/n
Radio spectrum	2.4 GHz
Maximum transmission power	100 mW
Quantity maximum detectable Wi-Fi networks	32
Grid configurations	Single-phase

## Climatic Conditions

### Installation in accordance with IEC 60721-3-4, Class 4K4H

Extended temperature range	-25 °C to +60 °C
Extended humidity range	0% to 100%
Extended air pressure range	79.5 kPa to 106 kPa

### Transport in accordance with IEC 60721-3-4, Class 2K3

Extended temperature range	-25 °C to +70 °C
Storage temperature	-40 °C to +60 °C

## Equipment

DC terminal	Spring-cage terminal
AC connection	Spring-cage terminal
Battery communication	CAN bus
Communication for automatic transfer switch	CAN bus
Speedwire interface	As standard
Webconnect function	As standard
Wi-Fi interface	As standard



## Torques

Screw M5x60 for securing the inverter to the wall mounting bracket	1.7 Nm $\pm$ 0.3 Nm
Screws for attaching the enclosure lid of the Connection Unit	3 Nm $\pm$ 0.3 Nm
Screws for grounding on the grounding terminals	6 Nm $\pm$ 0.3 Nm
Screws for <b>AC-out</b> terminal block for AC connection	0.3 Nm
Screws for <b>SPS</b> terminal block for connecting the outlet for secure power supply operation	0.3 Nm

## Data Storage Capacity

Energy yields in the course of the day	63 days
Daily yields	30 years
Event messages for users	1000 events
Event messages for installers	1000 events

## Efficiency

Maximum efficiency, $\eta_{max}$	97.5 %
----------------------------------	--------

## 15 Contact

If you have technical problems with our products, please contact the SMA Service Line. The following data is required in order to provide you with the necessary assistance:

- Battery inverter:
  - Device type
  - Serial number
  - Firmware version
  - Event message
  - Mounting location and mounting height
  - Optional equipment, e.g. communication products
  - Use the name of the system in Sunny Portal (if available)
  - Access data for Sunny Portal (if available)
  - Special country-specific settings (if available)
- Batteries:
  - Type
  - Firmware version
  - Type of automatic transfer switch (if available)

You can find your country's contact information at:



<https://go.sma.de/service>

## 16 EU Declaration of Conformity

within the scope of the EU directives

- Radio Equipment Directive 2014/53/EU (22.5.2014 L 153/62) (RED)
- Restriction of the use of certain hazardous substances 2011/65/EU (L 174/88, June 8, 2011) and 2015/863/EU (L 137/10, March 31, 2015) (RoHS)



SMA Solar Technology AG confirms herewith that the products described in this document are in compliance with the fundamental requirements and other relevant provisions of the above-mentioned directives. The entire EU Declaration of Conformity can be found at [www.SMA-Solar.com](http://www.SMA-Solar.com).

## 17 UK Declaration of Conformity

according to the regulations of England, Wales and Scotland

- Electromagnetic Compatibility Regulations 2016 (SI 2016/1091)
- Electrical Equipment (Safety) Regulations 2016 (SI 2016/1101)
- Radio Equipment Regulations 2017 (SI 2017/1206)
- The Restriction of the Use of Certain Hazardous Substances in Electrical and Electronic Equipment Regulations 2012



SMA Solar Technology AG confirms herewith that the products described in this document are in compliance with the fundamental requirements and other relevant provisions of the above-mentioned regulations. The entire UK Declaration of Conformity can be found at [www.SMA-Solar.com](http://www.SMA-Solar.com).





[www.SMA-Solar.com](http://www.SMA-Solar.com)

