

KeContact

P30

Charging Station Installation manual V 3.32

Translation of the original instructions

KEBA[®]

Automation by innovation.

Document No.: 105786 | Release: 12.2023
Filename: KeContactP30_ihen.pdf
Pages: 66

© KEBA 2017

Specifications are subject to change due to further technical developments. Details presented may be subject to correction.

All rights reserved.

KEBA Energy Automation GmbH

Reindlstraße 51, 4040 Linz, Austria, www.keba.com/emobility
☎ +43 732 7090-0, 🏠 +43 732 7309-10, ✉ kecontact@keba.com

For information about KEBA and our subsidiaries please look at www.keba.com.

Table of contents

1	Introduction.....	5
1.1	Representation of safety instructions.....	5
1.2	Purpose of the document.....	6
1.3	Requirements.....	6
1.4	Intended use.....	6
1.5	Warranty.....	7
1.6	Notes on this document.....	8
1.7	Additional documentation.....	9
2	Safety notes.....	10
3	Scope of delivery.....	12
4	Description of the charging station.....	14
4.1	Front view.....	14
4.2	Rear view.....	15
4.3	Top view.....	15
4.4	Type plate.....	16
4.5	Overview of variants.....	17
4.6	Options.....	19
5	Displays and operating elements.....	20
5.1	LED bar.....	20
5.2	Display (optional).....	20
6	Mounting and installation instructions.....	21
6.1	General criteria for the site selection.....	23
6.2	Space requirements.....	24
6.3	Required tools.....	24
6.4	Mounting the charging station.....	25
7	Connections and wiring.....	28
7.1	Connection overview.....	28
7.2	Required tools.....	29
7.3	Power supply.....	29
7.4	Enable input X1.....	35
7.5	Switch contact output X2.....	36
7.6	Ethernet connection X3 and X4 (optional).....	38
8	Configuration.....	40
8.1	DIP switch settings.....	40

8.2	Prepare mobile network communication (optional).....	44
9	Commissioning.....	46
9.1	Activating/deactivating commissioning mode	46
9.2	Perform safety checks	47
9.3	Mount covers	48
9.4	Attach seal	49
10	Maintenance.....	51
10.1	Replacing the fuse	51
10.2	Troubleshooting	51
10.3	Software update.....	52
10.4	Replace the SIM Card.....	52
11	Disposal.....	53
12	Technical data.....	54
12.1	General	54
12.2	Power supply	54
12.3	Socket / cable	55
12.4	Ambient conditions.....	55
12.5	Interfaces	56
12.6	Optional equipment.....	56
12.7	Calibratable energy meter.....	57
12.8	Further certifications	58
12.9	Dimensions and weight.....	58
13	EU Directives and Standards	60
14	UKCA	61
15	Declaration of conformity	62

1 Introduction

This manual is valid for KeContact P30.

The pictured devices used in this manual are visual examples. The figures and explanations contained in this manual refer to a typical device design. The devices used by you may differ in their appearance.

1.1 Representation of safety instructions

At various points in this manual, you will see notes and precautionary warnings regarding possible hazards. The symbols used have the following meaning:



DANGER!

indicates an imminently hazardous situation, which will result in death or serious bodily injury if the corresponding precautions are not taken.



WARNING!

indicates a potentially hazardous situation, which can result in death or serious bodily injury if the corresponding precautions are not taken.



CAUTION!

means that if the corresponding safety measures are not taken, a potentially hazardous situation can occur that may result in slight bodily injury.

Caution

means that damage to property can occur if the corresponding safety measures are not taken.



ESD

This symbol reminds you of the possible consequences of touching electrostatically sensitive components.

Information

Identifies practical tips and useful information. No information that warns about potentially dangerous or harmful functions is contained.

1.2 Purpose of the document

This document describes the complete installation of KeContact P30.

This document is an extension of the supplied manuals for KeContact P30.

You must comply with all instructions and safety notes in the supplied manuals!

1.3 Requirements

This document contains information for persons with the following requirements:

Target group	Required knowledge and abilities
Electrician	<p>Person who, due to his or her special training, expertise and experience as well as knowledge of current standards, is able to assess the work performed and the possible hazards.</p> <p>Knowledge of:</p> <ul style="list-style-type: none"> • current valid safety information, • the mode of operation of the charging station, • the displays and operating elements of the charging station, • basics of network technology, • diagnostic options, • systematic fault analysis and rectification, • the setting options on the charging station.

1.4 Intended use

The charging station is intended for charging electric vehicles (such as electric cars). The connection of other devices (such as power tools) is not allowed.

The charging station is suitable for indoor and outdoor use. The charging station has to be installed vertically on a wall or on a floor-mounted column. The surface for the installation must be flat and suitably stable (e.g. brick wall, concrete wall). The respective national regulations must be observed with regard to the installation and connection of the charging station.

The intended use of the device always includes the compliance with the environmental conditions for which this device was developed.

The charging station has been developed, manufactured, tested and documented in accordance with the appropriate safety standards. If the instructions and safety instructions described for the intended use are observed, the product will normally not pose a risk to the health of persons or damage to property.

Not observing the safety instructions can result in risk of death, injuries and damage to the device!

The device manufacturer assumes no liability for resulting claims!

1.5 Warranty

Only general maintenance work that is expressly permitted by KEBA may be performed. Any other tampering to the device will result in a loss of the warranty claim.



WARNING!

Risk of electric shock and fire hazard!

After the front part has been opened, product safety can no longer be guaranteed.

Only those covers that are described in the procedure instructions are allowed to be opened. If one of the covers is sealed by a lead seal, it is not permitted to be opened by unauthorized persons. If the lead seal is broken, the device loses its specific suitability for use and may no longer be put into operation due to the resulting incorrect identifier.

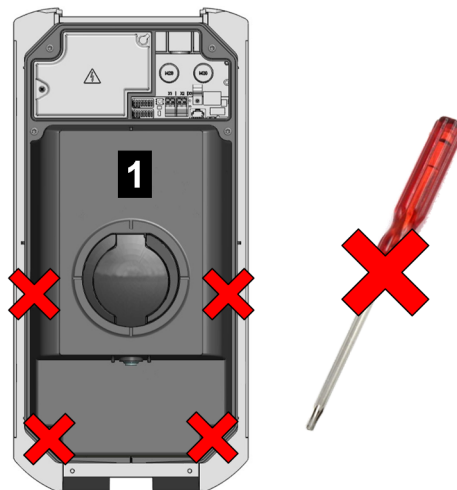

Fig. 1-1: Screws on the front part

The front part **1** must not be opened. Opening the front part (4 Torx screws) will break the manufacturer's seal and void the warranty claim. For a warranty claim, there is a duty of proof of the customer that the defect – which led to the defect of the device – already existed at the time of delivery. If the manufacturer's seal is broken, this proof can no longer be provided, resulting in expiration of the warranty claim.

A device with a broken manufacturer's seal or removed lead seal may no longer be put into operation. The necessary steps must be taken for having the charging station replaced or repaired by a specialist dealer or service partner.

1.6 Notes on this document

The manual is part of the product. It is to be retained over the entire life cycle of the product and should be forwarded to any subsequent owners or users of the product.

The instructions contained in this manual must be followed precisely. Failure to do so could result in the creation of potential sources of danger or the disabling of safety devices. Apart from the safety instructions given in this manual, the safety precautions and accident prevention measures appropriate to the situation in question must also be observed.

1.6.1 Contents of the document

- Description of the charging station
- Assembly of the charging station
- Electrical installation of the charging station
- Commissioning of the charging station
- Maintenance of the charging station

1.6.2 Not contained in this document

- Operation of the charging station
- Troubleshooting

1.7 Additional documentation

Manuals and additional information are available on our website:

www.keba.com/emobility-downloads

Designation	Target group
P30 operating instructions	<ul style="list-style-type: none"> • End customer • Electricians
P30 configuration manual x-series	<ul style="list-style-type: none"> • End customer • Electricians
UDP Programmer's Guide	<ul style="list-style-type: none"> • Programmer
FAQ	<ul style="list-style-type: none"> • End customer • Electricians • Service technicians
Manual for MID variants	<ul style="list-style-type: none"> • Charging infrastructure operating company
Calibratable measurement device for electrical energy in accordance with § 46 of the German Measures and Verification Act (REA No. 6.8)	<ul style="list-style-type: none"> • Charging infrastructure operating company

2 Safety notes



WARNING!

Risk of electric shock and fire hazard!

- Installation, commissioning, maintenance or retrofitting of the charging station must be performed by correctly trained, qualified and authorized electricians¹⁾ who are fully responsible for the compliance with existing standards and installation regulations.

Please observe that an additional overvoltage protection can be required by vehicles or national regulations.

Also note that some countries or vehicle manufacturers may require a different triggering characteristic of the residual current circuit breaker (Type B).

- Do not install or use a damaged device.
 - A damaged charging station must be taken out of commission and repaired or replaced by a qualified and authorized electrician.
 - A repair of the charging station is not permitted and may only be carried out by the manufacturer.
 - No unauthorized conversion work and modifications may be made to the charging station.
 - No markings (such as safety signs, warnings, wire markings, etc.) may be removed from the charging station.
 - Never use faulty, worn-out or dirty charging plugs.
 - Using cable lengthening sets is forbidden.
 - Using adapters of any kind is forbidden.
-

¹⁾ Persons who, due to their special training, expertise and experience as well as knowledge of current standards, are able to assess the work performed and the possible hazards.

Caution**Possible damage to property!**

- When connecting and wiring the charging station, ensure that the connection area is clean so that no foreign objects (pieces of wire, etc.) get inside the charging station.
 - If protective films are present, they may only be removed after connecting the cables.
 - Pull the charging cable out of the plug holder only by the plug and not by the cable.
 - The charging cable must not be damaged mechanically (kinked, pinched or driven over) and the contact area is not allowed to come into contact with sources of heat, dirt or water.
 - Never clean the charging station with aggressive solvents and cleaning agents, abrasive materials, spray water (garden hose, high-pressure cleaner, etc.) or excessive pressure.
-

3 Scope of delivery

The following parts are included in the scope of delivery:

Basic elements

Description	e-series	b-series c-series x-series
Charging station	1x	1x
Cable holder (for versions with charging cable)	1x	1x
Installation and configuration instructions	1x	1x
Operating Instructions	1x	1x
Drilling template	1x	1x
Keys for cylinder lock (optional)	-	3x
RFID card (optional)	-	1x

Installation materials

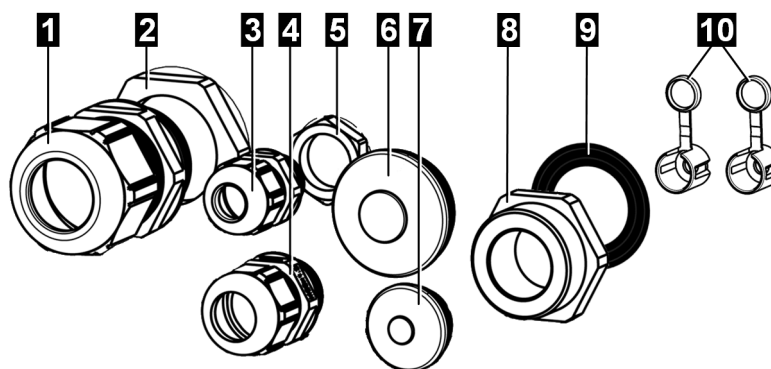

Fig. 3-2: Installation materials

No.	Description	Application	Clamp- ing range	e-series	a-series, b-series, c-series, x-series,
1	Cable gland M32x1.5	Power supply line (top/behind cable installation)	12 – 22 mm	-	1x
2	Locknut M32x1.5		-	1x	1x
3	Cable gland M16x1.5	Data line (top/behind cable installation)	4 – 10 mm	-	1x
4	Cable gland M20	Power supply line (top/behind cable installation), in combination with reduction insert M32/M20 and seal ring	6 – 12 mm	1x	1x

No	Description	Application	Clamp- ing range	e-series	a-series, b-series, c-series, x-series,
5	Locknut M16x1.5		-	-	1x
6	Double-mem- brane seals M32	Power supply line (top/be- hind cable installation)	14 – 21 mm	1x	1x
7	Double-mem- brane seals M20	Data line (top/behind ca- ble installation)	7 – 12 mm	-	1x
8	Reduction insert M32/M20		-	1x	1x
9	Seal ring for re- duction insert	Between reduction insert and housing	-	-	1x
10	Sealing cap	Terminal cover and con- nection panel cover	-	-	2x

Mounting set for wall installation

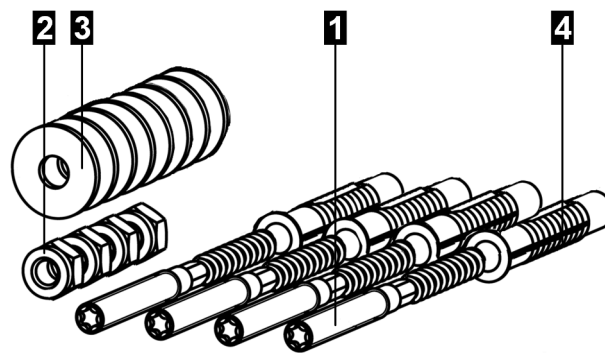

Fig. 3-3: Mounting set for wall installation

No	Description	e-series	b-series c-series x-series
1	Hangar bolts M8x100	-	4x
2	Nut ISO 10511 - M8	-	4x
3	Washer ISO 7089 - 8.4	-	8x
4	Anchors for M10; Fischer UXR-10	-	4x

4 Description of the charging station

4.1 Front view

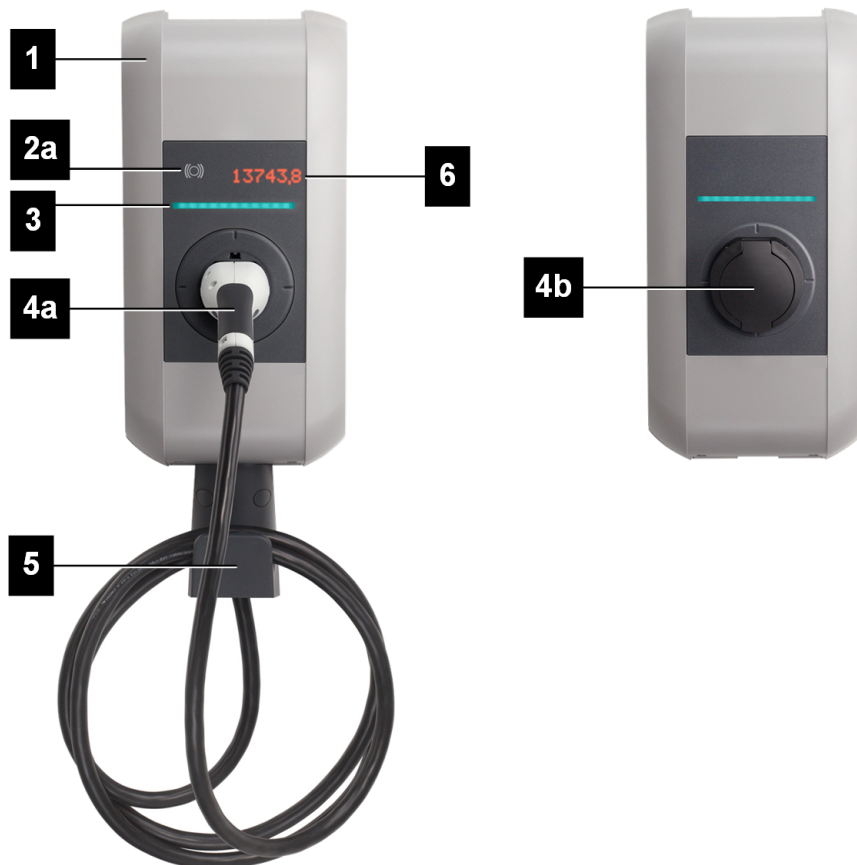

Fig. 4-4: Overview of charging station

1 ... Housing cover	2a ... RFID reader (optional)
3 ... LED bar	4a ... Permanently installed charging cable (optional)
4b ... Charging socket with cover (optional)	5 ... Holder for charging cable (optional)
6 ... Display (optional)	

Information

Depending on the design of the charging station, the charging socket or charging cable may deviate from the shape shown.

4.2 Rear view

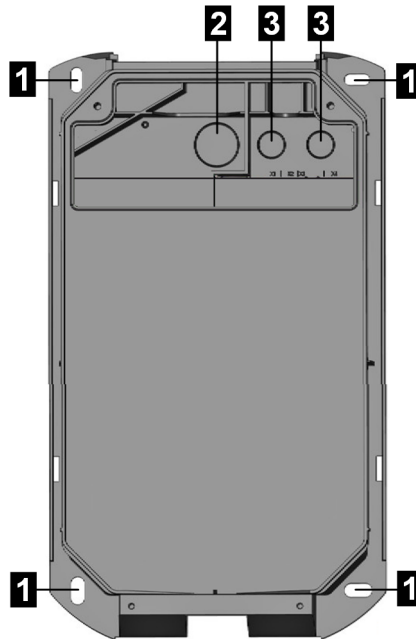

Fig. 4-5: Rear view

1 ... Mounting holes	2 ... Flush-mounting cable insertion openings M32 (for supply line)
3 ... Flush-mounting cable insertion openings M20 (for control line or Ethernet)	

4.3 Top view

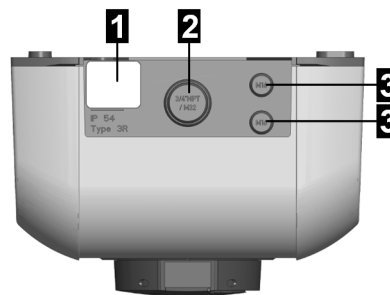

Fig. 4-6: Top view

1 ... Type plate	2 ... Surface-mounting cable insertion openings M32 (for supply line)
3 ... Surface-mounting cable insertion openings M16 (for control line or Ethernet)	

4.4 Type plate

The type plate is located at the top of the charging station.

Information

The type plate shown is an example. The actual data on the type plate depends on the variant.

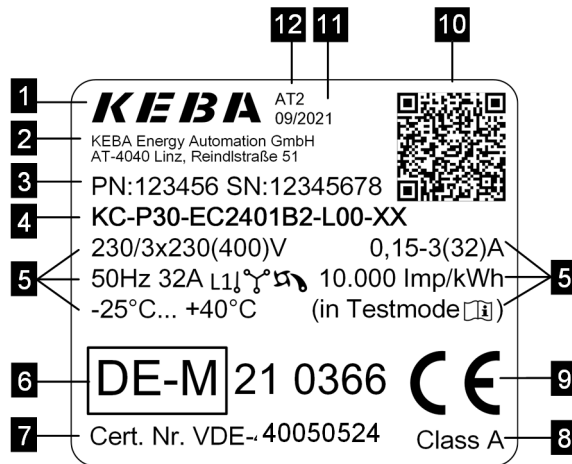

Fig. 4-7: Example type plate

1 ... Manufacturer	2 ... Manufacturer's address
3 ... PN: Material number SN: Serial number	4 ... Product designation
5 ... Technical data	6 ... Marking of the approval
7 ... Type examination number	8 ... Accuracy class in accordance with EN 50470-1, -3
9 ... CE marking of conformity	10 ... Public key information
11 ... Production date	12 ... Production site



Fig. 4-8: Example type plate

1 ... Manufacturer	2 ... Manufacturer's address
--------------------	------------------------------

3 ... Product designation	4 ... Material number
5 ... Technical data	6 ... CE marking of conformity
7 ... MID type examination number	8 ... MID accuracy class
9 ... MID marking	10 ... Serial number
11 ... Production date	12 ... Production site

4.5 Overview of variants

The type and features of the charging station can be determined from the product designation. The product designation is specified on the type plate.

Due to technical or legal restrictions, not all versions/options are available in all countries.

Product designation (example)	KC-P30-	E	C	2	4	00	1	2	-	0	0	R	-xx
Product and series	x												
Country-specific version		x											
Europe IEC		E											
Great Britain / United Kingdom		G											
Cable / Socket			x	x	x								
Socket			S										
Cable			C										
Type 1				1									
Type 2				2									
Shutter				S									
13 A					1								
16 A					2								
20 A					3								
32 A					4								
Cable type						x							
No cable						00							
4 m cable						01							
6 m cable						04							
5,5 m cable						07							
Device series							x						
e-series							0						
b-series							1						
c-series							2						
a-series							3						
x-series WLAN							B						
x-series WLAN, 4G							E						
x-series 4G							H						
x-series 4G, w/o LM							S						

Product designation (example)	KC-P30-	E	C	2	4	00	1	2	-	0	0	R	-xx
x-series WLAN, w/o LM							U						
Switching element								x					
1-phase contactor								1					
3-phase contactor								2					
Energy meter										x			
None										0			
Energy meter, not calibrated										E			
Calibratable energy meter, MID ¹⁾										M			
Calibratable measuring instrument for electrical energy ²⁾ with national approval										L			
X2 functionality											x		
Switch contact output										0			
Authorization												x	
None												0	
RFID, PLC ³⁾												A	
PLC ³⁾												P	
RFID												R	
Customer options													xx

¹⁾ MID (Measuring Instruments Directive): Measuring Instruments Directive

²⁾ In accordance with § 46 of the German Measurement and Verification Act (REA No. 6.8)

³⁾ The ISO 15118 functionalities are not yet available, but the charging stations are prepared for them.

Variants with energy meter

The energy meter measures only the energy that is actually output. The energy for the charging station's internal power supply is not recorded by the energy meter.

Energy meter, not calibrated: Variants with this option may only be used for informative evaluation of energy consumption. Due to the lack of proof of accuracy, these devices must not be used for billing energy.

Calibratable energy meter: Variants with this option are authorized for the measurement of active energy for billing purposes (in accordance with MID 2014/32/EU or specified national regulations). For these devices, there is an identifier of the approval on the type plate. The associated type examination refers to the complete unit. The measurement of the transmitted energy takes place by means of transducers on all phases to be contacted. Supporting documents (e.g. on the test mode) can be requested from KEBA.

Not all variants deriving from the product designation are available with a calibratable energy meter. A list of possible variants is included in the type examination certificate.

Information

There are additional requirements regarding installation and operation for calibratable energy meters. More information on this is available on our website: www.keba.com/emobility-downloads

4.6 Options

This chapter lists the possible options of the charging station.

4.6.1 RFID

The RFID reader is used for the non-contact authorization of a charging process with MIFARE cards or tags according to ISO 14443 and ISO 15693.



Fig. 4-9: RFID

1 ... RFID reader	
--------------------------	--

4.6.2 Mobile network communication (only P30 x-series)

In order to be able to communicate with a higher-level OCPP backend in a charging network, the charging station can optionally be equipped with a mobile network interface.

5 Displays and operating elements

5.1 LED bar



Fig. 5-10: Segments of the LED bar

The LED bar provides visual information about the current operating status of the charging station. It consists of 4 segments (S1 to S4), which can light up or flash, together or individually, in various colors.

The LED bar is only visible with activated power supply.

5.2 Display (optional)

Devices with energy meters (P30 c-series and x-series) have a (dot matrix LED) display.

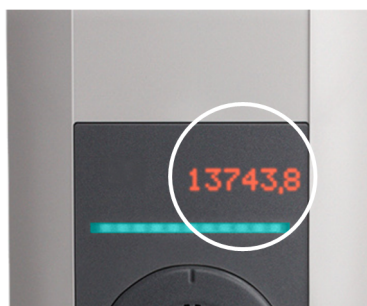

Fig. 5-11: Display

The display may show different information depending on the operating status (e.g., software version, IP address, authorization request). The main task, however, is to display the status of the internal energy meter. The display lights up through the housing and is only visible when the power supply is active.

6 Mounting and installation instructions

The charging station must be installed vertically against a wall or floor-mounted column.

Depending on the scope of delivery, a mounting set for wall mounting is available. The mounting set is suitable for cement, brick and wood (without anchors). For other surfaces, a suitable method of installation must be selected.

Depending on the device model and/or use of special materials, the installation materials must be provided by the customer. Proper installation is absolutely necessary and lies outside of the scope of responsibility of the manufacturer.



WARNING!

Risk of electric shock and fire hazard!

For installation on hollow walls, at least two mounting screws must be secured to a support element of the wall. Special hollow-wall anchors must be used for the other mounting screws. It is particularly important to make sure the substructure has sufficient load-bearing capacity.

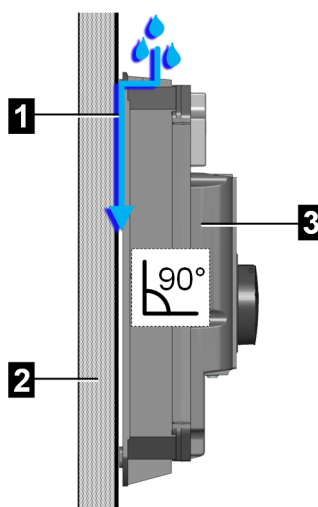

Fig. 6-12: Water drainage

1 ... Water drainage	2 ... Wall or floor-mounted column
3 ... Charging station	

Caution

Property damage due to dampness and moisture!

- The charging station must be installed and commissioned in a suitable environment. The charging station must be protected against rain, snow and dirt during the process. During an outdoor installation, the connection panel cover must not be opened when it is raining, windy, snowing, etc.
- Only a vertical installation of the charging station is permitted. The charging station must be mounted perpendicular to the mounting surface with the supplied washers—no inclination is allowed, otherwise water drainage will not be possible and that will result in damage to the device (see illustration above).
- The joints between the wall/floor-mounted column and the charging station must not be sealed with silicone. Water must be able to drain off behind the charging station (see illustration above). If water drainage is not possible, this will result in damage to the device.
- Do not subject the charging station to high humidity for an extended period of time.
- If a cold charging station is brought into a significantly warmer environment (e.g. after a long transport in a cold environment), condensation may form in the device.
Before connecting the charging station to the power supply, you must wait until the temperature of the charging station is the same as the room temperature and the moisture has evaporated again.
- Installation of the charging station is permitted only against a wall or floor-mounted column. The back side of the charging station has culverts through which condensation can escape to the outside. To ensure that no splash water can get into the device through the culverts, the back side of the charging station must be entirely protected.
- The charging station must always be fully and properly equipped with the supplied cable glands. Unused cable insertion openings must be screwed shut with blind plugs to ensure the necessary leak tightness.

Caution

Risk of breaking the plastic housing!

- Countersunk screws must not be used for the mounting.
 - Four of the supplied washers must be used under the nuts.
 - Do not tighten the mounting screws with force.
 - The mounting surface must be completely flat. Warpage of the housing must be prevented.
 - If adjustment is necessary, the 4 remaining supplied washers must be used.
-

6.1 General criteria for the site selection

The charging station was constructed for the indoor and outdoor area. Accordingly, it is necessary to ensure the correct set-up requirements and the protection of the device at the installation site.

The following criteria must be taken into account when selecting a location:

- Take into account the local electrical installation regulations, fire prevention measures and accident prevention regulations as well as emergency routes at this site.
- The charging station may not be installed in potentially explosive atmospheres (EX environment).
- The charging station may only be installed in stationary applications.
- Mount the charging station so that it is not located in the direct flow of passersby and so that no one can trip over connected charging cables and so that the charging cables do not cover or cross passing pedestrian and motorized traffic.
- Do not install the charging station at locations where it is exposed to ammonia or ammonia gas (e.g. in or at stables).
- The mounting surface must be sufficiently stable in order to withstand the mechanical forces.
- Do not install the charging station at locations where falling objects could damage the device (e.g. hung up ladders or automobile tires).
- The device must not be exposed to direct spray water (e.g. neighboring manual car wash facility, high-pressure cleaner, garden hose).
- The device should be protected against direct rain as far as possible to prevent icing, hail damage or similar.
- If possible, the device should be mounted protected from direct sunlight. Otherwise, (e.g. set up outside at a parking space) the charging current specification will be reduced to 16 A if the maximum permitted temperature is exceeded. The charging process can also subsequently be switched off.
- Observe the permissible environmental conditions (see "Technical data").

Observe the internationally valid installation standards (e.g. IEC 60364-1 and IEC 60364-5-52) and comply with the nationally applicable installation standards and regulations.

6.2 Space requirements

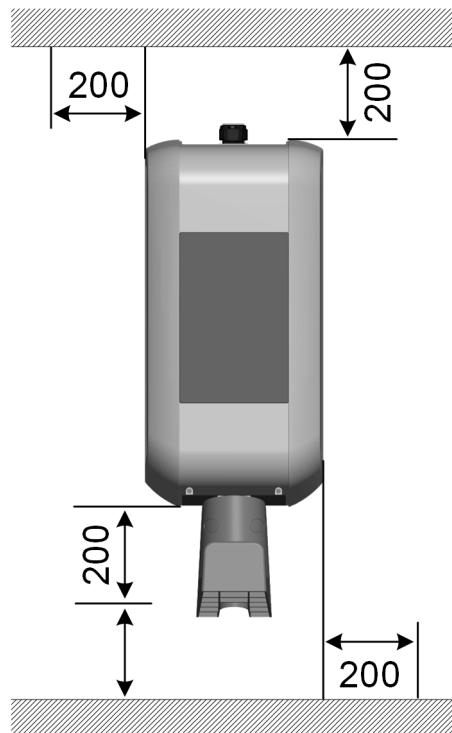

Fig. 6-13: Space requirement, specified in mm

In the case of device variants with optional cable holder, sufficient additional space must be planned for at the bottom for hanging up the charging cable.

If several charging stations are installed adjacent to each other, a distance of at least 200 mm between charging stations must be complied with.

Information

We recommend mounting the charging station (height of the charging socket) at a height of 1.2 m. Observe that national regulations can limit this height.

6.3 Required tools

The following tools are required for the installation:

- Drill suitable for subsurface with diameter 10 mm
- Screwdriver/bit T25
- Socket wrench 13 mm

6.4 Mounting the charging station

The charging station must be prepared for this before mounting. To do this, proceed as follows:

- 1) Unscrew the two screws on the bottom side of the housing cover.

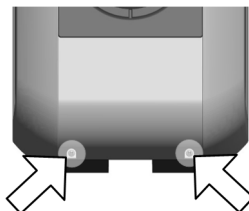

- 2) Lift the housing cover at bottom max. 1 cm (1) and then push upwards (2).



- 3) Loosen the four screws of the connection panel cover and remove the connection panel cover upwards.

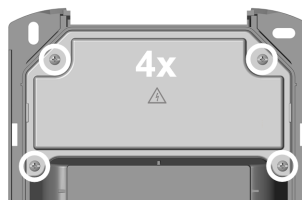

- 4) Loosen the two screws of the terminal cover and remove the terminal cover upwards.

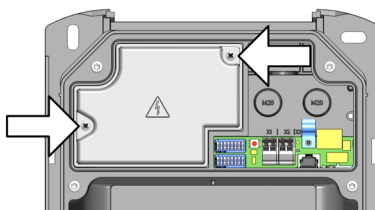

- 5) Place the charging station on a stable surface.
- 6) Using a hammer and flat-head screwdriver, gently knock out the required cable insertion openings (Surface-mounting cable installation: Cable insertion openings on the top side / Flush-mounting cable installation: Cable insertion openings on the back side)

- 7) Insert the cable glands (surface-mounted cable installation) or double-membrane seals (flush-mounted cable installation) into the corresponding cable insertion openings.

The charging station is now ready for installation.

To mount the charging station, proceed as follows:

- 1) Mark the 4 holes (1) in the designated location on the wall. The supplied drilling template can be used for this purpose

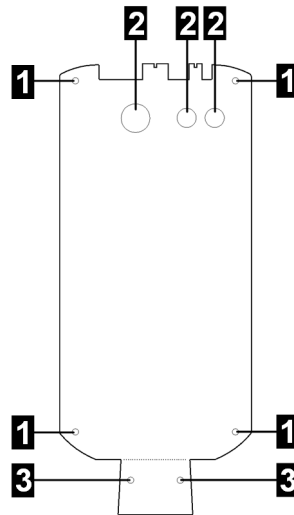
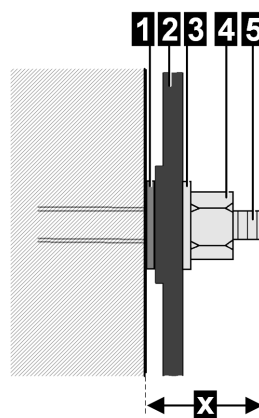

Fig. 6-14: Drilling template

1 ... Mounting holes	2 ... Cable insertion openings
3 ... Cable holder holes	

- 2) If there is a cable holder, mark the cable holder holes (3).
- 3) Drill boreholes and, if necessary, insert anchors in the holes.



1 ... Washer for adjusting	2 ... Rear wall of the charging station
3 ... Washer for nut	4 ... Nut
5 ... Hanger bolt	x ... 20 mm

- 4) Turn the hanger bolts into the hole / anchors until the thread still protrudes approx. 20 mm (X).
- 5) Pull the cable through the prepared openings on the charging station.
- 6) Tighten the cable gland from the back of the charging station. Pay attention to leak tightness!

Information

The cable gland must be tightened before wall mounting, as it is not possible to screw it on afterwards.



Fig. 6-15: Tighten the cable gland from the back

- 7) Insert the supply line so far into the cable gland that the cable sheath is visible in the connection area.
- 8) 4 of the supplied washers can be used to compensate for any unevenness and to ensure proper water flow behind the device: If necessary, place the washers (1) on the hanger bolts.
- 9) Position the charging station on the wall and secure it with the 4 washers (3) and nuts (4) to the hanger bolts (5).

The charging station is now mounted on the wall and ready for cabling.

7 Connections and wiring

7.1 Connection overview

The following illustration shows a connection overview with the covers open.

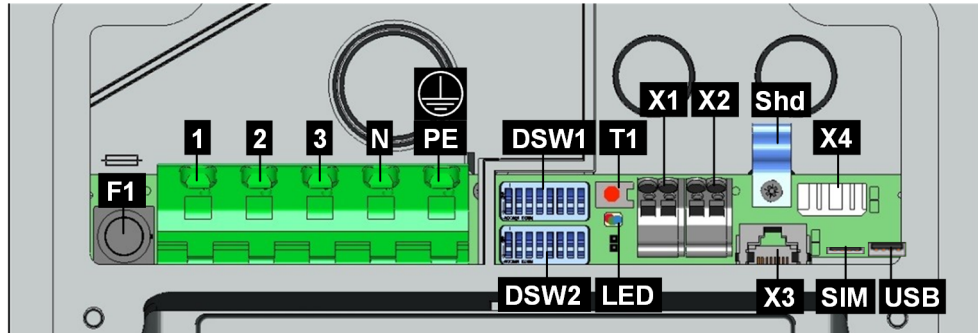

Fig. 7-16: Connection overview

F1 ... Fuse holder	1 ... Power connection phase conductor 1
2 ... Power connection phase conductor 2	3 ... Power connection phase conductor 3
N ... Power connection neutral conductor	PE ... Power connection grounding conductor
DSW1 ... DIP switch	DSW2 ... DIP switch
T1 ... Service button	LED ... Status LED
X1 ... Enable input	X2 ... Switch contact output
Shd ... Shield clamp (ground for ETH)	X3 ... Ethernet2 connection (RJ45)
X4 ... Ethernet1 connection (LSA+® terminals)	SIM ... SIM card slot (optional)
USB ... USB interface	



WARNING!

Risk of electric shock and fire hazard!

- For terminals X[n], only voltages and circuits are permitted to be connected which have a safe separation to dangerous voltages (for example sufficient insulation).
Supply the terminal for the switching contact output (X2) exclusively from voltage sources which have a protective extra-low voltage.
- The fuse on the fuse holder F1 must not be used to switch off the charging station. To interrupt the power supply, always use the circuit line breaker.
- The connection panel is never permitted to be left open unattended. Before leaving the charging station, the connection panel cover must be mounted.

7.2 Required tools

The following tools are required for the electrical installation:

- Flathead screwdriver for supply terminals (blade width 5.5 mm)
- Flathead screwdriver for terminals X[n] (blade width 3.0 mm)
- Phillips head screwdriver PH2
- Mounting tools for cable screw connections M16 (width across flats 20 mm) and M32 (width across flats 36 mm)
- LSA+® insertion tool (optional)

7.3 Power supply

The power supply (supply line) must be hardwired to an existing domestic installation and comply with the applicable national regulations.

Mains disconnecter

The charging station does not have its own power switch. The line circuit breaker of the supply line serves as a mains disconnecter.

Selection of RCD / fault-current circuit breaker

Each charging station must be connected via a separate RCD (Residual Current Device / fault-current circuit breaker). No other consumers may be connected to this circuit.

An RCD with at least Type A must be used since all P30 variants have an internal DC fault current monitoring ≥ 6 mA.

During installation, other important issues such as "cascading" of RCD and selection of a suitable line circuit breaker must be considered.

Dimensioning of the line circuit breaker

When dimensioning the line circuit breaker, the increased ambient temperatures in the control cabinet must also be taken into account! Under certain circumstances, this can make a reduction of the charging current specification necessary in order to increase the system availability.

The nominal current must be determined in accordance with the type plate data in coordination with the desired charging power (DIP switch settings for charging current specification) and the supply line.

$$I_{(\text{DIP switch})} \leq I_{(\text{circuit breaker})} \leq I_{(\text{supply line})} \leq I_{(\text{nominal current})}$$

Dimensioning of the power supply line

When dimensioning the power supply line also observe the possible reduction factors and the increased environmental temperatures inside the connection area of the charging station (see temperature rating of the supply

terminals)! Under certain circumstances, this can lead to an increase of the cable cross-section and to the adaptation of the temperature resistance of the power supply line.

7.3.1 Cable installation

Note the following points during cable installation:

- The surface-mounted cable mounting must always be carried out before the wall installation, as it is not possible to completely screw down the cable gland afterwards.
- The supply line must be sufficiently inserted into the cable gland (surface-mounted cable installation) or the double-membrane seals (flush-mounted cable installation) so that the cable sheath **1** is visible in the connection area. Care must be taken to ensure that the diameter of the cable gland matches the diameter of the cable in order to guarantee tightness.

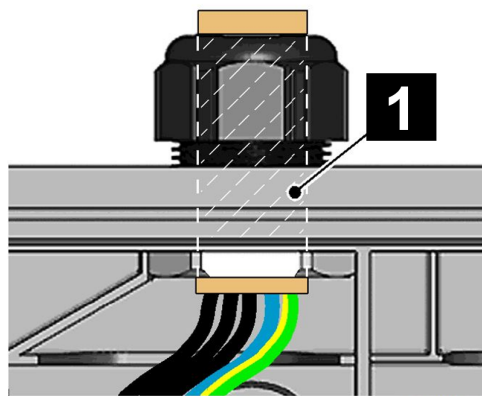

Correct cable gland (surface-mounted cable installation)

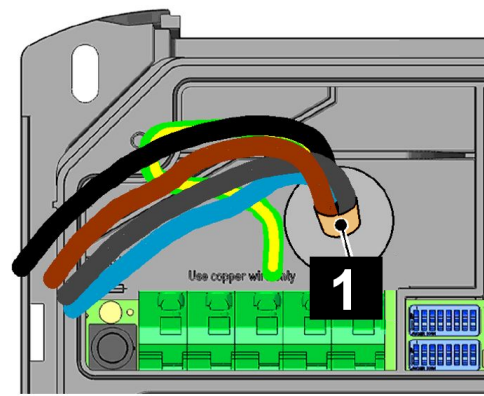

Double-membrane seals (flush-mounted cable installation)

- The double-membrane seals must fit cleanly against the cable sheathing.
- Make sure that the connection cables are inserted centered, straight and without pressure through the double-membrane seals to ensure seal tightness.
- The installation pipe or cable conduit with the feed line may not be screwed together in the cable gland (above) or run through the double-membrane seals (behind).
- The supply line must be routed straight through the cable gland resp. the double-membrane seals in compliance with the bending radii (approx. cable diameter times 10).
- For surface-mounted cable installation, the cable gland must be installed properly and screwed sufficiently tightly from the rear of the charging station, otherwise water may enter.

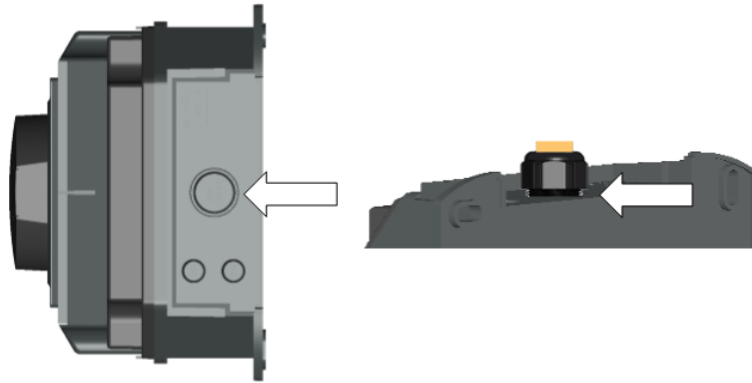

Fig. 7-17: Screwing from the rear

Possible cable glands (surface-mounted)

When using the M32 fitting, no additional sealing ring is necessary, as this fitting already has an integrated sealing ring.

When using a reducing insert (M32->M20), the enclosed sealing rings must be used.

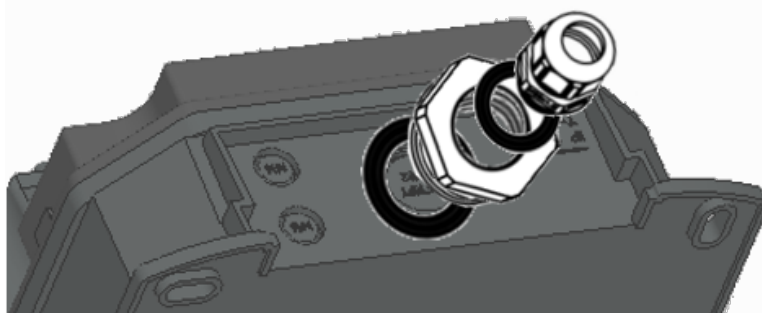
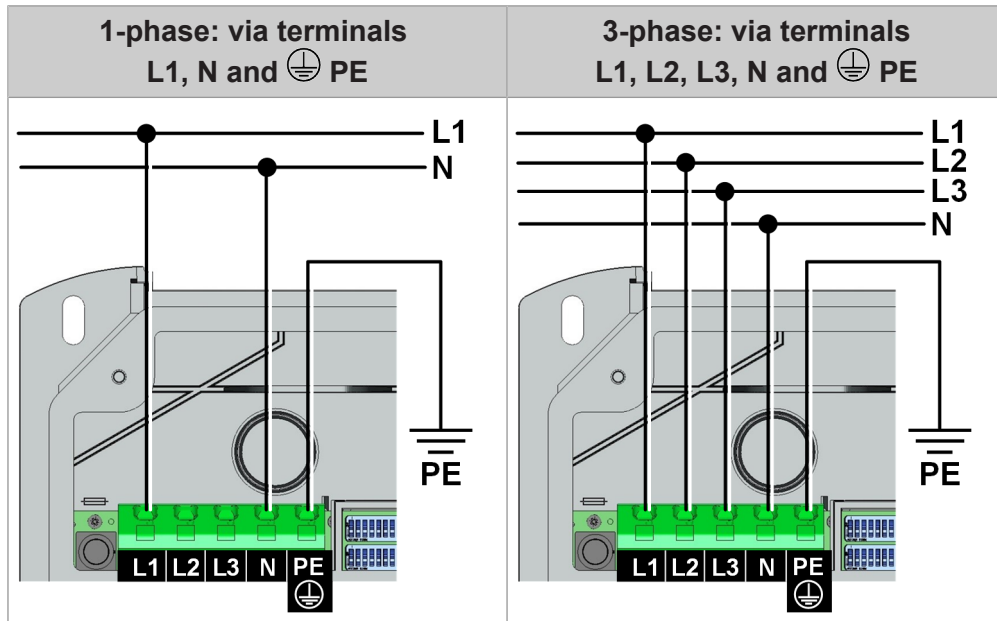

Fig. 7-18: Use of a reducing insert

7.3.2 Connecting the voltage supply

The charging station can be connected in the following ways:



The supply terminals are designed as spring-type terminals. The handling instructions enclosed in the terminal area must be observed.

Caution

Risk of breaking the terminal!

Do not press the screwdriver up, down or to the side!

To connect the supply voltage, proceed as follows:

- 1) Shorten the connection wires to the appropriate length (as short as possible). The protective conductor \oplus PE must be longer than the other conductors!

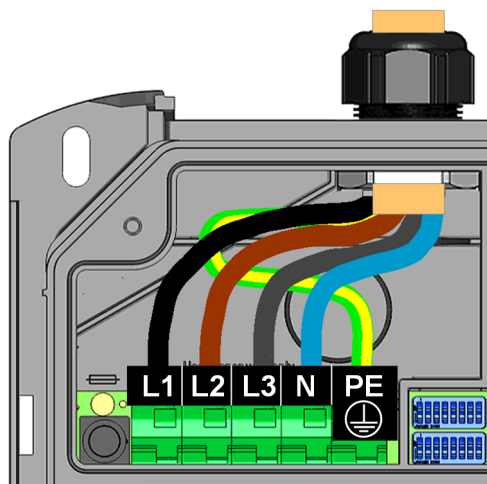

- 2) Strip the connection wires to approx. 12 mm. For stranded wires with fine wires, use wire end sleeves.
- 3) Insert the flat-head screwdriver (5.5 mm) into the supply terminal as shown. The screwdriver must rest on the housing.

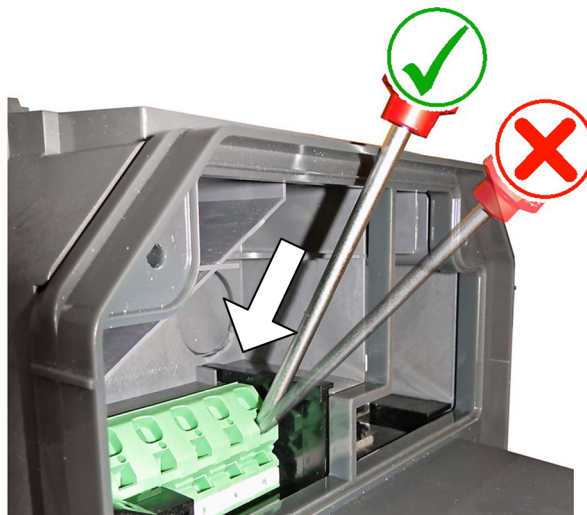

- 4) Press the screwdriver straight into the terminal until the contact opens completely. The angle of the screwdriver changes while pressing in.
- 5) Insert connection wire into the designated terminal opening.

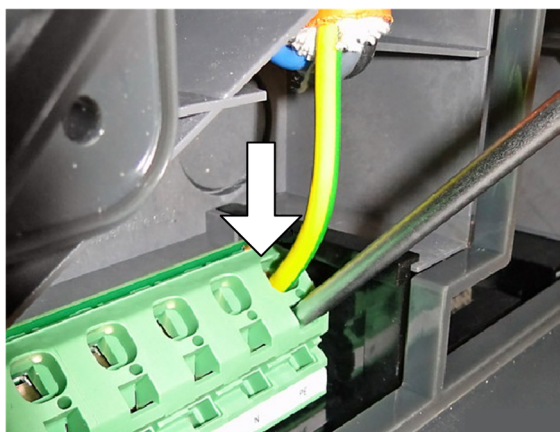

- 6) Pull out the screwdriver straight.
- 7) Repeat these steps for the other connection wires.

The charging station is connected to the power supply.

The charging station is set to 10 A in the delivery state. In order to adapt the maximum current to the installed line circuit breaker, a configuration via the DIP switches is necessary. For details, see [8.1 DIP switch settings](#).

7.3.3 Electrical connection to special systems of AC power supply

Information

The charging station can in principle be connected to TN, TT and IT systems of AC power supply networks. Pay attention to the restrictions of your vehicle manufacturer.

We recommend connecting the charging station in delta networks without upstream transformer only with single phase. A three-phase connection in delta networks should only take place with an upstream transformer ("triangle-to-star converter").

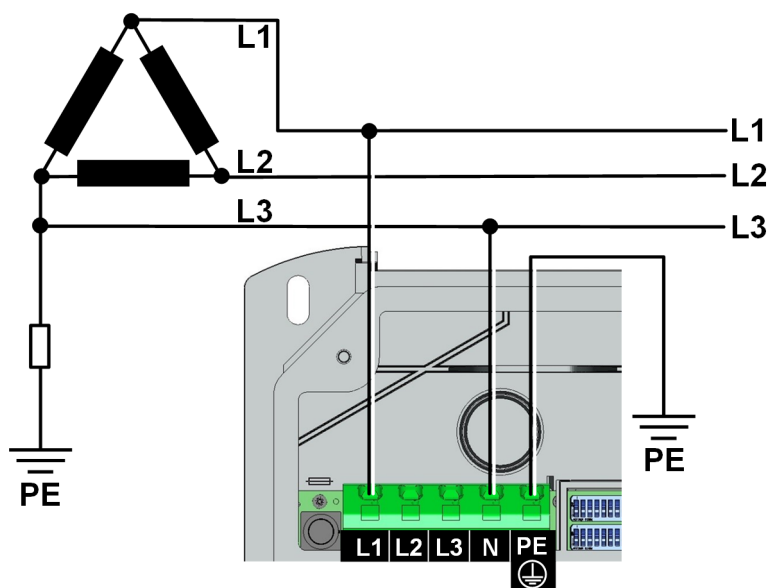

Fig. 7-19: Connection to a three-wire IT system with 230 V

7.4 Enable input X1

This function is not available with P30 e-series.

The enable input X1 is intended for use with a floating contact. Using the enable input, it is possible to control the charging station using external components (e.g. an external key-operated switch, house control, photovoltaic system, ripple control receiver, etc.). The terminal is designed as a spring-type terminal.

Enable contact	State of the charging station
Open	Locked
Closed	Ready for operation

Use of the enable input must be activated with a DIP switch setting (DSW1.1 to ON); see [8.1 DIP switch settings](#).

In addition to the DIP switch setting, starting a charging process using an enable input is dependent on the RFID authorization. The table shows the conditions under which charging is enabled.

RFID	DSW 1.1	Description
Off	OFF	Permanent charging enabled – charging is possible at all times.
Off	ON	Charging enabled when X1 is closed.
On	OFF	P30 a-series, b-series and c-series (without charging network) Charging enabled when X1 is closed OR RFID authorization is correct. The state of X1 is no longer checked during the charging process. The charging process can only be ended early using an RFID card. <i>If no RFID cards have been taught in, charging is possible at all times, whether X1 is open or closed.</i>
On	ON	P30 a-series, b-series and c-series (without charging network) Charging enabled when X1 is closed AND RFID authorization is correct. <i>If no RFID cards have been taught in, charging is enabled when X1 is closed.</i>
On	OFF	P30 c-series (in a charging network) and x-series Charging enabled when RFID authorization is correct. <i>Charging is not possible without an RFID card.</i>
On	ON	P30 c-series (in a charging network) and x-series Charging enabled when X1 is closed AND RFID authorization is correct. <i>Charging is not possible without an RFID card.</i>

7.4.1 Connection diagram

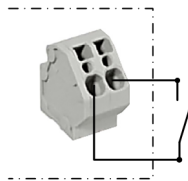

Fig. 7-20: Connection diagram X1

7.5 Switch contact output X2

This function is not available with P30 e-series.

The switch contact output X2 (signal contact) is a floating relay contact and can be used as a charging status display (default use) or contactor monitoring. The terminal is designed as a spring-type terminal.

The use of the switch contact output must be activated with a DIP switch setting (DSW1.2 to ON).

- DSW1.2 OFF means X2 is used as the charge status indicator.
- DSW1.2 ON means X2 is used as contactor monitoring.

For further information see [8.1 DIP switch settings](#).

Charging status display

Switch contact	State of the charging station
Open	Charging station not available. Vehicle is connected, charging station not in operation or faulty.
Closed	Charging station available. Charging station is ready for operation and no vehicle is connected.

Contactor monitoring

Switch contact	State of the charging station
Open	No error.
Closed	A switch contact of the contactor is stuck.

7.5.1 Connection diagram

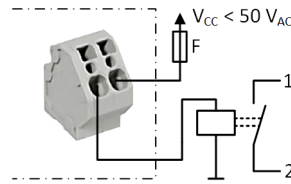
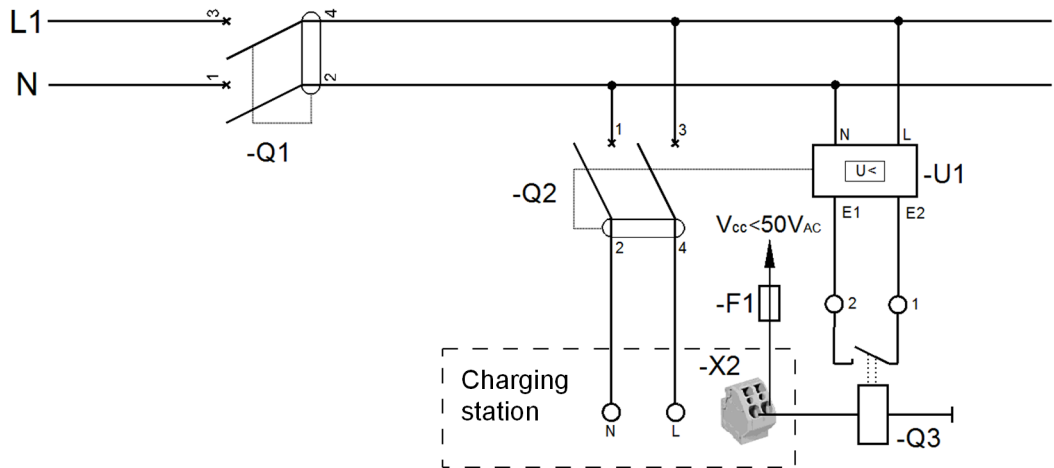

Fig. 7-21: Connection diagram X2

- Safety extra-low voltage $V_{cc} < 50 V_{AC}$
- $F \leq 0.5A$ current-limiting protective equipment

7.5.2 Connection example

The switch contact output can be used to switch off the charging station (disconnect the current) by means of an overriding disconnect solution.



-Q1 ... Main switch	-Q2 ... Line circuit breaker + FI switch
-Q3 ... Contactor/relay	-F1 ... Current-limiting equipment
-U1 ... Undervoltage trigger	-X2 ... Switch contact output

7.6 Ethernet connection X3 and X4 (optional)



WARNING!

Danger from compensation currents on shielding!

Compensation currents flowing through shielding in extended systems can lead to damage to the interfaces and hazards when working on the data lines.

Any measures (such as connecting to a shared distribution board, expanding a TN-S network, etc.) should be discussed with the person responsible for building services.









Information

The Ethernet1 connector X4 (LSA+®) and the Ethernet2 connector X3 (RJ45) are connected in parallel on the PCB and cannot be used at the same time. The unused connection must be disconnected if necessary (e.g. during servicing).

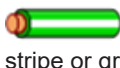
The Ethernet1 connection X4 is designed as a terminal block in LSA+® technology. It is recommended to implement hard-wired communication (e.g. for SmartHome or a charging network) at the LSA+® connection.

Color coding

According to the cabling standards used in the building, the contacts are wired according to **TIA-568A/B** for 100BaseT as follows:

Pin	-568A Pair	-568B Pair	-568A Color	-568B Color
1 (Tx+)	3	2	 white/green stripe	 white/orange stripe
2 (Tx-)	3	2	 green/white stripe or green	 orange/white stripe or orange
3 (Rx+)	2	3	 white/orange stripe	 white/green stripe
4 (Rx-)	2	3	 orange/white stripe or orange	 green/white stripe or green

Terminal data

Category	Wire diameter	Insulation diameter
Inflexible cable Cat 5e / Cat6 STP	0.36 mm (AWG 27)	0.7 – 0.75 mm
	0.4 – 0.64 mm (AWG 26 – AWG 22)	0.7 – 1.4 mm
Cat 6 STP	0.51 – 0.81 mm (AWG 24 – AWG 20)	1.0 – 1.4 mm

Category	Wire diameter	Insulation diameter
Flexible cable Cat 5e / Cat 6 STP	7 x 0.2 mm (AWG 24)	1.1 – 1.4 mm

Preparing the connection cable

To prepare the connection cable, proceed as follows:

- 1) Strip the connection cable about 6 cm.
- 2) Knock back approx. 1 cm of shielding all over and wrap with conductive textile adhesive tape.

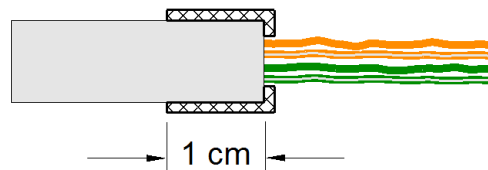

Connecting the cable

To connect the cable, proceed as follows:

- 1) Fix the connecting cable at the point of the wrapped-around shielding braid in the shield clamp **[K]**.
- 2) Tighten the shield clamp.
- 3) Clamp the wires to the terminal block **[ETH]** using an insertion tool.

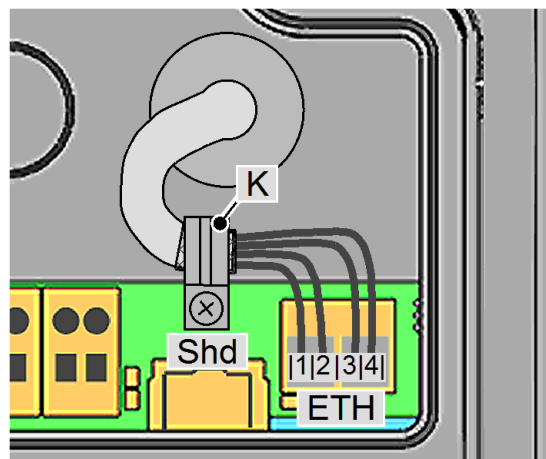

8 Configuration

The basic configuration of the charging station is done using the DIP switches.

8.1 DIP switch settings

Caution

Possible damage to the DIP switches!

The DIP switches are rocker switches and not slider switches. The DIP switches must be pressed and must never be slid.

ON/OFF position of the rocker switches

The illustration shows the position of the rocker switches for the setting ON and OFF

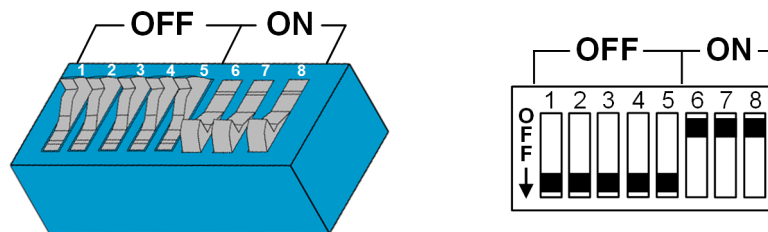

Information



Changes to the DIP switch settings only become effective after a restart of the charging station!

To restart, press the "Service button" until the first beep (approx. 1 second) or switch off the charging station for a short time via the line circuit breaker.

In the following tables, only the affected DIP switches are shown in the illustrations, others are not shown.

Control functions - DSW1

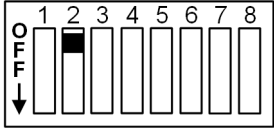
DIP switch	Function	Illustration
DSW1.1	<p>Using the external enable input X1 for starting a charging process.</p> <p>DSW1.1 ON: Charging enabled when X1 is closed. Whether charging is enabled also depends on the RFID authorization. For details, see 7.4 Enable input X1.</p> <p>DSW1.1 OFF: Input X1 is not connected.</p>	

DIP switch	Function	Illustration
DSW1.2	Switching the function of the switching contact output X2. DSW1.2 ON: X2 as contactor monitoring DSW1.2 OFF: X2 as charging status indicator For details, see 7.5 Switch contact output X2 .	
DSW1.3	Activate UDP or Modbus TCP as communication protocol. Only available for P30 c-series and x-series. For details, see "UDP Programmers Guide" or „Modbus TCP Programmers Guide“.	

Avoiding asymmetrical loads - DSW1.4 and DSW1.5

DIP switch	Function	Illustration
DSW1.4 DSW1.5	Only valid for P30 c-series. If communication is activated in the charging network (DSW2.5 = ON) or the wallbox is being operated as a client, this setting is not possible. DSW1.4 = OFF DSW1.5 = OFF = Charging at full power for 1- or 2-phase chargers DSW1.4 = ON DSW1.5 = OFF = value: max. 16A DSW1.4 = OFF DSW1.5 = ON = value: max. 20A	 Example: Symmetric charging, max. 16 A

Setting the amperage - DSW1.6 to DSW1.8

Information

Only one maximum value, which is less than or equal to the operating current according to the type plate, can be set with the DIP switches.

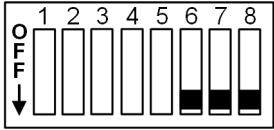
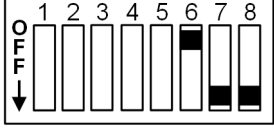
DIP switch	Amperage	Illustration
DSW1.6 DSW1.7 DSW1.8	10 A	
DSW1.6 DSW1.7 DSW1.8	13 A	

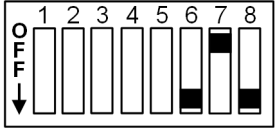
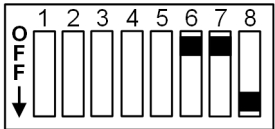
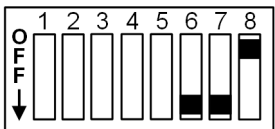
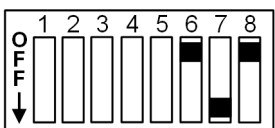
DIP switch	Amperage	Illustration
DSW1.6 DSW1.7 DSW1.8	16 A	
DSW1.6 DSW1.7 DSW1.8	20 A	
DSW1.6 DSW1.7 DSW1.8	25 A	
DSW1.6 DSW1.7 DSW1.8	32 A	

Get IP address via DHCP server - DSW2.1 to DSW2.4

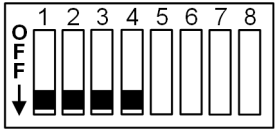
DIP switch	Function	Illustration
DSW2.1 DSW2.2 DSW2.3 DSW2.4	<p>Not valid for P30 x-series.</p> <p>By default, the charging process is carried out independently by the charging station without a higher-level control system.</p> <p>The charging station attempts to obtain an IP address via a DHCP server, if needed. This also corresponds to the basic settings for charging stations without a network connection.</p>	

Setting fixed IP address - DSW2.1 to DSW2.4

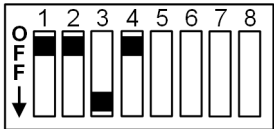
DIP switch	Function	Illustration
<p>DSW2.1 DSW2.2 DSW2.3 DSW2.4</p>	<p>Not valid for P30 x-series.</p> <p>If there are multiple charging stations in a network, the charging stations must be assigned an address.</p> <p>The last two digits of the IP address (192.168.25.xx) can be specified with the DIP switches DSW2.1 to DSW2.4. Each DIP switch has a specific value when it is set to "ON". A DIP switch set to "OFF" has the value 0.</p> <p>DSW2.1 = ON = value: 1 DSW2.2 = ON = value: 2 DSW2.3 = ON = value: 4 DSW2.4 = ON = value: 8</p> <p>The address is obtained by adding the values of the DIP switches and increasing the result by 10: Sum of the DIP switch values + 10 Thus, the addresses 11 to 25 can be set.</p>	 <p>Example of IP address xxx.xxx.xx.21</p> <p>DSW2.1 = ON = 1 DSW2.2 = ON = 2 DSW2.3 = OFF = 0 DSW2.4 = ON = 8</p> <p>Address = 1 + 2 + 0 + 8 + 10 = 21</p>

Activation of communication - DSW2.5

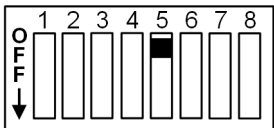
DIP switch	Function	Illustration
<p>DSW2.5</p>	<p>Activation of communication in the charging network.</p> <p>This DIP switch setting must be made for each master and client charging station to enable charging station communication.</p>	

Commissioning mode - DSW2.8

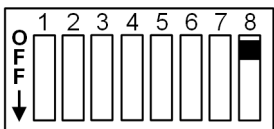
DIP switch	Function	Illustration
<p>DSW2.8</p>	<p>Activate commissioning mode.</p> <p>For details, see 9.1 Activating/deactivating commissioning mode.</p>	

Current limitation using the enable input X1 - DSW2.6

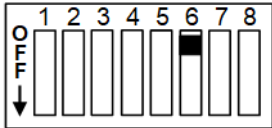
DIP switch	Function	Illustration
DSW2.6	<p>Not valid for P30 e-series.</p> <p>When the enable contact X1 is opened or closed, the available charging current is reduced to a certain value.</p> <p>The enable input X1 must be activated (DSW1.1 = ON).</p> <p>DSW2.6 = OFF = value: 0A DSW2.6 = ON = value: 8A</p>	 <p>Example: Current limitation on, 8A</p>

8.2 Prepare mobile network communication (optional)

Certain device variants feature a mobile network interface. To use the mobile network function, a SIM card must be inserted in the SIM card slot.

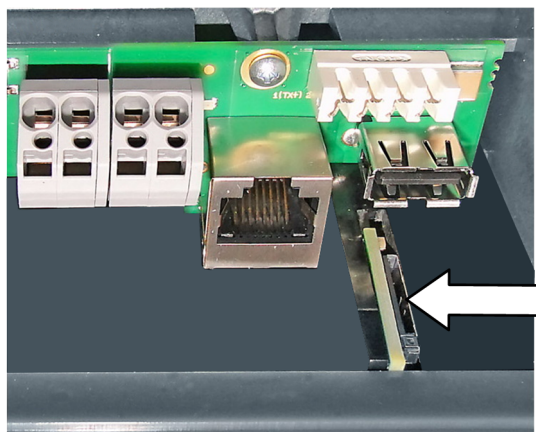

Fig. 8-22: Insertion slot

8.2.1 Inserting the SIM card

Caution

Material damage as a result of soiling!

Ensure that the connector panel remains clean so that no soiling (wire ends, etc.) gets inside the charging station through the SIM card slot.

- 1) If still present, remove the indicated sticker over the SIM card slot.
- 2) Lightly press the SIM card into the card slot until the spring mechanism locks.

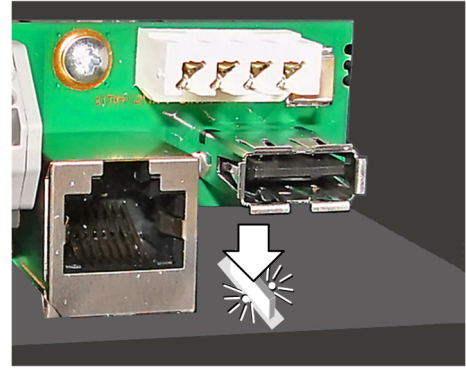
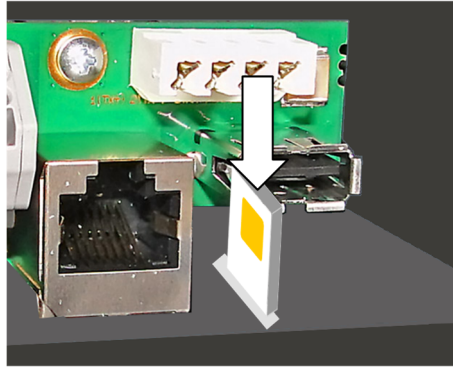

8.2.2 Removing the SIM card

- 1) By lightly pressing the SIM card with your finger, the spring mechanism is activated and the SIM card is ejected.
- 2) Remove the SIM card.

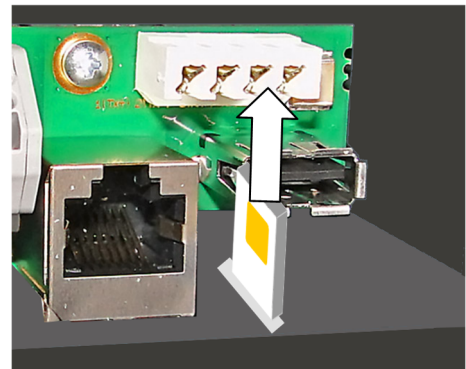
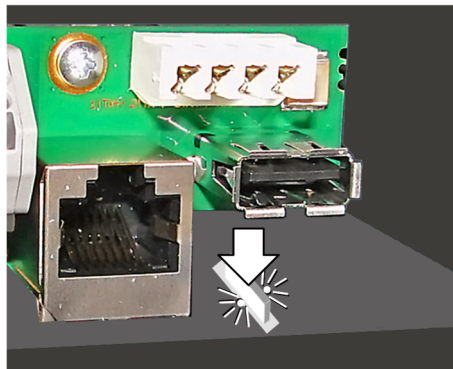

9 Commissioning

The inspections and tests to be performed on the electrical connections and the correct functioning up to the acceptance of the charging station (in accordance with the locally applicable directives and laws) may only be carried out by a qualified electrician.

The following work must be carried out at the start of commissioning:

- Remove all residual installation and connection materials from the connection area.
- Check all screw and clamp connections for tightness.
- Check that all unused cable screw connections are properly sealed with blind plugs or dummy screw fittings.
- Switch on the voltage of the supply line. After 15-20 seconds, the LED bar should flash slowly blue or green. This indicates that the self-test, which is performed automatically at each startup, was successful.

The following steps are necessary during the initial commissioning:

- Activate commissioning mode
- Perform safety checks
- Deactivate commissioning mode
- Mount covers
- Attach seal

9.1 Activating/deactivating commissioning mode

The charging station can be put into a special commissioning mode to help facilitate the system inspection. The device carries out an extended self-test (interlocking, contactor control, current measurement, ...). Furthermore, the contactor is switched on with a time limit, to facilitate initial testing in this mode, even without a vehicle being plugged in. The charging socket is locked to prevent a cable from being plugged in.

A normal charging process is not possible in commissioning mode.

Information

For safety reasons, the commissioning mode is indicated on the charging station by an orange display on segment S3 of the LED bar (-/-orange/-).

Activate commissioning mode

To activate the charging station commissioning mode, proceed as follows:

- 1) Set DIP switch DSW2.8 to ON (see [8.1 DIP switch settings](#)).
- 2) Restart the charging station by pressing the "Service button" until the first beep (approx. 1 second).

Commissioning mode is activated as soon as the LED bar lights up orange. You now have approx. 10 minutes to perform the required inspections and acceptance tests. The contactor is then deactivated and the charging station goes into an error state. This is indicated by the LED bar (white/red/red/red). By restarting via the "Service button", the commissioning mode can be reactivated.

Information

The energy in commissioning mode is taken into account when displaying the total energy. During the commissioning mode, the display is displayed in "watt-hours" (Wh).

Deactivate commissioning mode

In order to be able to operate the charging station properly, the commissioning mode must be deactivated again. To do this, proceed as follows:

- 1) Set DIP switch DSW2.8 to OFF (see [8.1 DIP switch settings](#)).
- 2) Restart the charging station by pressing the "Service button" until the first beep (approx. 1 second).

The charging station starts up again in normal mode and is ready for operation.

9.2 Perform safety checks

Before commissioning, check the effectiveness of the safety measure(s) of the system according to the nationally applicable regulations.

Electrical systems or devices must be checked by the installer of the system or device before commissioning. This also applies for the expansion or modification of existing systems or electrical devices. It is essential that all conditions for the safety measures are observed.

For example, the following points are to be taken into account:

- The checks (continuity of the connections of the protective conductor, insulation resistance, RCD (FI) triggering current, triggering time, etc.) are to be performed.
- The measurement devices must comply with the national regulations!
- The measurement results are to be documented. A test report is to be created and saved before the check.

Information

The tripping characteristics of the internal DC residual current monitoring is based on the product-specific standard IEC 62955. According to this standard, a trigger delay of up to 10 seconds is permitted. This circumstance may result in a negative evaluation for conventional test settings for type B residual current circuit breakers. Here, special test settings are to be used for EVSE (Electric Vehicle Supply Equipment).

9.3 Mount covers

In order to operate the charging station correctly, all covers must be inserted and screwed tight. If necessary, a seal can be attached.

Caution

For correct installation of devices with a calibratable energy meter, the charge point operator must apply a lead seal.

For devices with MID approval, at least the terminal cover must be secured with a lead seal.

For devices with national approval, the connection panel cover must be secured with a lead seal.

To mount all covers, proceed as follows:

- 1) Insert terminal cover and tighten with 2 screws.
If necessary, the right upper screw can be provided with the supplied sealing cap (see [9.4 Attach seal](#)).

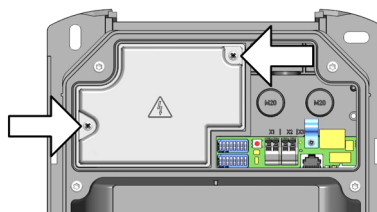

- 2) Insert connection panel cover and tighten with four screws to 2 Nm. The tabs on the connection panel cover must be flush with the enclosing housing. Only then will the device be properly sealed.
If necessary, the right upper screw can be provided with the supplied sealing cap (see [9.4 Attach seal](#)).

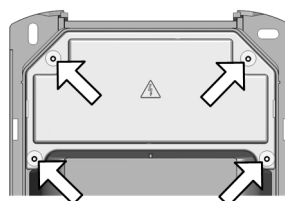

- 3) Hook in the housing cover at the top **1** and close it at the bottom **2**. The housing cover must glide into the guides without considerable resistance. The housing cover must be correctly seated in the housing guide on all sides.

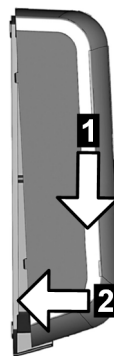
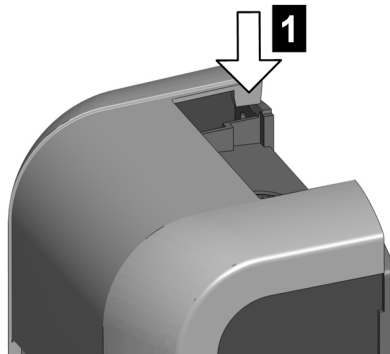

- 4) Secure the housing cover with two screws at the bottom.

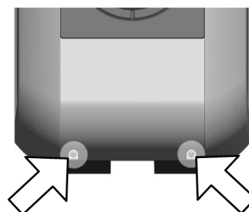

All covers are mounted and the charging station is ready for use.

9.4 Attach seal

Depending on the scope of delivery, devices are available for sealing the terminal cover and the connection panel cover. If required, these can be used to prevent or identify tampering attempts by unauthorized persons at charging stations with preconfiguration or special suitability (MID calibration validity).

To attach the seals, proceed as follows:

- 1) If necessary, open the covers of the charging station until the cover to be sealed is accessible.
- 2) Loosen the right upper screw of the cover to be sealed.

- 3) Insert the screw into the sealing cap.

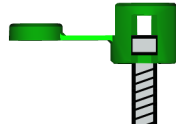

- 4) Screw the screw with the sealing cap back into the cover.
- 5) Close the cover of the sealing cap.



- 6) Thread the sealing wire through the opening of the sealing cap over the screw and place the seal.

The seal is attached. If necessary, reinstall all other covers of the charging station.

10 Maintenance

The hardware of the charging station is basically maintenance-free, but must be checked regularly by the customer or system operator for defects of the charging socket or charging plug (including charging cable) and for damage to the housing (visual inspection).

10.1 Replacing the fuse

Fuse	Current / Voltage	Type	Dimensions
F1	6.3 A / 250 V	Delay with high breaking capacity (>1500A) (T) (H)	5 x 20 mm fuse

To replace the fuse, proceed as follows:

- 1) Switch off the supply voltage of the charging station.
- 2) Remove the housing cover, the connection panel cover, and the terminal cover.
If there is a seal on the connection panel cover or terminal cover, it may only be removed by an authorized person! After changing the fuse, the seal must be replaced.
- 3) Using a screwdriver, press into the opening of the fuse holder.
- 4) Screw the fuse holder counterclockwise until it springs forward automatically by the spring.

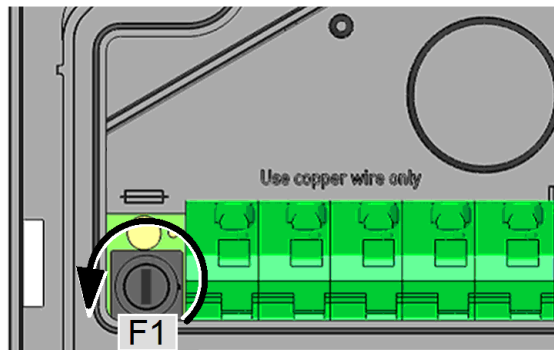

- 5) Replace the fuse.
- 6) Press the fuse holder in and tighten clockwise.
- 7) Mount the housing covers on the charging station again.

The fuse has now been replaced.

10.2 Troubleshooting

Further information (e.g. operating and configuration instructions) and contact details are available on our website:

www.keba.com/emobility-downloads

10.3 Software update

The software of the charging station is subject to the update obligation in accordance with EU directive "Sales of goods 2019/771" and "Digital content 2019/770" and their national versions.

The software of the charging station must therefore always be kept up to date, as it may contain security updates, functional enhancements and bug fixes. A software update is available on our website:

www.keba.com/emobility-downloads

The information and instructions for the current software package from the associated release notes must also be observed.

The instructions for updating the software on P30 via USB or the network connection are contained in the *.zip file. For the P30 x-series, the configuration manual must also be observed.

Information

A software update process on the charging station is indicated by the LED bar slowly flashing orange.

10.4 Replace the SIM Card

To replace the SIM card, proceed as follows:

- 1) Remove the existing SIM card from the card slot (see [8.2.2 Removing the SIM card](#)).
- 2) Insert the new SIM card into the card slot (see [8.2.1 Inserting the SIM card](#)).

11 Disposal

Caution

Please observe the regulations regarding disposal of electric appliances and electronic devices!



- The symbol with the crossed-out waste container means that electrical and electronic devices including their accessories must not be disposed of in the household garbage.
- The materials are recyclable in accordance with their labeling. You can make an important contribution to protecting our environment by reusing, renewing and recycling materials and old appliances.

12 Technical data

12.1 General

Charge mode:	Mode 3 in accordance with IEC 61851-1 AC charging
Overvoltage category:	III in accordance with EN 60664
Protection class:	I
protection type:	IP54
Protection against mechanical impact:	IK10
Rated short-time withstand current:	< 10 kA (effective value in accordance with EN 61439-1)
Residual direct current detecting device (RDC-DD):	> 6 mA (characteristic in accordance with IEC 62955, < 10 s)
Ventilation:	If ventilation is requested by the vehicle, charging will not be started.

12.2 Power supply

Power supply e-series

Rated supply voltage (Europe):	230 V
Internal consumption:	Idling: 2 W, plugged in: 3 W, charging: 5.5 W
Rated current (variant-dependent):	10 A / 13 A / 16 A / 20 A / 25 A / 32 A 1-phase
Line frequency:	50 Hz
Mains forms:	TT / TN / IT

Power supply a-series, , b-series, c-series

Rated supply voltage (Europe):	3 x 230 V / 400 V
Internal consumption:	Idling: 3 W, plugged in: 4.5 W, charging: 6.5 W
Rated current (variant-dependent):	10 A / 13 A / 16 A / 20 A / 25 A / 32 A 1-phase or 3-phase
Line frequency:	50 Hz
Mains forms:	TT / TN / IT

Power supply x-series

Rated supply voltage (Europe):	3 x 230 V / 400 V
Internal consumption:	Idling: 4 W, plugged in: 5 W, charging: 7 W
Rated current (variant-dependent):	10 A / 13 A / 16 A / 20 A / 25 A / 32 A 1-phase or 3-phase
Line frequency:	50 Hz
Mains forms:	TT / TN / IT

Power loss

Socket:	20 W at 22 kW
Cable (4 m):	70 W at 22 kW
Cable (6 m):	100 W at 22 kW

Supply terminals

Type:	Spring-type terminal
Cable feed:	Top (surface), back side (flush)
Connection cross-section of the supply:	Minimum cross-section (depending on the cable and the type of installation)
• 16 A rated current:	5 x 2.5 mm ²
• 32 A nominal current:	5 x 6.0 mm ²
Cross section (cable):	0.2 – 10 mm ²
AWG:	24 – 6
Stripping length:	12 mm
Temperature rating:	105 °C

12.3 Socket / cable

Socket variants:	<ul style="list-style-type: none"> • Type 2 standard socket: 32 A / 400 V AC in accordance with EN 62196-1 and VDE-AR-E 2623-2-2 • Type 2 standard socket: 32 A / 400 V AC in accordance with EN 62196-1 and VDE-AR-E 2623-2-2 with Shutter
Cable versions: (For rating, see type plate on the cable)	<ul style="list-style-type: none"> • Type 1 cable: up to 32 A / 230 V AC in accordance with EN 62196-1 and SAE-J1772 • Type 2 cable: up to 32 A / 400 V AC in accordance with EN 62196-1 and VDE-AR-E 2623-2-2

12.4 Ambient conditions

Use:	Inside and outside area
Access limitations at set-up location:	Limited and unlimited access
Installation (stationary):	On the wall or on a floor-mounted column.
Operating temperature:	
• 16 A:	-25 °C to +50 °C (without direct sunlight)
• 32 A:	-25 °C to +40 °C (without direct sunlight)
Storage temperature:	-25 °C to +80 °C
Relative air humidity:	5 % to 95 % (non condensing)
Altitude:	max. 2000 m above sea level
Rate of temperature change:	max. 0.5 °C / min

Temperature behavior:	Automatic power reduction if overheating occurs
-----------------------	---

12.5 Interfaces

Ethernet interface

Ethernet1:	LSA+® terminals
Data transfer rate:	10/100 Mbit/s
Ethernet2:	RJ45 (for debug)

USB interface

Type:	A, USB 2.0 (Hi-Speed)
Max. output power:	500 mA

Enable input

Type:	External, potential-free switch contact
Type of terminal:	Spring-type terminal
Cross section:	0.08 – 4 mm ²
AWG:	28 – 12
Stripping length:	8 mm

Switch contact output

Type:	External safety extra-low voltage, < 50 V AC (50/60 Hz), ≤ 24 V DC
Required current limitation:	< 0.5 A
Terminal type:	Spring-type terminal
Cross section:	0.08 – 4 mm ²
AWG:	28 – 12
Stripping length:	8 mm

12.6 Optional equipment

4G/LTE mobile network communication

Supported bands:	<p>4G with fallback to 3G/2G</p> <ul style="list-style-type: none"> • LTE (4G) Bands: 1, 3, 8, 20, 28 • UMTS/HSPA+ (3G) Bands: 1, 8 • GSM/GPRS/Edge (2G) Dual-band
------------------	---

Max. data rate:	<p>LTE CAT 1 Download: 10.2 Mbps* Upload: 5.2 Mbps*</p>
-----------------	---

*Depends on external influences

SIM card:	SIM card with 4G authentication Size: Mini-Sim (2FF) Type: Industrial/M2M recommended
-----------	---

RFID card

Type:	MIFARE card / tag according to ISO 14443 or ISO 15693
-------	---

WLAN / Wifi

Type:	IEEE 802.11 b,g,n, 2.4 GHz
Supported modes:	AP Ad-hoc-Mode, Client Mode

12.7 Calibratable energy meter

Meter type:	Electricity meter for active power
Measurement type:	Converter measurement
Non-return device:	Electronic
Minimum current:	0.15 A
Reference current:	3 A
Maximum current:	16 A / 20 A / 32 A
Pulse output in test mode:	10.000 pulses/kWh
Mechanical environmental conditions:	Class M1 (according to MID 2014/32/EU)
Electromagnetic environmental conditions:	Class E2 (according to MID 2014/32/EU)
Limits of the operating temperature for measuring accuracy:	-25 °C to +55 °C
Overflow of the counter:	99.999 kWh

MID

Accuracy class:	Class B (according to EN 50470-1 / -3)
-----------------	--

National approval

Conformity to measurement and calibration standards:	National authorization for auxiliary equipment
Accuracy class:	Class A (according to EN 50470-1 / -3) at the dispensing point
Generation of a measurement data record for each charging session:	<ul style="list-style-type: none"> • Format: OCMF • Energy of the charging session • Customer identification • Signature
Long-term memory for measurement data in the device:	> 20.000 charging sessions
Instant display of the measurement data:	<ul style="list-style-type: none"> • Device-specific display with lighting and dimmer function • Display of the energy of a charging session • Display of the transaction ID

Version with charging cable and holder

Height / Width / Depth: 643 mm / 240 mm / 142 mm

Weight: Approx. 5.3 - 7.8 kg (depending on device version)

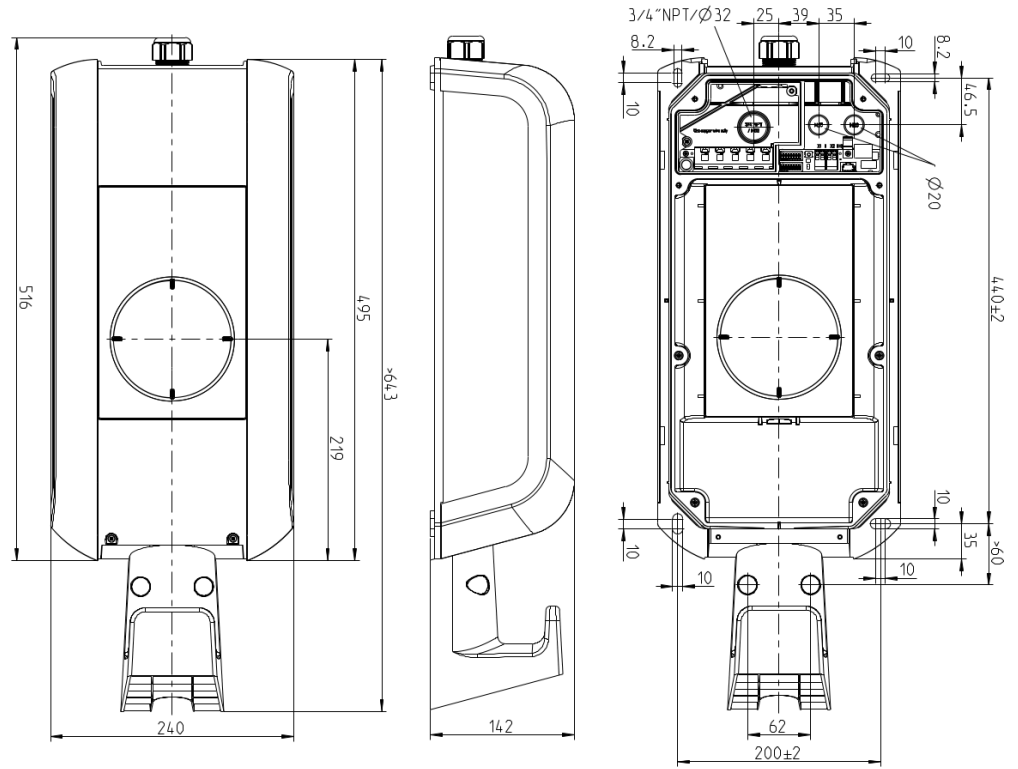

Fig. 12-24: Dimensions in millimeters

13 EU Directives and Standards

2014/35/EU	Low-voltage Directive
2014/30/EU	Electromagnetic Compatibility Directive
2014/53/EU	Radio Equipment Directive (RED)
2011/65/EU	Directive on the restriction of the use of certain hazardous substances (RoHS)
2012/19/EU	Directive for waste electrical and electronic equipment (WEEE)
2014/32/EU	European Measuring Device Directive (MID)

14 UKCA

UKCA (UK Conformity Assessed) is the UK product marking required for certain products placed on the market in the UK (England, Wales and Scotland).

Authorised representative is:

KEBA Ltd.
Aston Court
Frederick Place
Kingsmead Business Park
High Wycombe
HP11 1JU
UK

Authorised representative to compile the technical file is KEBA Ltd.

15 Declaration of conformity



SIMPLIFIED EU DECLARATION OF CONFORMITY

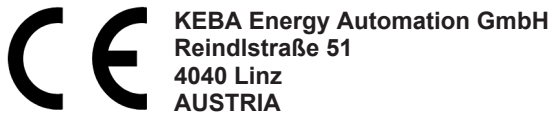

- EN** Hereby, KEBA declares that the radio equipment type model (*1) is in compliance with Directive 2014/53/EU. The full text of the EU declaration of conformity is available at the following internet Address: (*2)
- BG** С настоящото KEBA декларира, че този тип радиосъоръжение (*1) е в съответствие с Директива 2014/53/ЕС. Цялостният текст на ЕС декларацията за съответствие може да се намери на следния интернет адрес: (*2)
- CS** Tímto KEBA prohlašuje, že typ rádiového zařízení (*1) je v souladu se směrnicí 2014/53/EU. Úplné znění EU prohlášení o shodě je k dispozici na této internetové adrese: (*2)
- DA** Hermed erklærer KEBA, at radioudstyrstypen (*1) er i overensstemmelse med direktiv 2014/53/EU. EU-overensstemmelseserklæringens fulde tekst kan findes på følgende internetadresse: (*2)
- DE** Hiermit erklärt KEBA, dass das Gerät mit Funkfunktion (*1) der Richtlinie 2014/53/EU entspricht. Der vollständige Text der EU-Konformitätserklärung ist unter der folgenden Internetadresse verfügbar: (*2)
- EL** Με την παρούσα ο/η KEBA, δηλώνει ότι ο ραδιοεξοπλισμός (*1) πληροί την οδηγία 2014/53/ΕΕ. Το πλήρες κείμενο της δήλωσης συμμόρφωσης ΕΕ διατίθεται στην ακόλουθη ιστοσελίδα στο διαδίκτυο: (*2)
- ES** Por la presente, KEBA declara que el tipo de equipo radioeléctrico (*1) es conforme con la Directiva 2014/53/UE. El texto completo de la declaración UE de conformidad está disponible en la dirección Internet siguiente: (*2)
- ET** Käesolevaga deklareerib KEBA, et käesolev raadioseadme tüüp (*1) vastab direktiivi 2014/53/EL nõuetele. ELi vastavusdeklaratsiooni täielik tekst on kättesaadav järgmisel internetiaadressil: (*2)
- FI** KEBA vakuuttaa, että radiolaitetyypin (*1) on direktiivin 2014/53/EU mukainen. EU-vaatimustenmukaisuusvakuutuksen täysimittainen teksti on saatavilla seuraavassa internetosoitteessa: (*2)
- FR** Le soussigné, KEBA, déclare que l'équipement radioélectrique du type (*1) est conforme à la directive 2014/53/UE. Le texte complet de la déclaration UE de conformité est disponible à l'adresse internet suivante: (*2)
- HR** KEBA ovime izjavljuje da je radijska oprema tipa (*1) u skladu s Direktivom 2014/53/EU. Cjeloviti tekst EU izjave o sukladnosti dostupan je na sljedećoj internetskoj adresi: (*2)
- HU** KEBA igazolja, hogy a (*1) típusú rádióberendezés megfelel a 2014/53/EU irányelvnek. Az EU-megfelelőségi nyilatkozat teljes szövege elérhető a következő internetes címen: 2014.5.22. L 153/104 Az Európai Unió Hivatalos Lapja HU: (*2)
- IT** Il fabbricante, KEBA, dichiara che il tipo di apparecchiatura radio (*1) è conforme alla direttiva 2014/53/UE. Il testo completo della dichiarazione di conformità UE è disponibile al seguente indirizzo Internet: (*2)
- LT** Aš, KEBA AG, patvirtinu, kad radijo įrenginių tipas (*1) atitinka Direktyvą 2014/53/ES. Visas ES atitikties deklaracijos tekstas prieinamas šiuo interneto adresu: (*2)
- LV** Ar šo KEBA deklarē, ka radioiekārta (*1) atbilst Direktīvai 2014/53/ES. Pilns ES atbilstības deklarācijas teksts ir pieejams šādā interneta vietnē: (*2)
- MT** B'dan, KEBA, niddikjara li dan it-tip ta' tagħmir tar-radju (*1) huwa konformi mad-Direttiva 2014/53/UE. It-test kollu tad-dikjarazzjoni ta' konformità tal-UE huwa disponibbli f'dan l-indirizz tal-Internet li ġej: (*2)
- NL** Hierbij verklaar ik, KEBA, dat het type radioapparaat (*1) conform is met Richtlijn 2014/53/EU. De volledige tekst van de EU-conformiteitsverklaring kan worden geraadpleegd op het volgende internetadres: (*2)
- PL** KEBA niniejszym oświadcza, że typ urządzenia radiowego (*1) jest zgodny z dyrektywą 2014/53/UE. Pełny tekst deklaracji zgodności UE jest dostępny pod następującym adresem internetowym: (*2)

- PT** O(a) abaixo assinado(a) KEBA declara que o presente tipo de equipamento de rádio (*1) está em conformidade com a Diretiva 2014/53/UE. O texto integral da declaração de conformidade está disponível no seguinte endereço de Internet: (*2)
- RO** Prin prezenta, KEBA declară că tipul de echipamente radio (*1) este în conformitate cu Directiva 2014/53/UE. Textul integral al declarației UE de conformitate este disponibil la următoarea adresă internet: (*2)
- SK** KEBA týmto vyhlasuje, že rádiové zariadenie typu (*1) je v súlade so smernicou 2014/53/EÚ. Úplné EÚ vyhlásenie o zhode je k dispozícii na tejto internetovej adrese: (*2)
- SL** KEBA potrjuje, da je tip radijske opreme (*1) skladen z Direktivo 2014/53/EU. Celotno besedilo izjave EU o skladnosti je na voljo na naslednjem spletnem naslovu: (*2)
- SV** Härmed försäkrar KEBA att denna typ av radioutrustning (*1) överensstämmer med direktiv 2014/53/EU. Den fullständiga texten till EU-försäkran om överensstämmelse finns på följande webbadress: (*2)

(*1)

Variants												
Form designation system												
Example:	KC-P30-	E	C	2	4	00	1	2-	0	0	R-	xx
	<i>I</i>	<i>II</i>	<i>III</i>	<i>IV</i>	<i>V</i>	<i>VI</i>	<i>VII</i>	<i>VIII</i>	<i>IX</i>	<i>X</i>	<i>XI</i>	<i>XII</i>
<i>I</i>	Basic serie			KC-P30		...Device generation (KeContact-P30)						
<i>II</i>	Basic type			E		...Europe						
						G		...Great Britain / United Kingdom				
<i>III</i>	Interface			S		...Socket outlet						
						C		...Charging cable				
<i>IV</i>	Design of interface			1		...Type 1						
						2		...Type 2 acc. EN 62196-2				
						S		...Type 2 with shutter				
<i>V</i>	Rated current			1		...13 A						
						2		...16 A				
						3		...20 A				
						4		...32 A				
<i>VI</i>	Cable			00		...no cable						
						01		...4 m cable				
						04		...6 m cable				
						07		...5.5 m cable				
<i>VII</i>	Electronics			0		...e-series						
						1		...b-series				
						2		...c-series				
						3		...a-series				
						B		...x-series, WLAN				
						E		...x-series, WLAN, 4G				
						H		...x-series, 4G				
						S		...x-series, WLAN, 4G, w/o LM				
						U		...x-series, WLAN, w/o LM				
<i>VIII</i>	Electrics			1		...1-phase						
						2		...3-phase with smooth residual d.c. detection				

Variants		
<i>IX</i>	Metering	0 ...not equipped E ...Energy meter M ...MID ¹⁾ meter L ...Calibratable electrical energy ²⁾ meter with national approval for additional device
<i>X</i>	X2 functionality	0 ...Switch contact output
<i>XI</i>	Authorisation	0 ...no authorisation A ...RFID, PLC ³⁾ P ...PLC ³⁾ R ...RFID
<i>XII</i>	Customer options	xx ...Options for individual customer versions, not relevant for EU Declaration of Conformity
¹⁾ MID: Measuring Instruments Directive ²⁾ In accordance with Section 46 of the German Measures and Verification Act (Rule Determination Committee (REA) No. 6.8) ³⁾ The ISO 15118 functionalities are not yet available, but the charging stations are prepared for it.		

(*2) www.keba.com/emobility-downloads

KEBA Energy Automation GmbH
Reindlstraße 51
4040 Linz / Austria
www.keba.com

KEBA[®]
Automation by innovation.