



SUNNY TRIPOWER CORE1 (STP 50-40 / STP 50-41)

Important information

Depending on availability, the product is or is not equipped with Wi-Fi functionality. The reason for this is the currently problematic semiconductor supply, caused by the COVID-19 pandemic.

If the product is not equipped with Wi-Fi functionality, please use the standard Ethernet communication interface included for commissioning, configuration and integrating the product into a network.

If integrating the product into a Wi-Fi network is absolutely necessary, this can be done using a commercial Wi-Fi repeater, which is connected to the product via Ethernet.

Without the Wi-Fi function, a direct connection to the user interface by scanning the QR code on the product with the SMA 360° app is not possible. Use a different type of connection.

Legal Provisions

The information contained in these documents is the property of SMA Solar Technology AG. No part of this document may be reproduced, stored in a retrieval system, or transmitted, in any form or by any means, be it electronic, mechanical, photographic, magnetic or otherwise, without the prior written permission of SMA Solar Technology AG. Internal reproduction used solely for the purpose of product evaluation or other proper use is allowed and does not require prior approval.

SMA Solar Technology AG makes no representations or warranties, express or implied, with respect to this documentation or any of the equipment and/or software it may describe, including (with no limitation) any implied warranties of utility, merchantability, or fitness for any particular purpose. All such representations or warranties are expressly disclaimed. Neither SMA Solar Technology AG nor its distributors or dealers shall be liable for any indirect, incidental, or consequential damages under any circumstances.

The exclusion of implied warranties may not apply in all cases under some statutes, and thus the above exclusion may not apply.

Specifications are subject to change without notice. Every attempt has been made to make this document complete, accurate and up-to-date. Readers are cautioned, however, that product improvements and field usage experience may cause SMA Solar Technology AG to make changes to these specifications without advance notice or per contract provisions. SMA Solar Technology AG shall not be responsible for any damages, including indirect, incidental or consequential damages, caused by reliance on the material presented, including, but not limited to, omissions, typographical errors, arithmetical errors or listing errors in the content material.

SMA Warranty

You can download the current warranty conditions from the Internet at www.SMA-Solar.com.

Software licenses

The licenses for the installed software modules (open source) can be found in the user interface of the product.

Trademarks

All trademarks are recognized, even if not explicitly identified as such. Missing designations do not mean that a product or brand is not a registered trademark.

SMA Solar Technology AG

Sonnenallee 1

34266 Niestetal

Germany

Phone +49 561 9522-0

Fax +49 561 9522 100

www.SMA.de

E-mail: info@SMA.de

Status: 3/4/2022

Copyright © 2022 SMA Solar Technology AG. All rights reserved.

Table of Contents

1	Information on this Document	7
1.1	Validity	7
1.2	Target Group	7
1.3	Content and Structure of this Document	7
1.4	Levels of warning messages	7
1.5	Symbols in the Document	8
1.6	Typographical Elements in the Document	8
1.7	Designations in the Document	8
1.8	Additional Information	9
2	Safety	10
2.1	Intended Use	10
2.2	IMPORTANT SAFETY INSTRUCTIONS.....	10
3	Scope of Delivery	16
4	Product Overview	17
4.1	Product Description	17
4.2	Symbols on the Product	18
4.3	Interfaces and Functions	20
4.4	LED Signals.....	24
4.5	Display messages.....	25
4.6	System Overview	26
4.6.1	Circuitry Overview.....	27
4.6.2	Communication Overview	28
5	Mounting.....	29
5.1	Requirements for Mounting	29
5.2	Mounting the product	32
6	Electrical Connection	35
6.1	Overview of the Connection Area	35
6.2	AC Connection.....	35
6.2.1	Requirements for the AC Connection	35
6.2.2	Connecting the Inverter to the Utility Grid	37
6.3	Connecting the Network Cables.....	39
6.4	Connecting the Multifunction Relay	41
6.4.1	Procedure for connecting the multifunction relay	41
6.4.2	Operating Modes of the Multifunction Relay.....	41
6.4.3	Connection Options	42

6.4.4	Connection to the Multifunction Relay	45
6.5	DC Connection.....	47
6.5.1	Requirements for the DC Connection.....	47
6.5.2	Assembling the DC Connectors.....	47
6.5.3	Connecting the PV Array.....	49
6.5.4	Disassembling the DC Connectors	52
7	Commissioning	54
7.1	Commissioning Procedure.....	54
7.2	Commissioning the Inverter.....	55
7.3	Selecting a configuration option	57
8	Operation	60
8.1	Activating and Operating the Display.....	60
8.2	Establishing a connection to the user interface	60
8.2.1	Establishing a Direct Connection via Ethernet	60
8.2.2	Establishing a direct connection via WLAN	60
8.2.3	Establishing a Connection via Ethernet in the local network	63
8.2.4	Establishing a Connection via WLAN in the Local Network	64
8.3	Logging In and Out of the User Interface.....	64
8.4	Start Page Design of the User Interface.....	67
8.5	Displaying and Downloading the Stored Data.....	70
8.6	Activating the Smart Inverter Screen.....	70
8.7	Starting the Installation Assistant.....	70
8.8	Activate WPS Function.....	71
8.9	Switching WLAN On and Off.....	72
8.10	Switching the Dynamic Power Display Off.....	73
8.11	Changing the Password.....	73
8.12	Changing Operating Parameters.....	74
8.13	Configuring the Country Data Set.....	75
8.14	Configuring the Active Power Mode	76
8.15	Configuring Q on Demand 24/7	76
8.16	Changing the Operating Mode of the Multifunction Relay	77
8.17	Configuring the Modbus Function.....	78
8.18	Activating the Receipt of Control Signals (Only for Italy).....	79
8.19	Setting SMA ShadeFix.....	80
8.20	Generating the I-V Characteristic Curve.....	80
8.21	Setting the Rated Residual Current of the Residual-Current Device	81
8.22	Activating or Deactivating the Arc-Fault Circuit Interrupter (AFCI)	81
8.23	Activating and Setting String-Failure Detection	82
8.24	Saving the Configuration in a File.....	84

8.25	Adopting a Configuration from a File.....	84
8.26	Firmware Update	85
8.26.1	Activating Automatic Firmware Update.....	85
8.26.2	Updating Firmware with Update File via the User Interface.....	85
8.26.3	Updating Firmware with Update File via the USB Flash Drive	86
8.26.4	Searching for and Installing New Firmware via the User Interface	87
9	Disconnecting the Inverter from Voltage Sources	88
10	Clean the product	90
11	Troubleshooting.....	91
11.1	Forgotten Password.....	91
11.2	Event Messages	92
11.3	Checking the PV System for Ground Faults.....	107
11.4	Resetting the Operation Inhibition after Detection of an Arc Fault	110
12	Decommissioning the Inverter.....	111
13	Technical Data	115
14	Accessories	119
15	Contact	120
16	EU Declaration of Conformity	121
17	UK Declaration of Conformity.....	122

1 Information on this Document

1.1 Validity

This document is valid for:

- STP 50-40 (Sunny Tripower CORE1) from firmware version $\geq 3.00.00.R$ to 3.11.##.R
- STP 50-41 (Sunny Tripower CORE1) from firmware version $\geq 3.13.00.R$

1.2 Target Group

This document is intended for qualified persons and end users. Only qualified persons are allowed to perform the activities marked in this document with a warning symbol and the caption "Qualified person". Tasks that do not require any particular qualification are not marked and can also be performed by end users. Qualified persons must have the following skills:

- Knowledge of how an inverter works and is operated
- Training in how to deal with the dangers and risks associated with installing, repairing and using electrical devices and installations
- Training in the installation and commissioning of electrical devices and installations
- Knowledge of all applicable laws, standards and directives
- Knowledge of and compliance with this document and all safety information

1.3 Content and Structure of this Document

This document describes the mounting, installation, commissioning, configuration, operation, troubleshooting and decommissioning of the product as well as the operation of the product user interface.

You will find the latest version of this document and further information on the product in PDF format and as eManual at www.SMA-Solar.com. You can also call up the eManual via the user interface of the product.

Illustrations in this document are reduced to the essential information and may deviate from the real product.

1.4 Levels of warning messages

The following levels of warning messages may occur when handling the product.

DANGER

Indicates a hazardous situation which, if not avoided, will result in death or serious injury.

WARNING

Indicates a hazardous situation which, if not avoided, could result in death or serious injury.





CAUTION

Indicates a hazardous situation which, if not avoided, could result in minor or moderate injury.

NOTICE

Indicates a situation which, if not avoided, can result in property damage.

1.5 Symbols in the Document

Icon	Explanation
	Information that is important for a specific topic or goal, but is not safety-relevant
<input type="checkbox"/>	Indicates a requirement for meeting a specific goal
<input checked="" type="checkbox"/>	Desired result
	A problem that might occur.
	Example
	Sections describing activities to be performed by qualified persons only

1.6 Typographical Elements in the Document

Typographical element	Use	Example
bold	<ul style="list-style-type: none"> Messages Terminals Elements on a user interface Elements to be selected Elements to be entered 	<ul style="list-style-type: none"> Connect the insulated conductors to the terminals X703:1 to X703:6. Enter 10 in the field Minutes.
>	<ul style="list-style-type: none"> Connects several elements to be selected 	<ul style="list-style-type: none"> Go to Settings > Date.
[Button] [Key]	<ul style="list-style-type: none"> Button or key to be clicked on or pressed down 	<ul style="list-style-type: none"> Select [Enter].
#	<ul style="list-style-type: none"> Placeholder for variable components (e.g., parameter names) 	<ul style="list-style-type: none"> Parameter WClHz.Hz#

1.7 Designations in the Document

Complete designation	Designation in this document
Sunny Tripower CORE1	Inverter, product

1.8 Additional Information

For more information, please go to www.SMA-Solar.com.

Title and information content	Type of information
"PUBLIC CYBER SECURITY - Guidelines for a Secure PV System Communication"	Technical Information
"SMA GRID GUARD 10.0 - Grid Management Services via Inverter and System Controller"	Technical Information
"Simplified implementation of the network and system protection in PV systems"	Technical Information
"Efficiency and Derating" Efficiency and derating behavior of the SMA inverters	Technical Information
"Short-Circuit Currents" Information on short-circuit currents of SMA PV inverters	Technical Information
"Parameters and Measured Values" Overview of all inverter operating parameters and their configuration options	Technical Information
"SMA and SunSpec Modbus® Interface" Information on the Modbus interface	Technical Information
"Modbus® parameters and measured values" Device-specific list of the Modbus register	Technical Information
"Integrated Plant Control" Detailed explanation of the function and description for setting the function	Technical Information
"Arc-fault circuit interrupter in the Sunny Tripower Core1 (STP 50-41)"	Technical Information
"SMA SPEEDWIRE FIELDBUS"	Technical information
"Temperature Derating"	Technical Information
"I-V diagnostic function: Determination of the generator characteristic curve by the inverter for fault detection in the PV array"	Technical Information

2 Safety

2.1 Intended Use

The Sunny Tripower is a transformerless PV inverter, with 6 MPP trackers, that converts the direct current of the PV array to grid-compliant, three-phase current and feeds it into the utility grid.

The product is intended for use in industrial environments.

The product complies with EN 55011 of class A, group 1:

The product is not intended to be used in living areas and cannot provide protection of radio reception against interference signals in such environments.

The product is suitable for indoor and outdoor use.

The product must only be operated with PV modules of protection class II in accordance with IEC 61730, application class A. The PV modules must be compatible with this product.

The product is not equipped with an integrated transformer and therefore has no galvanic isolation. The product must not be operated with PV modules whose outputs are grounded. This can cause the product to be destroyed. The product may be operated with PV modules whose frame is grounded.

PV modules with a high capacity to ground must only be used if the coupling capacity of all PV modules does not exceed 12.6 μF (for information on how to determine the coupling capacity, see the Technical Information "Leading Leakage Currents" at www.SMA-Solar.com).

All components must remain within their permitted operating ranges and their installation requirements at all times.

The product must only be used in countries for which it is approved or released by SMA Solar Technology AG and the grid operator.

Use SMA products only in accordance with the information provided in the enclosed documentation and with the locally applicable laws, regulations, standards and directives. Any other application may cause personal injury or property damage.

Alterations to the SMA products, e.g., changes or modifications, are only permitted with the express written permission of SMA Solar Technology AG. Unauthorized alterations will void guarantee and warranty claims and in most cases terminate the operating license. SMA Solar Technology AG shall not be held liable for any damage caused by such changes.

Any use of the product other than that described in the Intended Use section does not qualify as appropriate.

The enclosed documentation is an integral part of this product. Keep the documentation in a convenient, dry place for future reference and observe all instructions contained therein.

This document does not replace any regional, state, provincial, federal or national laws, regulations or standards that apply to the installation, electrical safety and use of the product. SMA Solar Technology AG assumes no responsibility for the compliance or non-compliance with such laws or codes in connection with the installation of the product.

The type label must remain permanently attached to the product.

2.2 IMPORTANT SAFETY INSTRUCTIONS

Keep the manual for future reference.

This section contains safety information that must be observed at all times when working.

The product has been designed and tested in accordance with international safety requirements. As with all electrical or electronic devices, there are residual risks despite careful construction. To prevent personal injury and property damage and to ensure long-term operation of the product, read this section carefully and observe all safety information at all times.

 **DANGER**

Danger to life due to electric shock when live components or DC cables are touched

When exposed to light, the PV modules generate high DC voltage which is present in the DC cables. Touching live DC cables results in death or lethal injuries due to electric shock.

- Do not touch non-insulated parts or cables.
- Disconnect the product from voltage sources and ensure it cannot be reconnected before working on the device.
- Do not disconnect the DC connectors under load.
- Wear suitable personal protective equipment for all work on the product.

 **DANGER**

Danger to life due to electric shock from touching an ungrounded PV module or array frame

Touching ungrounded PV modules or array frames results in death or lethal injuries due to electric shock.

- Connect and ground the frame of the PV modules, the array frame and the electrically conductive surfaces so that there is continuous conduction. Observe the applicable local regulations.

 **DANGER**

Danger to life due to electric shock when touching live system components in case of a ground fault

If a ground fault occurs, parts of the system may still be live. Touching live parts and cables results in death or lethal injuries due to electric shock.

- Disconnect the product from voltage sources and ensure it cannot be reconnected before working on the device.
- Only touch the cables of the PV modules on their insulation.
- Do not touch any parts of the substructure or frame of the PV array.
- Do not connect PV strings with ground faults to the inverter.

DANGER

Danger to life due to electric shock in case of overvoltages and if surge protection is missing

Overvoltages (e. g. in the event of a flash of lightning) can be further conducted into the building and to other connected devices in the same network via the network cables or other data cables if there is no surge protection. Touching live parts and cables results in death or lethal injuries due to electric shock.

- Ensure that all devices in the same network are integrated in the existing overvoltage protection.
- When laying the network cable outdoors, ensure that there is suitable surge protection at the network cable transition from the product outdoors to the network inside the building.
- The Ethernet interface of the product is classified as "TNV-1" and offers protection against overvoltages of up to 1.5 kV.

WARNING

Danger to life due to fire and explosion

In rare cases, an explosive gas mixture can be generated inside the product under fault conditions. In this state, switching operations can cause a fire inside the product or explosion. Death or lethal injuries due to hot or flying debris can result.

- In the event of a fault, do not perform any direct actions on the product.
- Ensure that unauthorized persons have no access to the product.
- Do not operate the DC load-break switch on the inverter in case of an error.
- Disconnect the PV array from the inverter via an external disconnection device. If there is no disconnecting device present, wait until no more DC power is applied to the inverter.
- Disconnect the AC circuit breaker, or keep it disconnected in case it has already tripped, and secure it against reconnection.
- Only perform work on the product (e.g., troubleshooting, repair work) when wearing personal protective equipment for handling of hazardous substances (e.g., safety gloves, eye and face protection, respiratory protection).

WARNING

Risk of injury due to toxic substances, gases and dusts.

In rare cases, damages to electronic components can result in the formation of toxic substances, gases or dusts inside the product. Touching toxic substances and inhaling toxic gases and dusts can cause skin irritation, burns or poisoning, trouble breathing and nausea.

- Only perform work on the product (e.g., troubleshooting, repair work) when wearing personal protective equipment for handling of hazardous substances (e.g., safety gloves, eye and face protection, respiratory protection).
- Ensure that unauthorized persons have no access to the product.

⚠ WARNING**Danger to life due to electric shock from destruction of the measuring device due to overvoltage**

Overvoltage can damage a measuring device and result in voltage being present in the enclosure of the measuring device. Touching the live enclosure of the measuring device results in death or lethal injuries due to electric shock.

- Only use measuring devices with a DC input voltage range of 1000 V or higher.

⚠ CAUTION**Risk of burns due to hot enclosure parts**

The enclosure and the enclosure lid may get hot during operation. The DC load-break switch can not become hot.

- Do not touch hot surfaces.
- Wait until the inverter has cooled down before touching the enclosure or enclosure lid.

⚠ CAUTION**Risk of injury due to weight of product**

Injuries may result if the product is lifted incorrectly or dropped while being transported or mounted.

- Carry and lift the product upright with the help of several people. Take the weight and the center of gravity of the product into account. The center of gravity is on the side of the AC-Connection Unit.
- Wear suitable personal protective equipment for all work on the product.
- Transport the product using the carrying handles or hoist. Take the weight of the product into account.
- Use all carrying handles provided during transport with carrying handles.
- Do not use the carrying handles as attachment points for hoist equipment (e.g. straps, ropes, chains). Insert eye bolts into threads provided on top of the product to attach the hoist system.

NOTICE**Damage to the enclosure seal in subfreezing conditions**

If you open the product when temperatures are below freezing, the enclosure seals can be damaged. Moisture can penetrate the product and damage it.

- Only open the product if the ambient temperature is not below -5°C .
- If a layer of ice has formed on the enclosure seal when temperatures are below freezing, remove it prior to opening the product (e.g. by melting the ice with warm air).

NOTICE**Damage to the product due to sand, dust and moisture ingress**

Sand, dust and moisture penetration can damage the product and impair its functionality.

- Only open the product if the humidity is within the thresholds and the environment is free of sand and dust.
- Do not open the product during a dust storm or precipitation.
- Close tightly all enclosure openings.

NOTICE**Damage to the inverter due to electrostatic discharge**

Touching electronic components can cause damage to or destroy the inverter through electrostatic discharge.

- Ground yourself before touching any component.

NOTICE**High costs due to inappropriate Internet tariff**

Depending on use, the data volume of the product transferred via the Internet may vary in size. The data volume depends, for example, on the number of devices in the system, the frequency of device updates, the frequency of data transfer to Sunny Portal or the use of FTP push. High costs for the Internet connection can be the result.

- SMA Solar Technology AG recommends using an Internet flat rate.

NOTICE**Damage to the product due to cleaning agents**

The use of cleaning agents may cause damage to the product and its components.

- Clean the product and all its components only with a cloth moistened with clear water.

i **Change to the names and units of grid parameters to comply with the grid-connection requirements in accordance with Regulation (EU) 2016/631 (valid from April 27, 2019)**

To comply with the EU grid-connection requirements (valid from April 27, 2019) the names and units of grid parameters were changed. This change is valid from firmware version $\geq 3.00.00.R$ if a country data set for fulfilling the EU grid-connection requirements (valid from 2019-04-27) is set. Names and units of grid parameters for inverters with firmware version $\leq 2.99.99.R$ are not affected by this change and remain valid. This also applies from firmware version $\geq 3.00.00.R$ if a country data set that is valid for countries outside the EU is set.

i A country data set must be set for feed-in operation

From firmware version 3.13.##.R, the activation conditions for feed-in operation were changed.

To ensure the inverter begins feed-in operation during initial commissioning, a country data set must be set (for instance via the installation assistant on the user interface of the product, or via a communication product).

If no country data set is set, then feed-in operation will be stopped. This state is signaled by the green and red LEDs flashing simultaneously.

The inverter will automatically start feed-in operation only after the inverter configuration is completed.

i The country data set must be set correctly.

If you select a country data set which is not valid for your country and purpose, it can cause a disturbance in the PV system and lead to problems with the grid operator. When selecting the country data set, you must always observe the locally applicable standards and directives as well as the properties of the PV system (e.g. PV system size, grid-connection point).

- If you are not sure which standards and directives are valid for your country or purpose, contact the grid operator.

3 Scope of Delivery

Check the scope of delivery for completeness and any externally visible damage. Contact your distributor if the scope of delivery is incomplete or damaged.

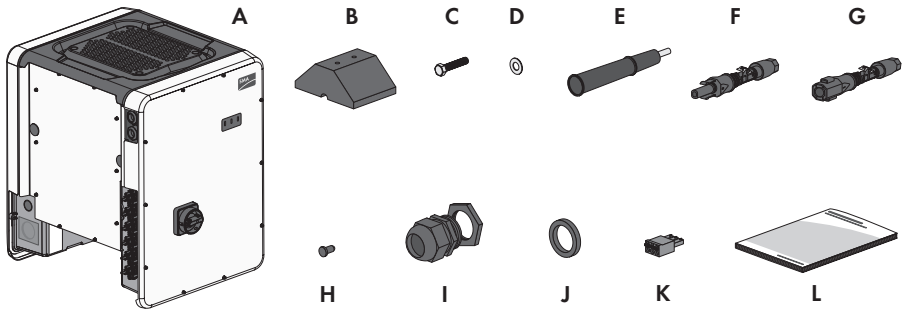

Figure 1: Components included in scope of delivery

Position	Quantity	Designation
A	1	Inverter
B	4	Foot
C	8	Hexagon bolt M8x40
D	8	Washer
E	4	Carrying handle
F	12	Positive DC connector
G	12	Negative DC connector
H	24	Sealing plug for DC connectors
I	1	Cable gland M63 with counter nut
J	1	Alternative seal insert with reduced clamping range (26 mm to 39 mm) for M63 cable glands
K	1	3-pole terminal block
L	1	Quick reference guide with password label on the rear side The label contains the following information: <ul style="list-style-type: none"> • PIC (Product Identification Code) identification key for registering the system in Sunny Portal • RID (Registration Identifier) registration ID for registering the system in Sunny Portal • WLAN password WPA2-PSK (WiFi Protected Access 2 - Preshared Key) for direct connection to the inverter via WLAN

4 Product Overview

4.1 Product Description

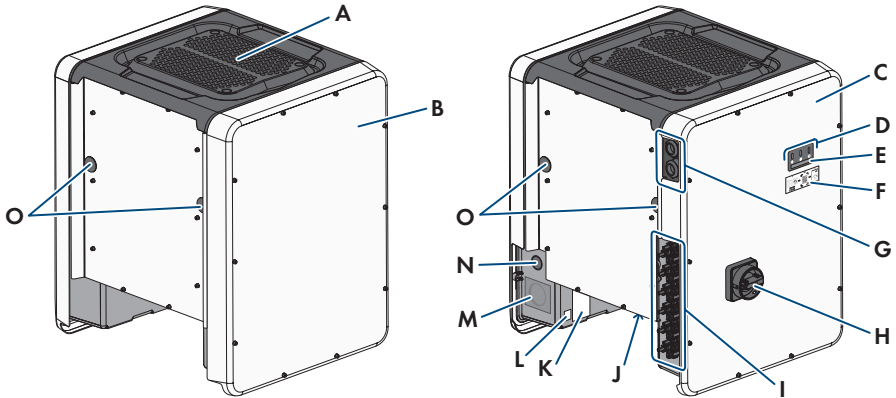

















Figure 2: Design of the product





Position	Designation
A	Cover
B	AC Connection Unit
C	DC Connection Unit
D	LEDs The LEDs indicate the operating state of the product.
E	Display (optional) The product is equipped with a display upon request. The display shows the current operating data and events or errors.
F	Cable glands for data cables
G	DC load-break switch
H	DC connector
I	Fan bracket with three fans

Position	Designation
J	<p>Type label</p> <p>The type label clearly identifies the product. The type label must remain permanently attached to the product. You will find the following information on the type label:</p> <ul style="list-style-type: none"> • Device type (Model) • Serial number (Serial No. or S/N) • Date of manufacture • Device-specific characteristics
K	<p>Additional label with details for registration in Sunny Portal and WLAN password:</p> <ul style="list-style-type: none"> • Identification key (PIC) for registration in Sunny Portal • Registration ID (RID) for registration in Sunny Portal • WLAN password (WPA2-PSK) for the direct connection to the user interface of the inverter via WLAN
L	Enclosure opening for AC connection
M	Enclosure opening for additional cable
N	Enclosure opening for carrying handle

4.2 Symbols on the Product

Icon	Explanation
	<p>Beware of a danger zone</p> <p>This symbol indicates that the product must be additionally grounded if additional grounding or equipotential bonding is required at the installation site.</p>
	<p>Beware of electrical voltage</p> <p>The product operates at high voltages.</p>
	<p>Beware of hot surface</p> <p>The product can get hot during operation.</p>
	<p>Observe the documentations</p> <p>Observe all documentations supplied with the product.</p>
	<p>Inverter</p> <p>Together with the green LED, this symbol indicates the operating state of the inverter.</p>

Icon	Explanation
	Observe the documentations Together with the red LED, this symbol indicates an error.
	Data transmission Together with the blue LED, this symbol indicates the status of the network connection.
	Grounding conductor This symbol indicates the position for connecting a grounding conductor.
	Grounding This symbol indicates the position for the connection of an additional grounding conductor.
	Three-phase alternating current with neutral conductor
	Direct current
	The product has no galvanic isolation.
	WEEE designation Do not dispose of the product together with the household waste but in accordance with the disposal regulations for electronic waste applicable at the installation site.
	The product is suitable for outdoor installation.
IP65	Degree of protection IP65 The product is protected against the penetration of dust and water that is directed as a jet against the enclosure from all directions.
CE	CE marking The product complies with the requirements of the applicable EU directives.
UK CA	UKCA marking The product complies with the regulations of the applicable laws of England, Wales and Scotland.
	RoHS labeling The product complies with the requirements of the applicable EU directives.

Icon	Explanation
	RCM (Regulatory Compliance Mark) The product complies with the requirements of the applicable Australian standards.
 TA-2017/1911 APPROVED	ICASA The product complies with the requirements of the South African standards for telecommunication.
 ANATEL Agência Nacional de Telecomunicações 08492-17-03337	ANATEL The product complies with the requirements of the Brazilian standards for telecommunication. Este equipamento opera em caráter secundário, isto é, não tem direito a proteção contra interferência prejudicial, mesmo de estações do mesmo tipo, e não pode causar interferência a sistemas operando em caráter primário.
	The product complies with the Moroccan safety and EMC requirements for electronic products.

4.3 Interfaces and Functions

The inverter can be equipped or retrofitted with the following interfaces and functions:

User interface for configuration and monitoring

The product is equipped as standard with an integrated webserver, which provides a user interface for configuring and monitoring the product.

Once the connection has been established to the smart device, use a terminal (e.g. smartphone, tablet or laptop) to connect to the product's user interface using a web browser.

Smart Inverter Screen

The Smart Inverter Screen enables you to view the status display and to display the current power and consumption on the user interface login page. This gives you an overview of the most important product data without having to log into the user interface.

The Smart Inverter Screen is deactivated by default. The Smart Inverter Screen can be activated via the user interface once the product has been commissioned.

Display of I-V characteristic curve

Only the STP 50-41 is equipped with this function.

On the user interface of the product, a characteristic curve can be generated from current and voltage values of the PV array per MPP tracker. Using this I-V characteristic curve, problems in the PV array can be detected at an early stage.

SMA Speedwire

The product is equipped with SMA Speedwire as standard. SMA Speedwire is a type of communication based on the Ethernet standard. SMA Speedwire is designed for a data transfer rate of 100 Mbps and enables optimum communication between Speedwire devices within systems.

The products supports the encrypted system communication with SMA Speedwire Encrypted Communication. In order to be able to use the Speedwire encryption in the system, all Speedwire devices, except for the SMA Energy Meter, must support the function SMA Speedwire Encrypted Communication.

SMA Webconnect

The inverter is equipped with a Webconnect function as standard. The Webconnect function enables direct data transmission between the inverter and Sunny Portal without any additional communication device and for a maximum of 4 inverters per visualized system. In PV systems with more than 4 inverters, there is the option of establishing data transmission between the inverters and Sunny Portal via the data logger (e.g., SMA Data Manager) or distributing the inverters over several systems. You can directly access your visualized system via the web browser on your end device.

WLAN connection to SMA 360° app

There is a QR code on the product by default. If the product is equipped with a Wi-Fi interface, you can access the product via Wi-Fi by scanning the QR code on the product using the SMA 360° or SMA Energy app. This automatically connects to the user interface.

Wi-Fi

Depending on availability, the product is or is not equipped with a Wi-Fi interface. If the Wi-Fi interface is present, the Wi-Fi interface is enabled by default at delivery. If you do not want to use WLAN, you can deactivate the WLAN interface.

If the Wi-Fi interface is present, the product also has a WPS function. The WPS function is for automatically connecting the product to a network (e.g. via router) and establish a direct connection between the product and a smart end device.

Expanding the radio range in the WLAN network

In order to expand the radio range of the inverter in the WLAN network, you can install the Antenna Extension Kit accessory set in the inverter.

Modbus

The product is equipped with a Modbus interface. The Modbus interface is deactivated by default and must be configured as needed.

The Modbus interface of the supported SMA products is designed for industrial use – via SCADA systems, for example – and has the following tasks:

- Remote query of measured values
- Remote setting of operating parameters
- Setpoint specifications for system control

Module slots

The inverter is standard-equipped with two module slots. The module slots are located on the communication assembly and allow additional modules to be connected (e.g. SMA Sensor Module). The modules are available as accessories. The installation of two identical modules is not permissible.

SMA RS485 Module

With the assembly of the RS485 Module, the inverter can communicate with special SMA communication products (Information on assembly and connection see manual of the SMA RS485 Module). The SMA RS485 Module can be retrofitted.

Antenna Extension Kit

Within the WLAN network, the Antenna Extension Kit enables the radio range of the inverter to be upgraded (Information on assembly and connection see manual of the Antenna Extension Kit). The Antenna Extension Kit can be retrofitted.

SMA Sensor Module

The SMA Sensor Module has different interfaces for connecting various sensors (i.e. temperature sensor, irradiation sensor, anemometer or energy meter). The SMA Sensor Module converts the signals of the connected sensors and transmits them to the inverter. Information on installation, connection and configuration can be found in the manual for the SMA sensor module. The SMA Sensor Module can be retrofitted.

SMA I/O modules

The SMA I/O module enables the inverter to perform grid management services. Information on installation, connection and configuration can be found in the manual for the SMA I/O module. The SMA I/O Module can be retrofitted.

Grid management services

The product is equipped with service functions for grid management.

Depending on the requirements of the grid operator, you can activate and configure the functions (e.g. active power limitation) via operating parameters.

Grid and PV system protection

The inverter is equipped with redundant and monitored switching elements for grid disconnection simplifying grid and PV system protection required according to VDE-AR-N 4105, In this case the disconnection devices integrated in the inverter can replace an external tie switch. An external, certified monitoring unit with an integrated PV system protection relay (potential-free) and an alarm contact (implemented as break contact) must be included. In addition, the inverter must be equipped with firmware version > 3.01.00.R and an SMA I/O Module. The inverter can be connected to the monitoring unit of the grid and PV system protection device via the SMA I/O Module and receive the signal for grid disconnection (for further information see technical information "SUNNY TRIPOWER CORE1 - Simplified Implementation of Grid and PV System Protection in PV System in accordance with VDE-AR-N 4105:2018-11").

Multifunction Relay

The inverter is equipped with a multifunction relay as standard. The multifunction relay is an interface that can be configured for the operating mode used by a particular system.

SMA ShadeFix

The inverter is equipped with the shade management system SMA ShadeFix. SMA ShadeFix uses an intelligent MPP tracking system to determine the operating point with the highest output during shading conditions. With SMA ShadeFix, inverters use the best possible energy supply from the PV modules at all times to increase yields in shaded systems. SMA ShadeFix is enabled by default. The time interval of SMA ShadeFix is usually six minutes. This means that the inverter determines the optimum operating point every six minutes. Depending on the PV system or shading situation, it may be useful to adjust the time interval.

String-failure detection

The string-failure detection measures the total current of every input and continuously calculates the mean values for the inputs in question. The total currents are compared with the mean values. If a total current exceeds or falls short of the mean value by the set tolerance value, an event is reported. Marginally increased total currents are reliably detected over several query intervals and distinguished from typical current fluctuations of the PV array. String-failure detection is deactivated by default and must be activated. In addition, the tolerance value can be set via the user interface and the mean values read off.

Surge arrester type 1 and 2

On the AC and DC side, the inverter is equipped with slots for type 1 and 2 surge protection devices. The surge protection devices limit dangerous overvoltages. The surge protection devices can be retrofitted.

Arc-Fault Circuit Interrupter (AFCI)

Only the STP 50-41 is equipped with this function.

In accordance with the *National Electrical Code*[®], the inverter has a system for DC arc fault detection and interruption. The arc-fault circuit interrupter is listed in accordance with UL 1699B Ed. 1. A detected electric arc causes the inverter to interrupt feed-in operation. To restart feed-in operation, the operational disruption which has occurred must be reset. Alternatively, the arc-fault circuit interrupter can be activated without inhibiting operation. Depending on the country data set, arc fault detection is activated or deactivated by default. If the installation conditions allow it, you can change the default setting.

SMA Smart Connected

SMA Smart Connected is the free monitoring of the product via the SMA Sunny Portal. Thanks to SMA Smart Connected, the operator and qualified person will be informed automatically and proactively about product events that occur.

SMA Smart Connected is activated during registration in Sunny Portal. In order to use SMA Smart Connected, it is necessary that the product is permanently connected to Sunny Portal and the data of the operator and qualified person is stored in Sunny Portal and up-to-date.

Universal mounting system (UMS_Kit-10)

The universal mounting system enables wall mounting of the inverter or serves as platform for higher mounting on the ground. The universal mounting system is available as an accessory.

4.4 LED Signals

The LEDs indicate the operating state of the product.

LED signal	Explanation
Green LED and red LED flash simultaneously (2 s on and 2 s off)	No country data set set Operation of the product is stopped because no country data set is set. Once the configuration has been completed (for instance using the installation assistant or via a communication product), the product will start operation automatically.
The green LED is flashing (two seconds on and two seconds off)	Waiting for feed-in conditions The conditions for feed-in operation are not yet met. As soon as the conditions are met, the inverter will start feed-in operation.
The green LED flashes quickly	Update of central processing unit The central processing unit of the inverter is being updated.
The green LED is glowing	Feed-in operation The inverter feeds in with a power of at least 90%.
The green LED is pulsing	Feed-in operation The inverter is equipped with a dynamic power display via the green LED. Depending on the power, the green LED pulses fast or slow. If necessary, you can switch off the dynamic power display via the green LED.
The green LED is off	The inverter is not feeding into the utility grid.
The red LED is glowing	Event occurred If an event occurs, a distinct event message and the corresponding event number will be displayed in addition on the product user interface or in the communication product (e.g. SMA Data Manager).
The blue LED flashes slowly for approx. 1 minute	Communication connection is being established The product is establishing a connection to a local network or is establishing a direct connection to a smart device via Ethernet (e.g. smartphone, tablet or laptop).
The blue LED flashes quickly for approx. two minutes (0.25 s on and 0.25 s off).	WPS active The WPS function is active.
The blue LED is glowing	There is an active connection with a local network (LAN/Wi-Fi) or there is a direct connection (Ethernet/WPS function) with a smart end device (e.g. smartphone, tablet or laptop).

4.5 Display messages

Display message	Explanation
Package	Installed firmware version and configured country data set
Ser	Product serial number
HW	Hardware version of the product
FW-HP	Firmware version of the central processing unit
FW-KP	Firmware version of the communication processor
Ethcom A	Status of the network port A
Ethcom B	Status of the network port B
E-IP	Ethernet IP address of the product
SMsk	Subnet mask of the product
GW	Gateway address of the product
DNS	IP address of the domain name server
Wlancom	Status of the WLAN connection
W-IP	WLAN IP address of the product
DC A	Status of the DC input A
DC B	Status of the DC input B
DC C	Status of the DC input C
DC D	Status of the DC input D
DC E	Status of the DC input E
DC F	Status of the DC input F
AC1	Voltage/current between line conductors and neutral conductor
AC2	Voltage/current between line conductors and neutral conductor
AC3	Voltage/current between line conductors and neutral conductor
Update status	Firmware update information
Error	An event has occurred.
P	Instantaneous output power
E-Total	Total produced energy
Pmax	Currently set active power limit
cos φ	Displacement power factor cos φ
Update file(s) found	New firmware version available
Update progress	Update is being performed

4.6 System Overview

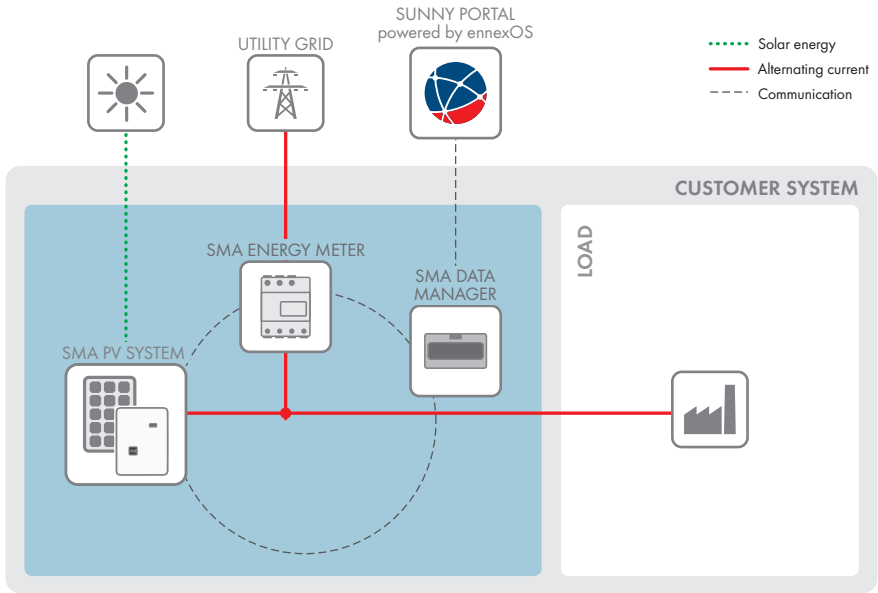

Figure 3: Design of the system

4.6.1 Circuitry Overview

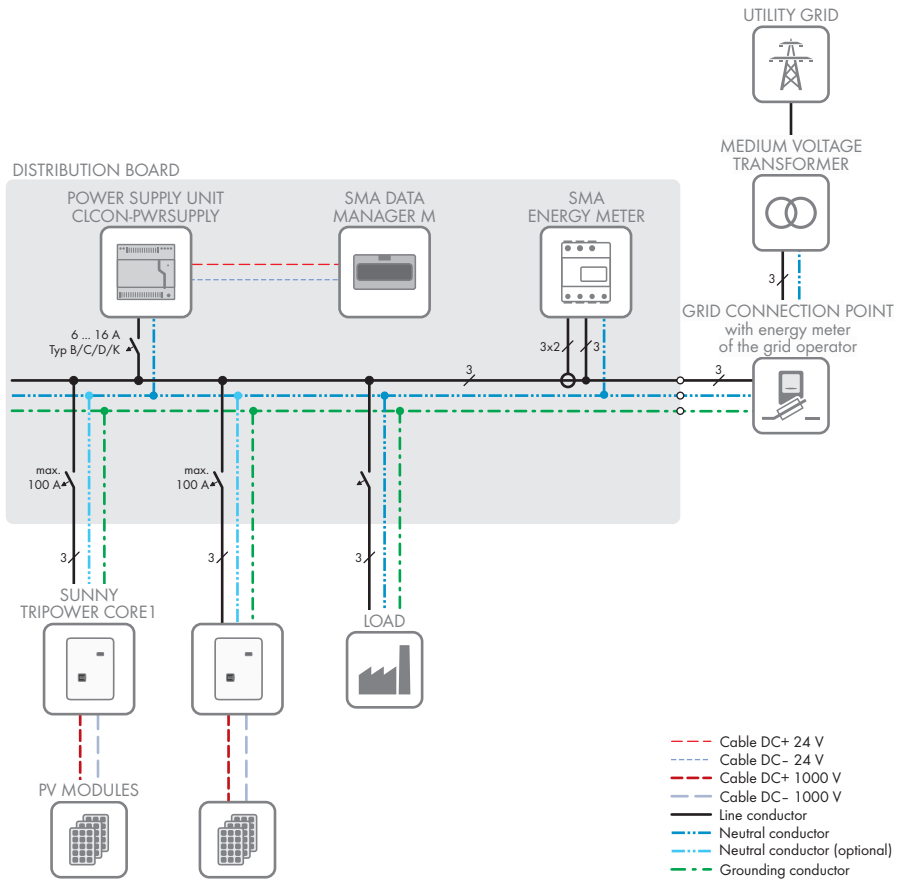

Figure 4: Circuitry overview (example)

4.6.2 Communication Overview

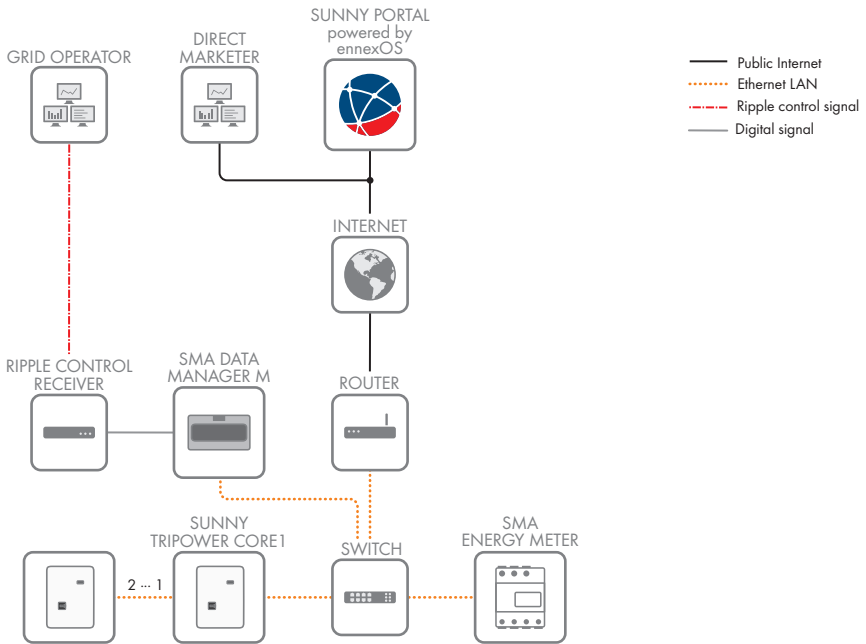

Figure 5: Design of system communication

5 Mounting

5.1 Requirements for Mounting

Requirements for the mounting location:

⚠ WARNING

Danger to life due to fire or explosion

Despite careful construction, electrical devices can cause fires. This can result in death or serious injury.

- Do not mount the product in areas containing highly flammable materials or gases.
 - Do not mount the product in potentially explosive atmospheres.
- The mounting location must be inaccessible to children.
 - The mounting location must be suitable for the weight and dimensions of the product (see Section 13, page 115).
 - The installation site can be exposed to direct solar irradiation. There is, however, the possibility that the product reduces its power output to avoid overheating due to high temperatures.
 - The mounting location should be freely and safely accessible at all times without the need for any auxiliary equipment (such as scaffolding or lifting platforms). Non-fulfilment of these criteria may restrict servicing.
 - The DC load-break switch of the product must always be freely accessible.
 - All ambient conditions must be met (see Section 13, page 115).

Permitted and prohibited mounting positions:

- The product may only be mounted in a permitted position. This will ensure that no moisture can penetrate the product.
- The product should be mounted such that the LED signals can be read off without difficulty.

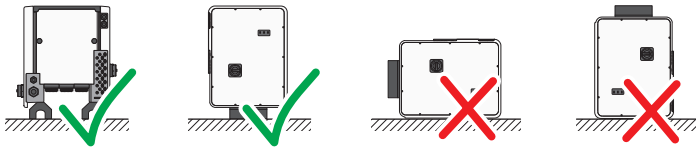

Figure 6: Permitted and prohibited mounting positions

Dimensions for mounting:

NOTICE

Damage to the enclosure by using excessively long screws for attaching profile rails

The maximum thread depth of the drill holes for fastening feet and profile rails is 17 mm. If screws are used with a length that exceeds the thread depth, the drill holes fracture and the enclosure will be damaged.

- When selecting the screws for fastening the profile rails, observe the thread depth of 14 mm to 17 mm and ensure that the thread depth is not exceeded.

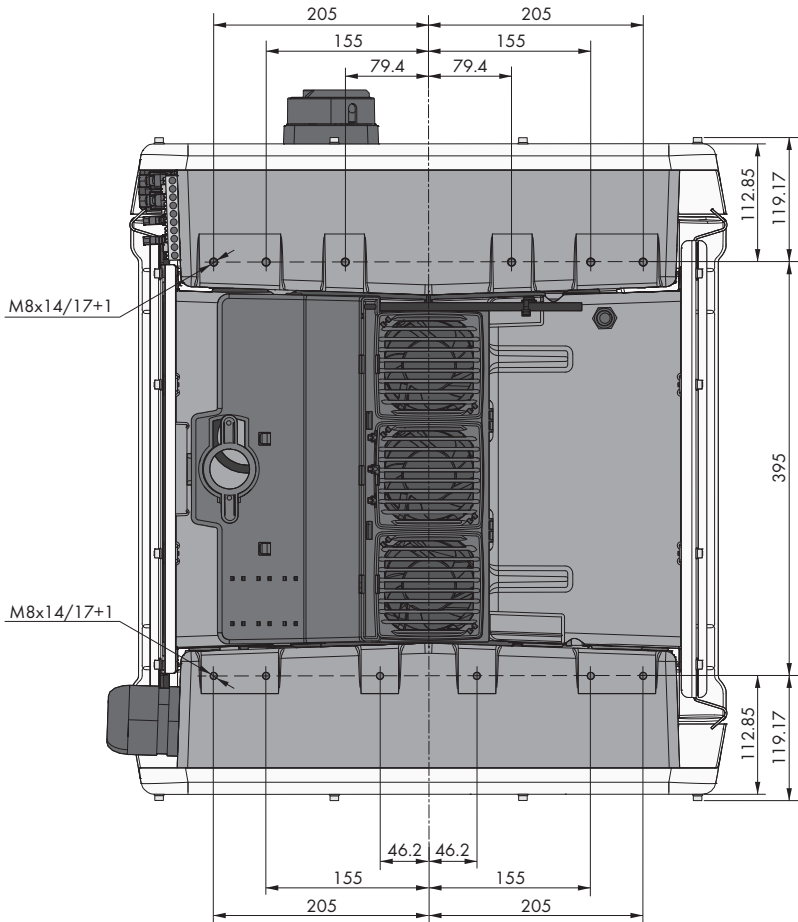

Figure 7: Position of the anchoring points(Dimensions in mm)

Structural Stability:

- When mounting with feet or profile rails, the width of one foot or the profile rail must be at least 175 mm to ensure structural stability.
- The inverter must be attached under the following conditions:
 - Inclination of the support surface: $> 3^\circ$
 - Wind speed (without wind gusts): > 25 m/s
 - Height of the feet or the profile rail: > 100 mm
- When mounting with profile rails, an attachment or fixation by loading is required. When mounting with profile rails, SMA Solar Technology AG recommends to bolt the profile rails e.g. to the profile of the module frame or to attach a sheet metal (which can be weighted with stones or with sandbags) at the profile rails. This will ensure that the inverter is fixed.

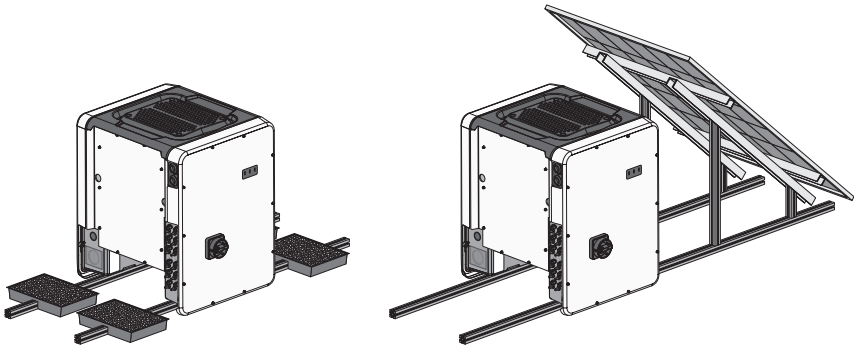

Figure 8: Attachment of the inverters (examples)

Recommended clearances:

If you maintain the recommended clearances, adequate heat dissipation will be ensured. Thus, you will prevent power reduction due to excessive temperature.

- Maintain the recommended clearances to roof edges, skylights, walls as well as to other inverters or objects. This ensures that the DC load-break switch on the inverter can be operated easily and the LED signals can be read without difficulty.
- For possible service deployments, SMA Solar Technology AG recommends ensuring sufficient clearance from walls, other inverters or objects on all four sides of the inverter enclosure. Non-fulfillment of these criteria may restrict servicing.
- If multiple products are mounted in areas with high ambient temperatures, increase the clearances between the products and ensure sufficient fresh-air supply.

i Recommended clearances when using the universal assembly system (UMS_KIT-10)

When using the universal assembly system (UMS_KIT-10), it is possible to deviate from the recommended clearances.

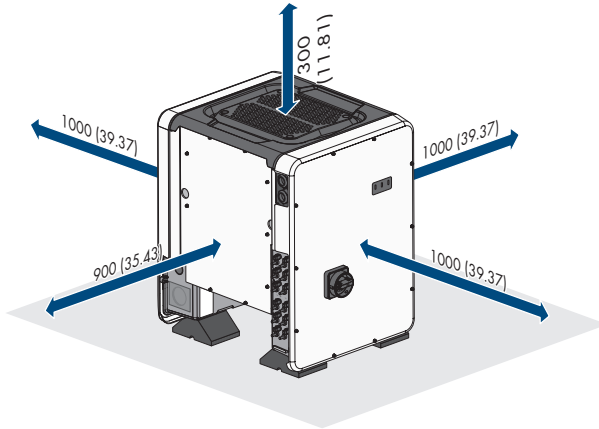

Figure 9: Recommended clearances(Dimensions in mm)

5.2 Mounting the product

⚠ CAUTION

Risk of injury due to weight of product

Injuries may result if the product is lifted incorrectly or dropped while being transported or mounted.

- Carry and lift the product upright with the help of several people. Take the weight and the center of gravity of the product into account. The center of gravity is on the side of the AC-Connection Unit.
- Wear suitable personal protective equipment for all work on the product.
- Transport the product using the carrying handles or hoist. Take the weight of the product into account.
- Use all carrying handles provided during transport with carrying handles.
- Do not use the carrying handles as attachment points for hoist equipment (e.g. straps, ropes, chains). Insert eye bolts into threads provided on top of the product to attach the hoist system.

NOTICE

Damage to the threaded holes due to the use of screws that are too long and exceeding the torque when mounting the feet

If the screws supplied are not used for mounting the feet and the maximum torque is exceeded, the screws will protrude too deeply into the threaded holes. This can cause the threaded hole to fracture and cracks will appear in the enclosure.

- Only use the M8x40 hexagonal head screws supplied for mounting the feet.
- Tighten the screws with a torque of 16 Nm.

Additionally required material (not included in the scope of delivery):

- For transport with a hoist: 4 eye bolts (M8)

Procedure:

1. Attach each foot with two M8x40 hexagon head screws and two washers on the two external taps (M8x14) on the underside of the inverter (torque: 16 Nm). Press the packaging on the bottom side down or cut it open. The screw holes on the bottom of the inverter must be exposed.

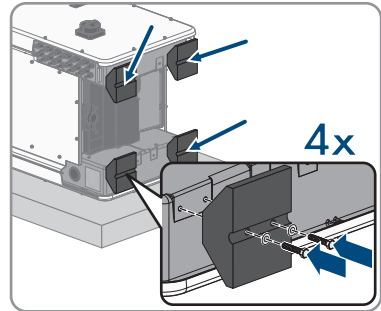

2. Screw the transport handles as far as they will go into the taps on the right- and left-hand side until they lie flush with the enclosure. When doing so, ensure that the transport handles are screwed into the taps so that they are perfectly straight. If the transport handles are not screwed in straight, this can make it more difficult or even impossible to unscrew them later on and can damage the taps to the extent that transport handles can no longer be screwed into them.

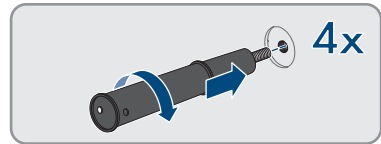

3. Insert a screwdriver into the holes in the transport handle and turn the screwdriver through 90°. This ensures that the transport handles are securely tightened.

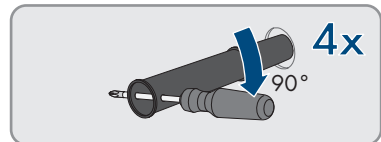

4. Remove the inverter from the Euro pallet and position the inverter at the installation location.

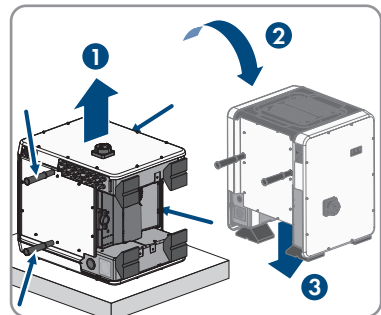

5. If the inverter is positioned by means of a hoist at the mounting location, screw the eye bolts into the threads on the top of the inverter and attach the hoist to them. The hoist must be suitable to take the weight of the inverter.
6. Make sure that the inverter is stable.

- Remove all 4 transport handles from the threaded holes. If necessary, insert a screwdriver into the holes on the transport handle and use the screwdriver to remove the transport handle.

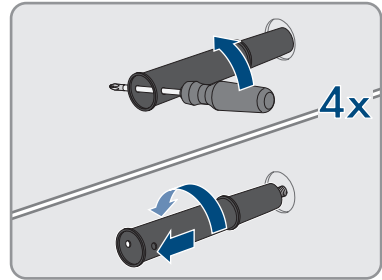

6 Electrical Connection

6.1 Overview of the Connection Area

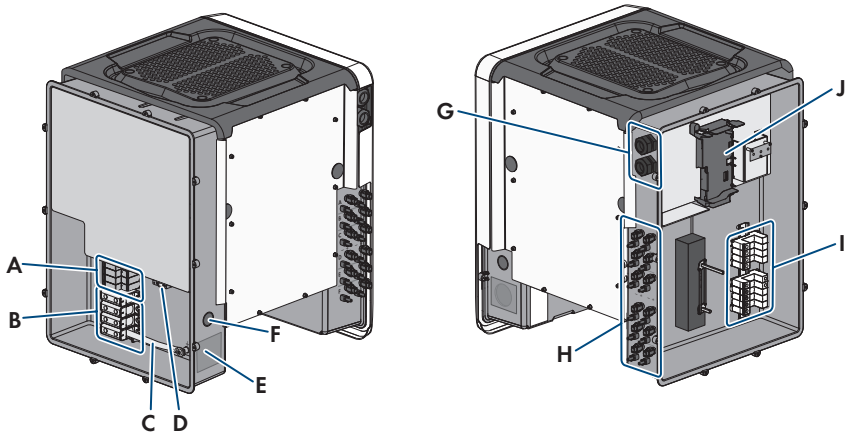

Figure 10: Connection areas of the inverters' AC Connection Unit and DC Connection Unit

Position	Designation
A	Slots for AC surge protection devices
B	Terminal blocks for AC connection
C	Bridge between N and enclosure
D	Grounding terminal for grounding conductor connection
E	Enclosure opening for cable gland M63
F	Enclosure opening for additional cable
G	Cable glands for network cables and, if needed, for the connection cables of the Antenna Extension Kit or other data cables
H	Positive and negative connectors for DC connection
I	Slots for DC surge protection devices
J	Communication assembly

6.2 AC Connection

6.2.1 Requirements for the AC Connection

AC cable requirements as follows:

- Conductor type: aluminum and copper wire
- External diameter: 35 mm to 48 mm / 26 mm to 39 mm

- Conductor cross-section of grounding conductor: 25 mm² to 120 mm²
- Conductor cross-section of line conductor and neutral conductor: 35 mm² to 120 mm²
- Insulation stripping length: 30 mm
- Sheath stripping length: 290 mm
- The cable must be dimensioned in accordance with the local and national directives for the dimensioning of cables. The requirements for the minimum wire size derive from these directives. Examples of factors influencing cable dimensioning are: nominal AC current, type of cable, routing method, cable bundling, ambient temperature and maximum desired line losses (for calculation of line losses, see the design software "Sunny Design" from software version 2.0 at www.SMA-Solar.com).

Overview of the required length of the conductor inside the AC connection unit

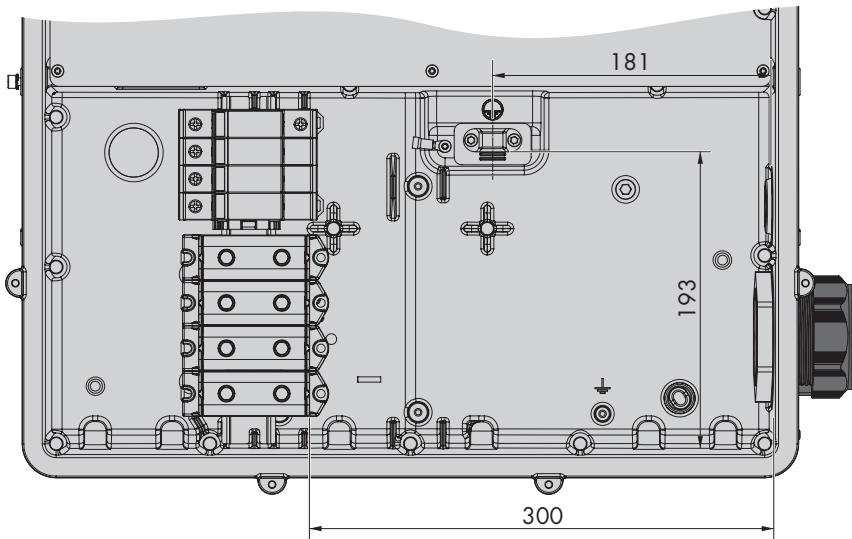

Figure 11: Interior view of the AC connection unit with dimensions for the conductors (Dimensions in mm)

Load-break switch and cable protection:

NOTICE

Damage to the inverter due to the use of screw-type fuses as load-break switches

Screw-type fuses (e.g. DIAZED fuse or NEOZED fuse) are not load-break switches.

- Do not use screw-type fuses as load-break switches.
- Use a load-break switch or circuit breaker as a load disconnection unit (for information and design examples, see the Technical Information "Circuit Breaker" at www.SMA-Solar.com).

- In PV systems with multiple inverters, protect each inverter with a separate three-phase circuit breaker. Make sure to observe the maximum permissible fuse protection (see Section 13 "Technical Data", page 115). This will prevent residual voltage from being present at the corresponding cable after disconnection.
- Loads installed between the inverter and the circuit breaker must be fused separately.

Residual-current monitoring unit:

The inverter does not require an external residual-current device when operating. If local regulations require the use of a residual-current device, the following must be observed:

- The inverter is compatible with type B residual-current devices that have a rated residual current of 300 mA or higher (information about the selection of a residual-current device see technical information "Criteria for Selecting a Residual-Current Device" at www.SMA-Solar.com). Each inverter in the system must be connected to the utility grid via a separate residual-current device.
- When using residual-current devices with a rated residual current < 500 mA, the rated residual current must be set in the inverter (see Section 8.21, page 81). In this way the inverter reduces the operational leakage currents and prevents a false triggering of the residual-current device.

Overvoltage category:

The product can be used in grids of overvoltage category III or lower in accordance with IEC 60664-1. That means that the product can be permanently connected to the grid-connection point of a building. In case of installations with long outdoor cabling routes, additional measures to reduce overvoltage category IV to overvoltage category III are required (see the Technical Information "Overvoltage Protection" at www.SMA-Solar.com).

6.2.2 Connecting the Inverter to the Utility Grid

QUALIFIED PERSON

Requirements:

- The connection requirements of the grid operator must be met.
- The grid voltage must be within the permissible range. The exact operating range of the inverter is specified in the operating parameters.

Procedure:

1. Disconnect the miniature circuit breaker from all 3 line conductors and secure against reconnection.
2. Ensure that the DC load-break switch is in the **O** position and is secured against reconnection.

3. If the enclosure lid of the AC Connection Unit is mounted, remove all 10 screws of the enclosure lid using a Torx screwdriver (TX25) and remove the enclosure lid towards the front.

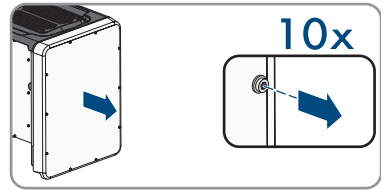

4. Remove the adhesive tape from the enclosure opening for the AC connection.
5. Insert the cable gland M63 into the opening and tighten it with the counter nut from the inside.

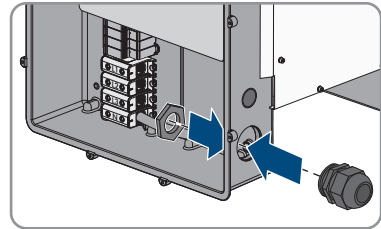

6. Thread the AC cable through the cable gland into the AC Connection Unit. If necessary, slightly loosen the swivel nut of the cable gland. In case of AC cables that require a clamping area $< 35 \text{ mm}$, replace the seal insert of the cable gland M63 by the seal insert with reduced clamping range.

7. Dismantle the AC cable.

8. Strip off the insulation of L1, L2, L3, N and PE by 30 mm.

9. Connect the grounding conductor to the ground terminal. Use a Torx screwdriver (TX 25) to slightly loosen one of the screws with which the clip and connection plate are connected to the ground connection and to completely remove the other screw. Then place the grounding conductor onto the connection plate, route the clip via the grounding conductor and tighten both screws with a Torx screwdriver (TX 25) (torque: 6 Nm).

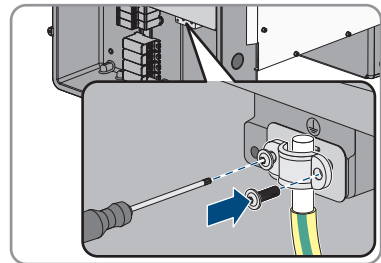

10. Ensure that the conductor is on the connection plate.

11. Connect L1, L2, L3 and, if necessary, N to the terminals according to the label. To do so, position each conductor as far as they will go into the corresponding terminal and tighten the screw of the terminal using an Allen key (AF 8, length: 50 mm) (20 Nm torque for a conductor cross-section of 35 mm^2 to 95 mm^2 ; 30 Nm torque for a cable cross-section of 120 mm^2).

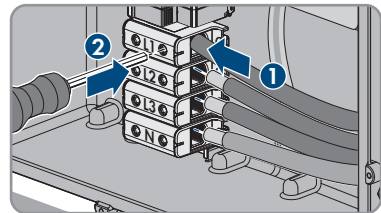

12.

⚠ WARNING**Danger to life due to electric shock**

The inverter is delivered with a bridge between N and the enclosure as standard. The bridge is absolutely essential if the connection to a utility grid is established without a neutral conductor.

- If the connection to a utility grid is established with a neutral conductor, the bridge must always be removed as described in the next step.

13. When N is present and connected to the corresponding terminal, remove the bridge installed as standard between N and the enclosure (⚡). To do so, unscrew the screw of the terminal **N** and the screw of the grounding point (⚡) using an Allen key (AF 8, length: 50 mm) and remove the bridge from the inverter.

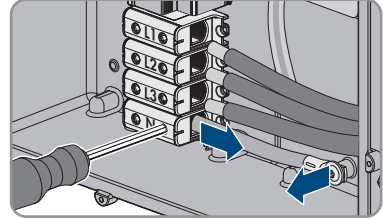

14. Ensure that the correct conductors are assigned to all the terminals.
15. Make sure that all conductors are securely in place.

6.3 Connecting the Network Cables

⚠ QUALIFIED PERSON**⚠ DANGER****Danger to life due to electric shock in case of overvoltages and if surge protection is missing**

Overvoltages (e. g. in the event of a flash of lightning) can be further conducted into the building and to other connected devices in the same network via the network cables or other data cables if there is no surge protection. Touching live parts and cables results in death or lethal injuries due to electric shock.

- Ensure that all devices in the same network are integrated in the existing overvoltage protection.
- When laying the network cable outdoors, ensure that there is suitable surge protection at the network cable transition from the product outdoors to the network inside the building.
- The Ethernet interface of the product is classified as "TNV-1" and offers protection against overvoltages of up to 1.5 kV.

Additionally required material (not included in the scope of delivery):

- Network cables
- Where required: Field-assembly RJ45 connector.

Network cable requirements:

The cable length and quality affect the quality of the signal. Observe the following cable requirements:

- Cable type: 100BaseTx
- Cable category: minimum CAT5e
- Plug type: RJ45 of Cat5, Cat5e or higher
- Shielding: SF/UTP, S/UTP, SF/FTP or S/FTP
- Number of insulated conductor pairs and insulated conductor cross-section: at least 2 x 2 x 0.22 mm²
- Maximum cable length between 2 nodes when using patch cables: 50 m
- Maximum cable length between 2 nodes when using installation cables: 100 m
- UV-resistant for outdoor use.

Procedure:

1.

⚠ DANGER**Danger to life due to electric shock**

- Disconnect the inverter from all voltage sources (see Section 9, page 88).

2. If the enclosure lid of the DC-Connection Unit is closed, remove it as follows: Unscrew all ten screws with a Torx screwdriver (TX25) and remove the enclosure lid carefully forward.

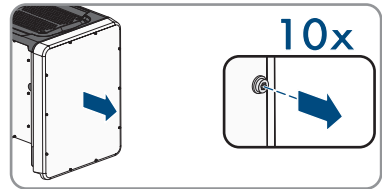

3. Set the screws and the enclosure lid aside and store safely.
4. Remove the swivel nut from the cable gland for the communication cable.
5. Thread the swivel nut over the network cable.
6. Remove the two-hole cable support sleeve from the cable gland.
7. Remove the sealing plug from one of the enclosure openings of the two-hole cable support sleeve and insert the network cable into the enclosure opening.
8. Press the two-hole cable support sleeve with the cable into the cable gland and guide the network cable to the communication assembly in the DC Connection Unit. Ensure that any unused enclosure openings of the two-hole cable support sleeve are sealed with sealing plugs.
9. When using a self-assembly network cable, assemble the RJ45 connectors and connect them to the network cable (see connector documentation).
10. Put the RJ45 plug of the cable into one of the network sockets of the communication assembly.

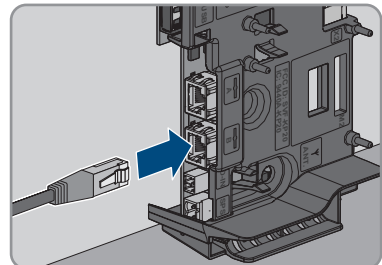

11. Ensure that the RJ45 plug is securely in place by pulling slightly on the cable.
12. Tighten the swivel nut on the cable gland hand-tight. This will secure the network cable in place.
13. If the inverter is installed outdoors, install overvoltage protection for all components in the network.
14. If you would like to integrate the inverter into a local network, connect the other end of the network cable to the local network (e.g. via a router).

6.4 Connecting the Multifunction Relay

6.4.1 Procedure for connecting the multifunction relay

QUALIFIED PERSON

Procedure	See
1. Select for which operating mode you would like to use the multifunction relay.	Section 6.4.2, page 41
2. Connect to the multifunction relay according to the operating mode and the associated connection variant.	Section 6.4.3, page 42 and Section 6.4.4, page 45
3. After commissioning the inverter, change the operating mode of the multifunction relay, if necessary.	Section 8.16, page 77

6.4.2 Operating Modes of the Multifunction Relay

Operating mode of multifunction relay (Mlt.Op-Mode)	Description
Fault indication (FltInd)	The multifunction relay controls a display device (e.g. a warning light) which, depending on the type of connection, signals either an error or the undisturbed operation of the inverter.
Self-consumption (SelfC-mp)	The multifunction relay switches loads on or off, depending on the power production of the PV system.
Control via communication (ComCtl)	The multifunction relay switches loads on or off according to commands transmitted by a communication product.
Battery bank (BatCha)	The multifunction relay controls the charging of the batteries depending on the power production of the PV system.
Fan control (FanCtl)	The multifunction relay controls an external fan, depending on the temperature of the inverter.
Switching status grid relay (GriSwCpy)	The local grid operator may require that a signal is transmitted as soon as the inverter connects to the utility grid. The multifunction relay can be used to trigger this signal.

6.4.3 Connection Options

The connection procedures vary, depending on the operating mode.

Operating mode	Connection option
Fault indication (FltInd)	Using the Multifunction Relay as a Fault Indicator Contact
Self-consumption (SelfC-smp)	Controlling loads via the multifunction relay or charging batteries depending on the power production of the PV system
Control via communication (ComCtl)	Controlling loads via the multifunction relay or charging batteries depending on the power production of the PV system
Battery bank (BatCha)	Controlling loads via the multifunction relay or charging batteries depending on the power production of the PV system
Fan control (FanCtl)	Connecting the external fan (see fan documentation)
Switching status grid relay (GriSwCpy)	Reporting the switching status of the grid relay

Using the Multifunction Relay as a Fault Indicator Contact

You can use the multifunction relay as a fault indicator contact and have an error or smooth operation of the inverter displayed or signaled via a suitable display device. You can connect multiple inverters to one fault indicator or operation indicator, as needed.

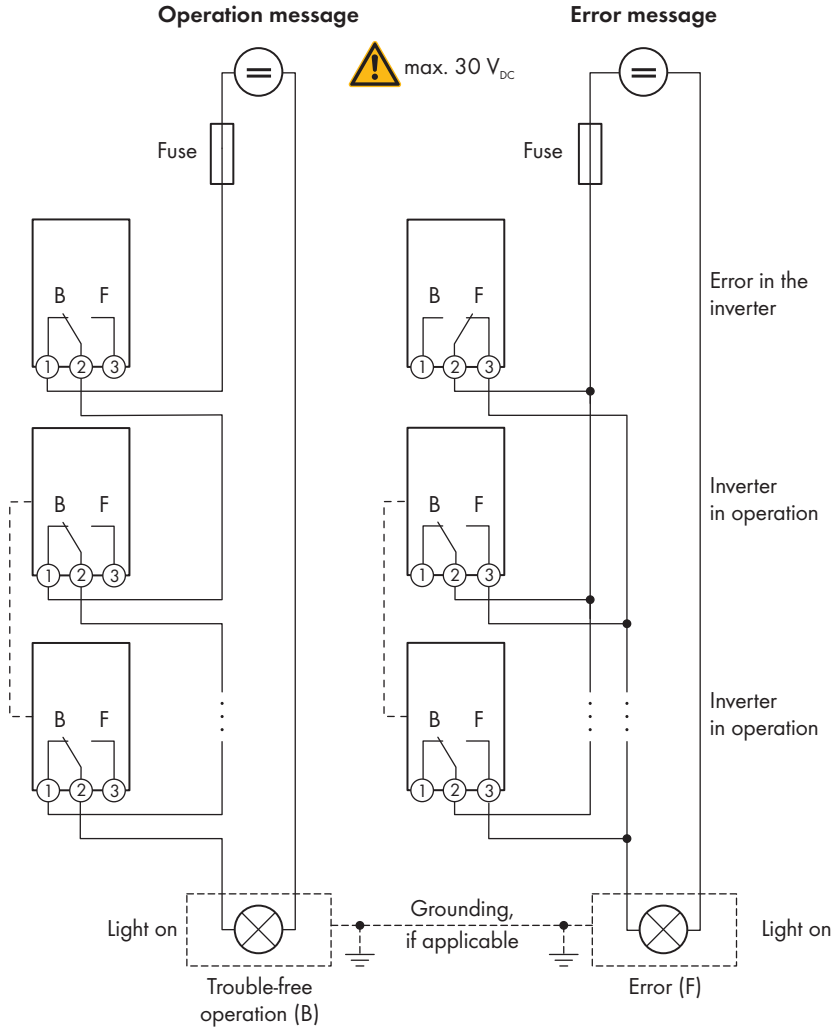

Figure 12: Circuit diagram with multiple inverters for connection to an operation indicator and circuit diagram for connection to a fault indicator (example)

Controlling loads via the multifunction relay or charging batteries depending on the power production of the PV system

The multifunction relay can control loads or charge batteries power-dependently. To enable this function, you must connect a contactor (K1) to the multifunction relay. The contactor (K1) switches the operating current for the load on or off. If you want batteries to be charged depending on the available power, the contactor activates or deactivates the charging of the batteries.

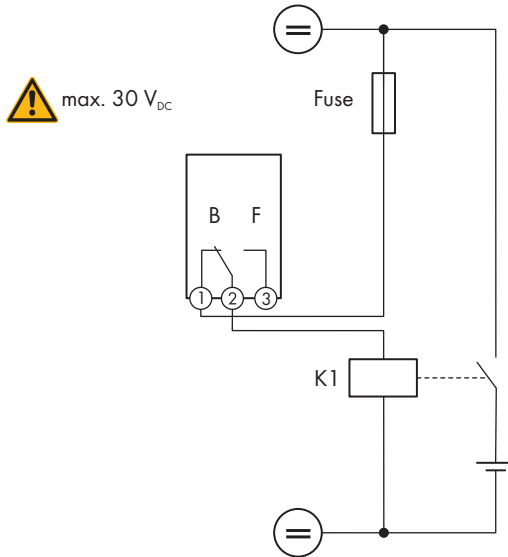

Figure 13: Wiring diagram for connection for controlling a load or for the power-dependent charging of the batteries

Reporting the switching status of the grid relay

The multifunction relay can trip a signal to the grid operator as soon as the inverter connects to the utility grid. To enable this function, the multifunction relays of all inverters must be connected in parallel.

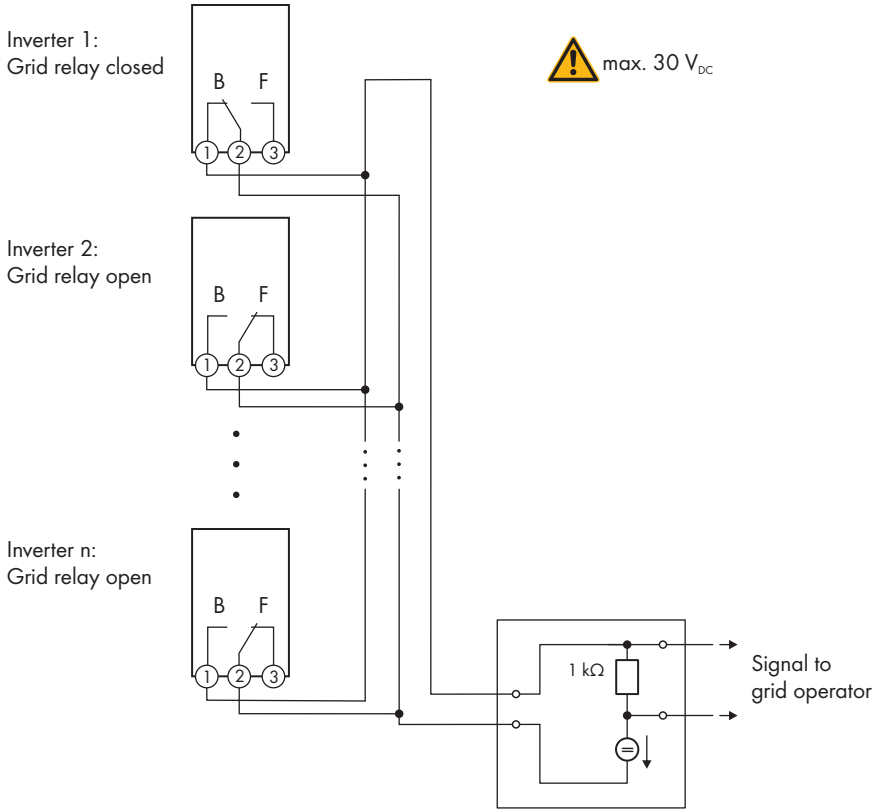

Figure 14: Wiring diagram for signaling the switching status of the grid relay (example)

6.4.4 Connection to the Multifunction Relay

⚠ QUALIFIED PERSON

Requirement:

- The technical requirements of the multifunction relay must be met (see Section 13 "Technical Data", page 115).

Cable requirements:

- Conductor cross-section: 0.2 mm² to 1.5 mm²
- The cable type and cable-laying method must be appropriate for the application and location.

Procedure:

1.

⚠ DANGER**Danger to life due to high voltages**

- Disconnect the inverter from all voltage sources (see Section 9, page 88).

2. If the enclosure lid of the DC-Connection Unit is closed, remove it as follows: Unscrew all ten screws with a Torx screwdriver (TX25) and remove the enclosure lid carefully forward.

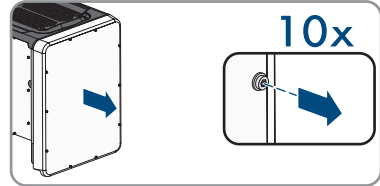

3. Set the screws and the enclosure lid aside and store safely.
 4. Remove the swivel nut from the cable gland for the communication cable.
 5. Remove the two-hole cable support sleeve from the cable gland and insert the cable into the enclosure opening of the two-hole cable support sleeve.
 6. Press the two-hole cable support sleeve with the cable into the cable gland and guide the cable to the communication assembly in the DC Connection Unit. Ensure that any unused enclosure openings of the two-hole cable support sleeve are sealed with sealing plugs.
 7. Strip 9 mm of the cable insulation at maximum.

8. Connect the cable to the 3-pole terminal block according to the circuit diagram, depending on the operating mode (see Section 6.4.3, page 42). Ensure that the conductors are plugged completely into the terminal points up to their insulation.

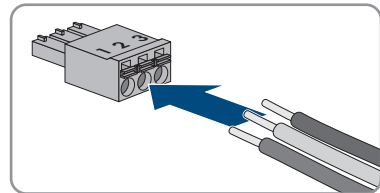

9. Stick the 3-pole terminal block with the connected conductors into the **MFR** slot on the communication assembly in the inverter.

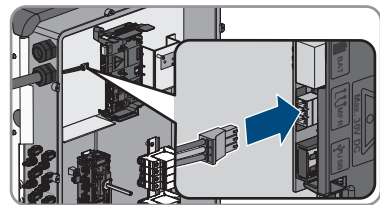

10. Ensure that the terminal block is securely in place.
 11. Ensure that all conductors are correctly connected.
 12. Ensure that the conductors sit securely in the terminal points. Tip: To release the conductors, open the terminal points using a suitable tool.
 13. Tighten the swivel nut on the cable gland hand-tight.

6.5 DC Connection

6.5.1 Requirements for the DC Connection

Requirements for the PV modules per input:

- All PV modules should be of the same type.
- All PV modules should be aligned and tilted identically.
- On the coldest day based on statistical records, the open-circuit voltage of the PV array must never exceed the maximum input voltage of the inverter.
- The same number of series-connected PV modules must be connected to each string.
- The maximum input current per string must be maintained and must not exceed the through-fault current of the DC connectors (see Section 13 "Technical Data", page 115).
- If only one input per MPPT tracker is assigned and AFCI is used at the same time, the maximum input current of the input must not exceed 16 A.
- The thresholds for the input voltage and the input current of the inverter must be adhered to (see Section 13 "Technical Data", page 115).
- The positive connection cables of the PV modules must be equipped with positive DC connectors (see Section 6.5.2, page 47).
- The negative connection cables of the PV modules must be equipped with the negative DC connectors (see Section 6.5.2, page 47).

i Use of Y adapters for parallel connection of strings

The Y adapters must not be used to interrupt the DC circuit.

- Do not use the Y adapters in the immediate vicinity of the inverter. The adapters must not be visible or freely accessible.
- In order to interrupt the DC circuit, always disconnect the inverter as described in this document (see Section 9, page 88).

6.5.2 Assembling the DC Connectors

⚠ QUALIFIED PERSON

⚠ DANGER

Danger to life due to electric shock when live components or DC cables are touched

When exposed to light, the PV modules generate high DC voltage which is present in the DC cables. Touching live DC cables results in death or lethal injuries due to electric shock.

- Do not touch non-insulated parts or cables.
- Disconnect the product from voltage sources and ensure it cannot be reconnected before working on the device.
- Do not disconnect the DC connectors under load.
- Wear suitable personal protective equipment for all work on the product.

NOTICE

Destruction of the inverter due to overvoltage

If the open-circuit voltage of the PV modules exceeds the maximum input voltage of the inverter, the inverter can be destroyed due to overvoltage.

- If the open-circuit voltage of the PV modules exceeds the maximum input voltage of the inverter, do not connect any strings to the inverter and check the design of the PV system.

For connection to the inverter, all PV module connection cables must be fitted with the DC connectors provided. Assemble the DC connectors as described in the following. The procedure is identical for both connectors (+ and -). The graphics for the procedure are shown for only the positive connector as an example. Pay attention to the correct polarity when assembling the DC connectors. The DC connectors are marked with the symbols "+" and "-".

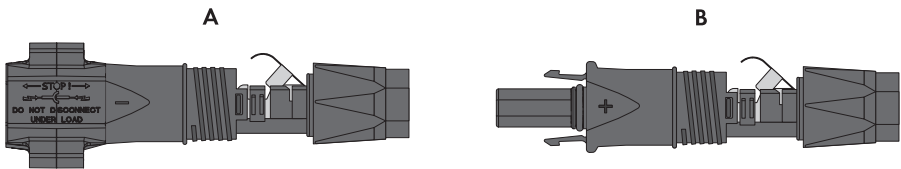

Figure 15: Negative (A) and positive (B) DC connectors

Cable requirements:

- External diameter: 5.5 mm to 8 mm
- Conductor cross-section: 2.5 mm² to 6 mm²
- Qty single wires: minimum 7
- Nominal voltage: minimum 1000 V
- Using bootlace ferrules is not allowed.

Procedure:

1. Strip approx. 15 mm of the cable insulation.
2. Insert the stripped cable into the DC connector up to the stop. When doing so, ensure that the stripped cable and the DC connector are of the same polarity.
3. Press the clamping bracket down until it audibly snaps into place.

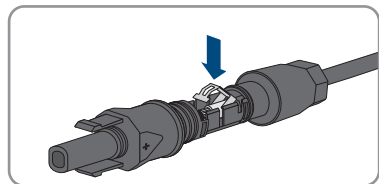
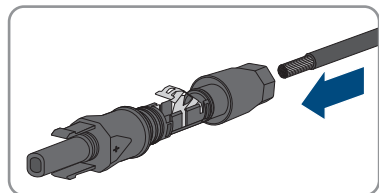

- ☑ The stranded wire can be seen inside the clamping bracket chamber.

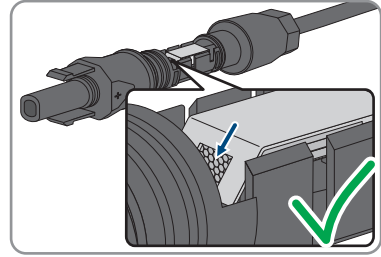

4. If the stranded wire is not visible in the chamber, the cable is not correctly inserted and the connector must be reassembled. To do this, the cable must be removed from the connector.

- Release the clamping bracket. To do so, insert a screwdriver (blade width: 3.5 mm) into the clamping bracket and pry the clamping bracket open.

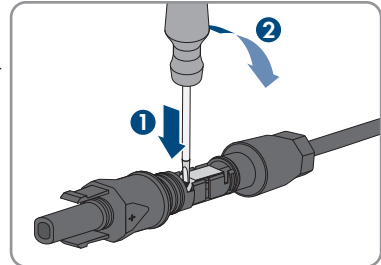

- Remove the cable and go back to step 2.

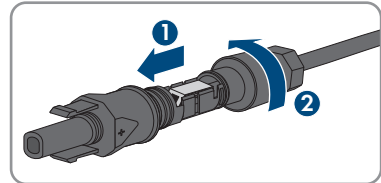

5. Push the swivel nut up to the thread and tighten (torque: 2 Nm).

6.5.3 Connecting the PV Array

⚠ QUALIFIED PERSON

⚠ WARNING

Danger to life due to electric shock from destruction of the measuring device due to overvoltage

Overvoltage can damage a measuring device and result in voltage being present in the enclosure of the measuring device. Touching the live enclosure of the measuring device results in death or lethal injuries due to electric shock.

- Only use measuring devices with a DC input voltage range of 1000 V or higher.

NOTICE**Damage to the product due to ground fault on DC side during operation**

Due to the transformerless topology of the product, the occurrence of ground faults on DC side during operation can lead to irreparable damage. Damages to the product due to a faulty or damaged DC installation are not covered by warranty. The product is equipped with a protective device that checks whether a ground fault is present during the starting sequence. The product is not protected during operation.

- Ensure that the DC installation is carried out correctly and no ground fault occurs during operation.

NOTICE**Damage to the DC connectors due to the use of contact cleaner of other cleaning agents**

Some contact cleaners or other cleaning agents may contain substances that decompose the plastic of the DC connectors.

- Do not use contact cleaners or other cleaning agents for cleaning the DC connectors.

NOTICE**Destruction of the inverter due to overvoltage**

If the open-circuit voltage of the PV modules exceeds the maximum input voltage of the inverter, the inverter can be destroyed due to overvoltage.

- If the open-circuit voltage of the PV modules exceeds the maximum input voltage of the inverter, do not connect any strings to the inverter and check the design of the PV system.

Procedure:

1. Ensure that the miniature circuit breaker is switched off and that it cannot be reconnected.
2. Turn the DC load-break switch of the inverter to position **O**.

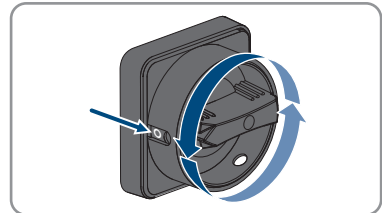

- Secure the DC load-break switch against reconnection using a padlock.

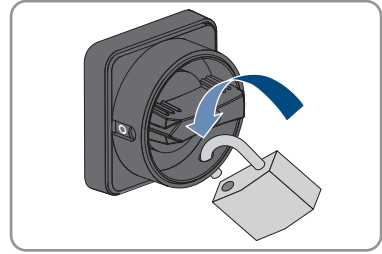

- Measuring the voltage of the PV array. Ensure that the maximum input voltage of the inverter is adhered to and that there is no ground fault in the PV system.
- Check whether the DC connectors have the correct polarity.
If the DC connector is equipped with a DC cable of the wrong polarity, the DC connector must be reassembled. The DC cable must always have the same polarity as the DC connector.
- Ensure that the open-circuit voltage of the PV array does not exceed the maximum input voltage.
- Connect the assembled DC connectors to the inverter.

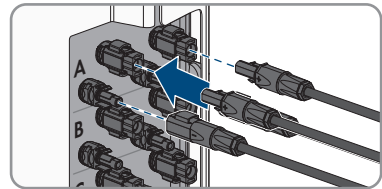

- The DC connectors snap into place.

- Ensure that all DC connectors are securely in place.

9.

NOTICE

Damage to the product due to sand, dust and moisture ingress if the DC inputs are not closed

The product is only properly sealed when all unused DC inputs are closed with DC connectors and sealing plugs. Sand, dust and moisture penetration can damage the product and impair its functionality.

- Seal all unused DC inputs using the DC connectors and sealing plugs as described in the following. When doing so, do not plug the sealing plugs directly into the DC inputs on the inverter.

- For unused DC connectors, push down the clamping bracket and push the swivel nut up to the thread.
- Insert the sealing plug into the DC plug connector.

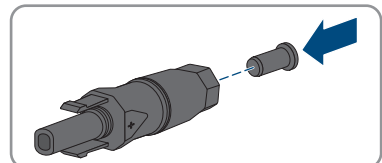

12. Insert the DC connectors with sealing plugs into the corresponding DC inputs on the inverter.

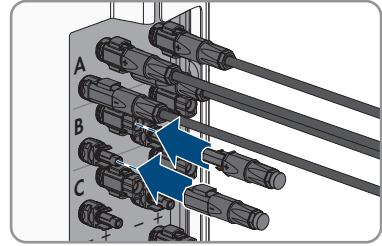

- ☑ The DC connectors snap into place.

13. Ensure that the DC connectors with sealing plugs are securely in place.

6.5.4 Disassembling the DC Connectors

⚠ QUALIFIED PERSON

To disassemble the DC connectors for connection to the pv modules (e.g. due to faulty assembly), proceed as follows.

⚠ DANGER

Danger to life due to electric shock when touching exposed DC conductors or DC plug contacts if the DC connectors are damaged or loose

The DC connectors can break or become damaged, become free of the DC cables, or no longer be connected correctly if the DC connectors are released and disconnected incorrectly. This can result in the DC conductors or DC plug contacts being exposed. Touching live DC conductors or DC plug connectors will result in death or serious injury due to electric shock.

- Wear insulated gloves and use insulated tools when working on the DC connectors.
- Ensure that the DC connectors are in perfect condition and that none of the DC conductors or DC plug contacts are exposed.
- Carefully release and remove the DC connectors as described in the following.

Procedure:

1. Release and remove the DC connectors. To do so, insert a flat-blade screwdriver or an angled screwdriver (blade width: 3.5 mm) into one of the side slots and pull the DC connectors out. When doing so, do not lever the DC connectors out, but insert the tool into one of the side slots only to release the locking mechanism, and do not pull on the cable.
2. Remove the DC connector swivel nut.

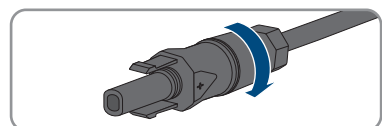
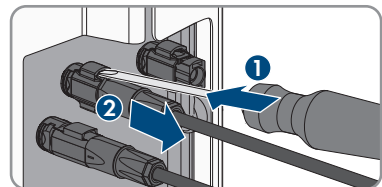

3. Unlock the DC connector. To do this, insert a flat-blade screwdriver (blade width: 3.5 mm) into the side catch mechanism and pry the catch mechanism open.

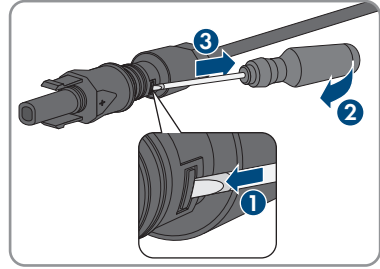

4. Carefully pull the DC connector apart.
5. Release the clamping bracket. To do so, insert a flat-blade screwdriver (blade width: 3.5 mm) into the clamping bracket and pry the clamping bracket open.

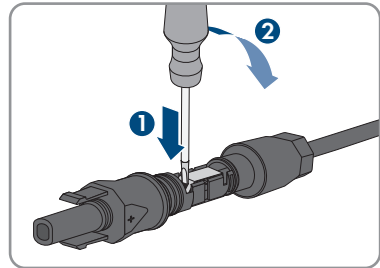

6. Remove the cable.

7 Commissioning

7.1 Commissioning Procedure

⚠ QUALIFIED PERSON

This section describes the commissioning procedure and gives an overview of the steps you must perform in the prescribed order.

i Commissioning a product in SMA Energy Systems

If the product is used in an SMA Energy System, the commissioning must be performed according to the manual of the SMA Energy System. The procedure and the sequence may differ from the steps described in this section.

- Commissioning an SMA Energy System (see system manual of the SMA Energy System).

i Commissioning an inverter that is captured in a communication device

When the inverter is captured in a communication device, the communication device (e.g. SMA Data Manager) is the unit for configuring the total system. The configuration is transferred to all inverters in the system. The system password assigned via the communication device is also the password for the user interface of the inverter.

- Commission the inverter (see Section 7.2, page 55).
- The initial configuration of the inverter is made via the communication device. The configuration is transferred to the inverter and the settings of the inverter are overwritten.
- Deactivate the Webconnect function of the inverter via the Sunny Portal. This prevents unnecessary connection attempts of the inverter with Sunny Portal.

i A country data set must be set for feed-in operation

From firmware version 3.13.##.R, the activation conditions for feed-in operation were changed.

To ensure the inverter begins feed-in operation during initial commissioning, a country data set must be set (for instance via the installation assistant on the user interface of the product, or via a communication product).

If no country data set is set, then feed-in operation will be stopped. This state is signaled by the green and red LEDs flashing simultaneously.

The inverter will automatically start feed-in operation only after the inverter configuration is completed.

Procedure	See
1. Commission the inverter.	Section 7.2, page 55

Procedure	See
2. Establish a connection to the user interface of the product. There are various connection options to choose from for this: <ul style="list-style-type: none"> • Direct connection via WLAN • Connection via WLAN in the local network • Connection via Ethernet in the local network 	Section 8.2, page 60
3. Log into the user interface.	Section 8.3, page 64
4. Select the inverter configuration option. Please note that the SMA Grid Guard code for changing the grid-relevant parameters must be available after completion of the first ten feed-in hours or installation assistant. You can request the SMA Grid Guard code via the Online Service Center.	Section 7.3, page 57
5. Configure the product and set country data set. Then the product will begin operation.	Section 8.13, page 75
6. Make further inverter settings as needed.	Section 8, page 60

7.2 Commissioning the Inverter

⚠ QUALIFIED PERSON

Requirements:

- The AC circuit breaker must be correctly rated and mounted.
- The product must be correctly mounted.
- All cables must be correctly connected.
- Unused enclosure openings must be sealed tightly with sealing plugs.

Procedure:

- To avoid invalid serial numbers from being sent to the data logger, commission the inverter without being connected to the local network first. To do this, ensure that the RJ45 connection to the network is not established.

- Position the enclosure lid of the AC-Connection Unit on the AC-Connection Unit and first tighten the upper-left and lower-right screws, and then the remaining screws crosswise (TX 25, torque: 6 Nm).

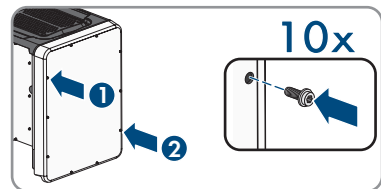

- Position the enclosure lid of the DC-Connection Unit on the DC-Connection Unit and first tighten the upper-left and lower-right screws, and then the remaining screws crosswise (TX 25, torque: 6 Nm).

4. Connect the DC connector to the inverter in its original position.

☑ The DC connectors snap into place.

5. Ensure that all DC connectors are securely in place.

6. Switch on the AC circuit breaker.

☑ All 3 LEDs light up. The start-up phase begins.

☑ All 3 LEDs go out again after approximately 90 seconds.

7. Turn the DC load-break switch of the inverter to position I.

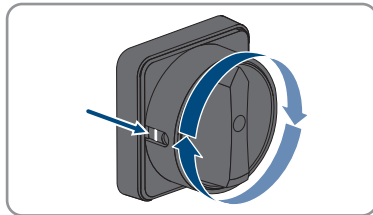

8. If the green and red LEDs flash simultaneously during initial commissioning, operation is stopped because no country data record has been set yet. For the inverter to begin operation, the configuration must be completed and a country data record must be set.

9. If the green LED is still flashing, the conditions for activating feed-in operation are not yet met. As soon as the conditions for feed-in operation are met, the inverter starts with feed-in operation and, depending on the available power, the green LED will light up continuously or it will pulse.

10. If the red LED lights up, an event has occurred. Find out which event has occurred and, if necessary, initiate countermeasures.

11. Ensure that the inverter feeds in correctly.

7.3 Selecting a configuration option

⚠ QUALIFIED PERSON

After you have assigned the password for the user groups **Installer** and **User** and logged in as **Installer**, the **Configuring the Inverter** page opens.

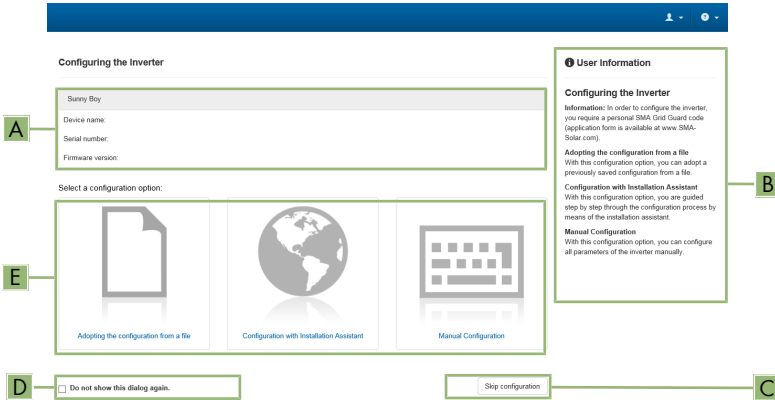

Figure 16: Layout of the **Configuring the Inverter** page

Position	Designation	Description
A	Device information	Provides the following information: <ul style="list-style-type: none"> • Device name • Inverter serial number • Inverter firmware version
B	User information	Provides brief information on the listed configuration options
C	Skip configuration	Offers the option of skipping the inverter configuration and go directly to the user interface (not recommended)
D	Checkbox	Allows you to choose not to have the displayed page displayed again when the user interface is called up again
E	Configuration options	Provides a selection of the various configuration options

Configuration options:

On the **Configuring the Inverter** page, different configuration options are available to choose from. Select one of the options and proceed for the selected option as described below. SMA Solar Technology AG recommends carrying out the configuration with the installation assistant. This way, you ensure that all relevant parameters are set for optimal inverter operation.

- Adoption of configuration from a file
- Configuration with the installation assistant (recommended)
- Manual configuration

Accepting the settings

Saving the made settings is indicated by an hourglass symbol on the user interface. If the DC voltage is sufficient, the data is transferred directly to the inverter and accepted. If the DC voltage is too low (e. g. in the evening), the settings are saved, but they cannot be directly transferred to or accepted by the inverter. As long as the inverter has not yet received and accepted the settings, the hourglass symbol will continue to be displayed on the user interface. The settings will be accepted when there is sufficient DC voltage applied and the inverter restarts. As soon as the hourglass symbol appears on the user interface, the settings have been saved. The settings will not be lost. You can log off of the user interface and leave the system.

Adopting the Configuration from a File

You can adopt the inverter configuration from a file. To do this, there must be an inverter configuration saved to a file.

Procedure:

1. Select the configuration option **Adopting configuration from a file**.
2. Select [**Browse...**] and select the desired file.
3. Select [**Import file**].

Configuring the Installation Assistant (Recommended)

1. Select the configuration option **Configuration with Installation Assistant**.
 - The installation assistant will open.
2. Follow the installation assistant steps and make the settings appropriate for your system.
3. For every setting made in a step, select [**Save and next**].
 - In the last step, all made settings are listed in a summary.
4. To correct settings you made, select [**Back**], navigate to the desired step, correct settings and select [**Save and continue**].
5. Once all settings are correct, select [**Next**] in the summary.
6. To save the settings to a file, select [**Export a summary**] and save the file on your smart device.
7. To export all parameters and their settings, select [**Export all parameters**]. This exports all parameters and their settings into an HTML file.
 - The start page of the user interface opens.

Manual configuration

You can configure the inverter manually by setting the desired parameters.

Procedure:

1. Select the configuration option **Manual Configuration**.
 - The **Device Parameters** menu on the user interface will open and all available parameter groups of the inverter will be displayed.
 2. Select [**Edit parameters**].
 3. Select the desired parameter group.
 - All available parameters of the parameter group will be displayed.
 4. Set the desired parameters.
 5. Select [**Save all**].
- The inverter parameters are set.

8 Operation

8.1 Activating and Operating the Display

You can activate and operate the display by tapping on the enclosure lid of the DC-Connection Unit.

Procedure:

1. Activate the display. Tap on the enclosure lid of the DC-Connection Unit once.
 - The backlight is switched on.
2. To move to the next message, tap on the enclosure lid of the DC-Connection Unit once.

8.2 Establishing a connection to the user interface

8.2.1 Establishing a Direct Connection via Ethernet

Requirements:

- The product must be commissioned.
- A smart device (e.g. laptop) with an Ethernet interface must be available.
- The product must be connected directly to the smart device.
- The respective latest version of one of the following web browsers must be installed on the smart device: Chrome, Edge, Firefox or Safari.
- The installer's SMA Grid Guard code must be available to change network-relevant settings after the first 10 hours of feed-in operation, or after completing the installation assistant. You can request the SMA Grid Guard code via the Online Service Center.

i IP address of the inverter

- Standard inverter IP address for the direct connection via Ethernet: **169.254.12.3**

Procedure:

1. Open the web browser of your smart device and enter the IP address **169.254.12.3** in the address bar.
 2. **i Web browser signals a security vulnerability**
 After the IP address has been entered, a message might appear indicating that the connection to the user interface of the product is not secure. SMA Solar Technology AG guarantees the security of the user interface.
 - Continue loading the user interface.
- The login page of the user interface opens.

8.2.2 Establishing a direct connection via WLAN

You have several options to connect the product to a smart device. The procedure can be different depending on the devices. If the procedures described do not apply to your device, establish the direct connection via Wi-Fi as described in the manual of your device.

The following connection options are available:

- Connection to SMA 360° App
- Connection with WPS
- Connection with Wi-Fi network search

Requirements:

- The product must be commissioned.
- A smart device (e.g. smartphone, tablet or laptop) must be available.
- The respective latest version of one of the following web browsers must be installed on the smart device: Chrome, Edge, Firefox or Safari.
- JavaScript must be enabled in the web browser of the smart device.
- The installer's SMA Grid Guard code must be available to change network-relevant settings after the first 10 hours of feed-in operation, or after completing the installation assistant. You can request the SMA Grid Guard code via the Online Service Center.

i SSID, IP address and WLAN password

- SSID in WLAN: **SMA[serial number]** (e.g. SMA0123456789)
- Device-specific WLAN password: see WPA2-PSK on the type label of the product or the rear side of the manual included in delivery
- Standard access address for a direct connection via WLAN outside of a local network: **https://smalogin.net** or **192.168.12.3**

i Importing and exporting files with smart devices having an iOS operating system is not possible

For technical reasons, importing and exporting files (e.g., importing an inverter configuration, saving the current inverter configuration or exporting events and parameters) is not possible with smart devices having an iOS operating system.

- Use a smart device that does not have an iOS operating system for importing and exporting files.

Connection to SMA 360° App

Requirements:

- A smart device with camera (e.g. smartphone or tablet) must be available.
- The SMA 360° App must be installed on the smart device.
- An user account for Sunny Portal must already exist.

Procedure:

1. Open the SMA 360° App and login with the Sunny Portal account details.
2. Select **QR-Code Scan** in the menu.

3. Scan the QR Code on you product via the SMA 360° App.
 - The smart device automatically connects to the product. The web browser of your smart device opens and the login page of the user interface is displayed.
4. If the web browser of the smart end device does not open automatically and the login page of the user interface is not displayed, open the web browser and enter **https://smalogin.net** in the address bar.

Connection with WPS

Requirement:

- The smart device must have a WPS function.

Procedure:

1. Enable the WPS function on the inverter. To do this, tap twice in succession on the enclosure lid of the DC-Connection Unit next to the LEDs.
 - The blue LED flashes quickly for approx. two minutes. The WPS function is active during this time.
2. Enable the WPS function on your smart device.
3. Open the web browser of your smart end device and enter **https://smalogin.net** in the address bar.

Connection with Wi-Fi network search

1. Search for Wi-Fi networks with your smart device.
2. Select the SSID of the product **SMA[serial number]** in the list with the detected Wi-Fi networks.
3. Enter the device-specific Wi-Fi password (see WPA2-PSK on the type label of the product or the rear side of the manual included in delivery).
4. Open the web browser of your smart end device and enter **https://smalogin.net** in the address bar.
 - The login page of the user interface is displayed.
5. If the login page of the user interface does not open, enter the IP address **192.168.12.3** or, if your smart end device supports mDNS services, **SMA[serial number].local** or **https://SMA[serial number]** in the address bar of the web browser.

8.2.3 Establishing a Connection via Ethernet in the local network

New IP address for connecting with a local network

If the product is connected to a local network (e.g. via a router), the product will receive a new IP address. Depending on the type of configuration, the new IP address will be assigned automatically by the DHCP server (router) or manually by you. Upon completion of the configuration, the product can only be reached via the following access addresses:

- Generally applicable access address: IP address manually assigned or assigned by the DHCP server (router) (identification via network scanner software or network configuration of the router).
- Access address for Apple and Linux systems: **SMA[serial number].local** (e.g. SMA0123456789.local)
- Access address for Windows and Android systems: **https://SMA[serial number]** (e.g. https://SMA0123456789)

Requirements:

- The product must be connected to the local network via a network cable (e.g. via a router).
- The product must be integrated into the local network. Tip: There are various methods of integrating the product into the local network with the aid of the installation assistant.
- A smart device (e.g. smartphone, tablet or laptop) must be available.
- The smart device must be in the same local network as the product.
- The respective latest version of one of the following web browsers must be installed on the smart device: Chrome, Edge, Firefox or Safari.
- The installer's SMA Grid Guard code must be available to change network-relevant settings after the first 10 hours of feed-in operation, or after completing the installation assistant. You can request the SMA Grid Guard code via the Online Service Center.

Procedure:

1. Open the web browser of your smart device. Enter the IP address of the product in the address bar of the web browser.
 2.  **Web browser signals a security vulnerability**

After the IP address has been entered, a message might appear indicating that the connection to the user interface of the product is not secure. SMA Solar Technology AG guarantees the security of the user interface.

 - Continue loading the user interface.
- The login page of the user interface opens.

8.2.4 Establishing a Connection via WLAN in the Local Network

i New IP address for connecting with a local network

If the product is connected to a local network (e.g. via a router), the product will receive a new IP address. Depending on the type of configuration, the new IP address will be assigned automatically by the DHCP server (router) or manually by you. Upon completion of the configuration, the product can only be reached via the following access addresses:

- Generally applicable access address: IP address manually assigned or assigned by the DHCP server (router) (identification via network scanner software or network configuration of the router).
- Access address for Apple and Linux systems: **SMA[serial number].local** (e.g. SMA0123456789.local)
- Access address for Windows and Android systems: **https://SMA[serial number]** (e.g. https://SMA0123456789)

Requirements:

- The product must be commissioned.
- The product must be integrated into the local network. Tip: There are various methods of integrating the product into the local network with the aid of the installation assistant.
- A smart device (e.g. smartphone, tablet or laptop) must be available.
- The smart device must be in the same local network as the product.
- The respective latest version of one of the following web browsers must be installed on the smart device: Chrome, Edge, Firefox or Safari.
- The installer's SMA Grid Guard code must be available to change network-relevant settings after the first 10 hours of feed-in operation, or after completing the installation assistant. You can request the SMA Grid Guard code via the Online Service Center.

i Importing and exporting files with smart devices having an iOS operating system is not possible

For technical reasons, importing and exporting files (e.g., importing an inverter configuration, saving the current inverter configuration or exporting events and parameters) is not possible with smart devices having an iOS operating system.

- Use a smart device that does not have an iOS operating system for importing and exporting files.

Procedure:

- Enter the IP address of the product in the address bar of the web browser.
 - The login page of the user interface opens.

8.3 Logging In and Out of the User Interface

After a connection to the user interface of the inverter has been established, the login page opens. Log onto the user interface as described below.

Usage of cookies

For the correct display of the user interface, cookies are required. The cookies are used for convenience only. By using this user interface you agree to the placement of cookies.

Log in as Installer or User for the First Time

Password assignment for user and installer

The passwords for the user groups **Installer** and **User** must be assigned when accessing the user interface for the first time. If the inverter was registered in a communication device (e.g., SMA Data Manager) and the system password was assigned, the system password is also the installer password. In this case, only the user password must be assigned.

- If you as a specialist assign the user password, only pass the password on to persons to access the inverter data via the user interface.
- If you as a user assign the installer password, only pass the password on to persons to receive access to the system.

Installer password for inverters registered in a communication device or in Sunny Portal

To be able to register the inverter in a communication device (e.g., SMA Data Manager) or in a Sunny Portal system, the password for the user group **Installer** must match the system password. If you assign a password for the user group **Installer** via the user interface of the inverter, the same password must also be used as the system password.

- Assign a uniform installer password to all SMA devices in the system.

Procedure:

1. In the drop-down list **Language**, select the desired language.
 2. In the **Password** field, enter a password for the **User** user group.
 3. In the **Repeat password** field, enter the password again.
 4. Click on **Save**.
 5. In the **New password** field, enter a password for the **Installer** user group. Assign a uniform password to all SMA devices to be registered in a system. The installer password is also the system password.
 6. In the **Repeat password** field, enter the password again.
 7. Click on **Save and log in**.
- The **Configuring the Inverter** page opens.

Log in as the User or Installer

1. In the drop-down list **Language**, select the desired language.
 2. In the **User group** drop-down list, select the entry **Installer** or **User**.
 3. Enter the password in the field **Password**.
 4. Select **Login**.
- The start page of the user interface opens.

Log Out as the User or Installer

1. On the right-hand side of the menu bar, select the menu **User Settings**.
 2. In the subsequent context menu, select [**Logout**].
- The login page of the user interface opens. The logout was successful.

8.4 Start Page Design of the User Interface

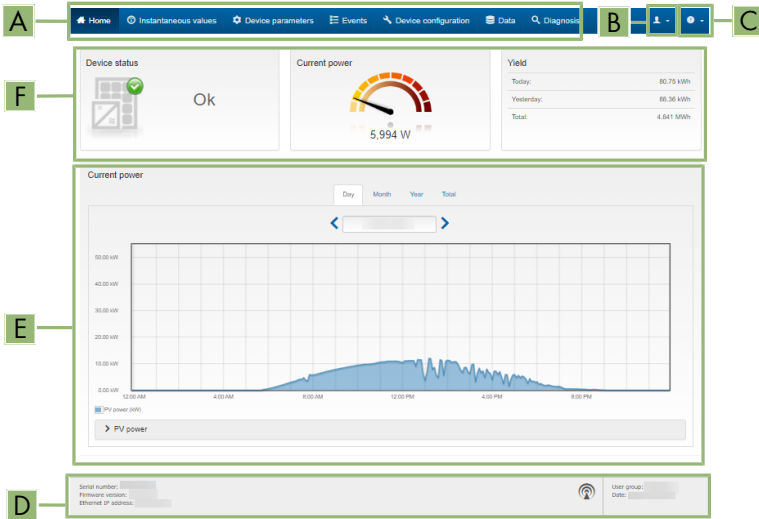

Figure 17: Design of the user interface's home page (example)

Position	Designation	Description
A	Menu	<p>Provides the following functions:</p> <ul style="list-style-type: none"> • Home Opens the user interface home page • Instantaneous values Current measured values of the inverter • Device Parameters The various operating parameters of the inverter can be viewed and configured here depending on the user group. • Events All events that have occurred in the selected time period are displayed here. The event types are Information, Warning and Error. Currently existing events of the types Error and Warning will be additionally displayed in the Device status viewlet. However, only the higher-priority event is displayed. If, for example, there is a Warning and an Error present at the same time, only the error will be displayed. • Device Configuration Various settings for the inverter can be made here. The selection available is dependent on which user group you are logged in as and the operating system of the device with which the user interface has been called up. • Data You will find all data that is saved in the internal memory of the inverter or on an external storage medium on this page. • Diagnosis Here, an I-V characteristic curve of the PV array per MPP tracker can be created and exported.
B	User settings	<p>Provides the following functions, depending on the user group logged in:</p> <ul style="list-style-type: none"> • Starting the installation assistant • SMA Grid Guard login • Logout
C	Help	<p>Provides the following functions:</p> <ul style="list-style-type: none"> • Displaying information on Open Source licenses used • Link to the website of SMA Solar Technology AG

Position	Designation	Description
D	Status bar	<p>Displays the following information:</p> <ul style="list-style-type: none"> • Inverter serial number • Inverter firmware version • IP address of the inverter within the local network and/or IP address of the inverter during WLAN connection • With WLAN connection: Signal strength of WLAN connection • User group logged in • Date and device time of the inverter
E	Current power and current consumption	<p>Temporal progression of the PV power and the power consumption of the household over the selected time period. Please note, the power consumption will only be displayed if an energy meter is installed in the PV system.</p>
F	Status display	<p>The various areas display information on the current status of the PV system.</p> <ul style="list-style-type: none"> • Device status Displays whether the inverter is currently in a fault-free operating state or whether there is an Error or Warning present. • Current power Displays the power currently being generated by the inverter. • Yield Displays the energy yield of the inverter. • Grid supply Displays the energy supply from the utility grid. • Power at the grid-connection point Indicates which power is currently fed in or obtained at the grid-connection point. • Irradiation / wind speed Depending on the connected sensors, displays the current solar irradiation and/or wind speed. • Temperature measurement Depending on the connected sensors, displays the current temperature of the PV modules and/or the ambient temperature.

8.5 Displaying and Downloading the Stored Data

If an external storage device is plugged in, you can display and download the stored data.

Procedure:

1. Activate the user interface (see Section 8.2, page 60).
2. Log into the user interface (see Section 8.3, page 64).
3. Select the menu **Data**.
4. Select the folder **Data**.
5. To call up the data, select the respective folder and click on the required file.
6. To download the data, select the data type to be exported in the drop-down list. Then apply the time filter and select **Data export**.

8.6 Activating the Smart Inverter Screen

With the Smart Inverter Screen, the most important inverter data is displayed directly on the user interface login page. To activate the Smart Inverter Screen, proceed as listed in the following.

Procedure:

1. Activate the user interface (see Section 8.2, page 60).
 2. Log in as **Installer** or **User**.
 3. Select the menu **User Settings** (see Section 8.4, page 67) on the start page of the user interface.
 4. Select [**Smart Inverter Screen**].
- The Smart Inverter Screen has been activated.

8.7 Starting the Installation Assistant

QUALIFIED PERSON

The installation assistant leads you step-by-step through the steps necessary for the initial configuration of the inverter.

Layout of the installation assistant

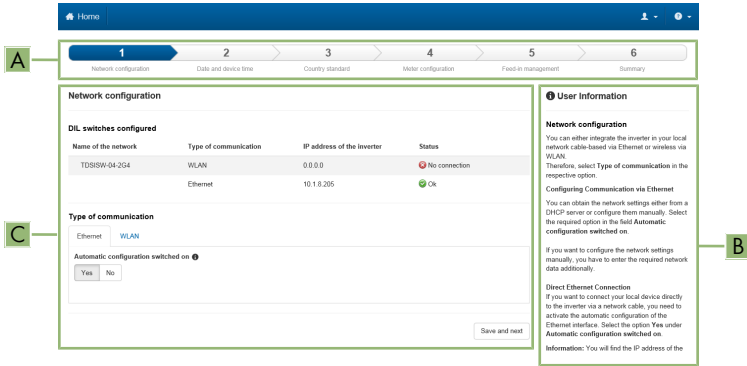

Figure 18: Layout of the installation assistant (example)

Position	Designation	Description
A	Configuration steps	Overview of the installation assistant steps. The number of steps depends on the type of device and the additionally installed modules. The current step is highlighted in blue.
B	User information	Information about the current configuration step and the setting options of the configuration step.
C	Configuration field	You can make settings in this field.

Requirement:

- The SMA Grid Guard code must be available to change network-relevant parameters after the first 10 hours of feed-in operation, or after completing the installation assistant. You can request the SMA Grid Guard code via the Online Service Center.

Procedure:

1. Open the user interface (see Section 8.2, page 60).
 2. Log in as **Installer**.
 3. Select the menu **User Settings** (see Section 8.4, page 67) on the start page of the user interface.
 4. In the context menu, select **[Starting the installation assistant]**.
- The installation assistant will open.

8.8 Activate WPS Function

The WPS function can be used for different purposes:

- Automatic connection to a network (e.g. via router)
- Direct connection between the product and a smart device

Depending on the intended application of the WPS function, the procedure for activation will vary.

Activating WPS function for automatic connection to a network

Requirements:

- WLAN must be activated in the product.
- WPS must be activated on the router.

Procedure:

1. Open the user interface (see Section 8.2, page 60).
 2. Log in as **Installer**.
 3. Start the installation assistant (see Section 8.7, page 70).
 4. Select **Network configuration**.
 5. Select **WPS for WLAN network** button in the **WLAN** tab.
 6. Select **Activate WPS**.
 7. Select **Save and next** and exit the installation assistant.
- The WPS function is activated and the automatic connection to the network can be established.

Activating the WPS function for direct connection to the smart device.

- Activate the WPS function on the inverter. To do this, tap twice in succession on the enclosure lid of the DC-Connection Unit next to the LEDs.
 - The blue LED flashes quickly for approx. two minutes. The WPS function is active during this time.

8.9 Switching WLAN On and Off

The inverter is equipped with an activated WLAN interface as standard. If you do not want to use WLAN, you can switch the WLAN function off and switch it on again whenever needed. In doing so, you can switch the WLAN direct connection and the WLAN connection in the local network on independently of each other.

i Switching on the WLAN function only possible via Ethernet connection

If you switch off both the WLAN function for the direct connection and for the connection in the local network, access to the inverter user interface and therefore reactivation of the WLAN interface is only possible via an Ethernet connection.

The basic procedure for changing operating parameters is explained in another section (see Section 8.12 "Changing Operating Parameters", page 74).

Switching WLAN Off

If you would like to switch the WLAN function off completely, you must switch off both the direct connection and the connection in the local network.

Procedure:

- To switch off the direct connection in the parameter group **PV system communication > WLAN**, select the parameter **Soft-access-point is turned on** and set this to **No**.

- To switch off the connection in the local network in the parameter group **PV system communication > WLAN**, select the parameter **WLAN is turned on** and set this to **No**.

Switching WLAN On

If you have switched the WLAN function for direct connection or for connection in the local network off, you can switch the WLAN function back on in accordance with the following procedure.

Requirement:

- If the WLAN function was previously switched off completely, the inverter must be connected to a computer or router via Ethernet.

Procedure:

- To switch on the WLAN direct connection, in the parameter group **PV system communication > WLAN**, select the parameter **Soft-access-point is turned on** and set this to **Yes**.
- To switch on the WLAN connection in the local network, in the parameter group **System communication > WLAN**, select the parameter **WLAN is turned on** and set this to **Yes**.

8.10 Switching the Dynamic Power Display Off

As standard, the product signals its power dynamically via the pulsing of the green LED. When doing so, the LED flashes on and off uniformly or is permanently lit at full power. The various gradations are related here to the set active power limit of the product. If this display is not desired, switch this function off in accordance with the following procedure. Once this has been done, the green LED is lit permanently to signalize feed-in operation.

The basic procedure for changing operating parameters is explained in another section (see Section 8.12 "Changing Operating Parameters", page 74).

Procedure:

- In the parameter group **Device > Operation**, select the parameter **Dynamic power display via green LED** and set this to **Off**.

8.11 Changing the Password

The password for the product can be changed for both user groups. Furthermore, the user group **Installer** can change the password for the user group **User** as well as its own password.

PV systems registered in a communication product

With PV systems that are registered in a communication product (e.g. Sunny Portal, Cluster Controller), you can also assign a new password for the user group **Installer** via the communication product. The password for the user group **Installer** is also the system password. If you assign a password for the user group **Installer** via the user interface of the inverter that does not correspond to the system password in the communication product, the inverter can no longer be reached by the communication product.

- Ensure that the password for the user group **Installer** is the same as the system password in the communication product.

Procedure:

1. Open the user interface (see Section 8.2, page 60).
2. Log into the user interface (see Section 8.3, page 64).
3. Call up the menu **Device parameters**.
4. Click on [**Edit parameters**].
5. In the parameter group **User Rights > Access Control** change the password of the desired user group.
6. Select [**Save all**] to save the changes.

8.12 Changing Operating Parameters

The operating parameters of the inverter are set to certain values by default. You can change the operating parameters to optimize the performance of the inverter.

This section describes the basic procedure for changing operating parameters. Always change operating parameters as described in this section.

Some function-sensitive parameters can only be viewed by qualified persons and can only be changed by qualified persons by entering the personal SMA Grid Guard code. You can request the SMA Grid Guard code via the Online Service Center.

Requirements:

- Changes to grid-relevant parameters must be approved by the responsible grid operator.

Procedure:

1. Open the user interface (see Section 8.2, page 60).
 2. Log into the user interface (see Section 8.3, page 64).
 3. Call up the menu **Device parameters**.
 4. Click on [**Edit parameters**].
 5. Log in using the SMA Grid Guard code to change those parameters designated by a lock (only for installers):
 - Select the menu **User settings** (see Section 8.4, page 67).
 - In the subsequent context menu, select [**SMA Grid Guard login**].
 - Enter the SMA Grid Guard code and select [**Login**].
 6. Expand the parameter group that contains the parameter which is to be configured.
 7. Change the required parameters.
 8. Select [**Save all**] to save the changes.
- The parameters are set.

i Accepting the settings

Saving the made settings is indicated by an hourglass symbol on the user interface. If the DC voltage is sufficient, the data is transferred directly to the inverter and accepted. If the DC voltage is too low (e. g. in the evening), the settings are saved, but they cannot be directly transferred to or accepted by the inverter. As long as the inverter has not yet received and accepted the settings, the hourglass symbol will continue to be displayed on the user interface. The settings will be accepted when there is sufficient DC voltage applied and the inverter restarts. As soon as the hourglass symbol appears on the user interface, the settings have been saved. The settings will not be lost. You can log off of the user interface and leave the system.

8.13 Configuring the Country Data Set

⚠ QUALIFIED PERSON

For the product to begin operation, a country data set must be set (for instance via the installation assistant on the user interface of the product, or via a communication product). As long as no country data set is set, operation of the product will remain stopped. This state is signaled by the green and red LEDs flashing simultaneously. Once configuration of the product is completed, the product will start operating automatically.

By default, the inverter is set to a universally valid country data set. You must adjust the country data set for the installation site.

i The country data set must be set correctly.

If you select a country data set which is not valid for your country and purpose, it can cause a disturbance in the PV system and lead to problems with the grid operator. When selecting the country data set, you must always observe the locally applicable standards and directives as well as the properties of the PV system (e.g. PV system size, grid-connection point).

- If you are not sure which standards and directives are valid for your country or purpose, contact the grid operator.

i Change to the names and units of grid parameters to comply with the grid-connection requirements in accordance with Regulation (EU) 2016/631 (valid from April 27, 2019)

To comply with the EU grid-connection requirements (valid from April 27, 2019) the names and units of grid parameters were changed. This change is valid from firmware version $\geq 3.00.00.R$ if a country data set for fulfilling the EU grid-connection requirements (valid from 2019-04-27) is set. Names and units of grid parameters for inverters with firmware version $\leq 2.99.99.R$ are not affected by this change and remain valid. This also applies from firmware version $\geq 3.00.00.R$ if a country data set that is valid for countries outside the EU is set.

The basic procedure for changing operating parameters is explained in another section (see Section 8.12 "Changing Operating Parameters", page 74).

Procedure:

- In the parameter group **Grid monitoring > Grid monitoring** select the parameter **Set country standard** and set the required country data set.

8.14 Configuring the Active Power Mode

⚠ QUALIFIED PERSON

Starting the installation assistant

1. Open the user interface (see Section 8.2, page 60).
2. Log in as **Installer**.
3. Start the installation assistant (see Section 8.7, page 70).
4. Select [**Save and continue**] after each step up until the step **Grid management service**.
5. Make the settings as described in the following.

Make the settings for systems with external setpoint

1. In the tab **Active power mode** set the switch **Active power setpoint** to [**On**].
2. In the drop-down list **Operating mode active power setpoint**, select the entry **External setpoint**.
3. In the drop-down list **Fallback behavior**, select the entry **Apply fallback values**.
4. In the field **Fallback value of the maximum active power** enter the value to which the inverter is to limit its nominal power in case of a communication failure to the higher control unit at the end of the timeout time.
5. In the field **Timeout**, enter the time that the inverter is to wait before it limits its nominal power to the set fallback value.
6. If, in the event of a 0% or 0 W specification, the inverter is not permitted to feed small amounts of active power into the utility grid, select the entry **Yes** in the drop-down list **Grid disconnection for 0% active power setpoint**. This ensures that in the event of a 0% or 0 W specification, the inverter disconnects from the utility grid and does not feed in active power.

Make the settings for systems with manual setpoint

1. In the tab **Active power mode** set the switch **Active power setpoint** to [**On**].
2. Select the entry **Manual setpoint in %** or **Manual setpoint in W** for manual specification and enter the respective setpoint value.

8.15 Configuring Q on Demand 24/7

With the "Q on Demand 24/7" function, the inverter remains connected to the utility grid overnight and is supplied with power via the utility grid in order that it can provide reactive power. When connected overnight, the inverter only draws an insignificant amount of active power from the utility grid to supply its internal assemblies. The inverter can provide up to 100% of its power as reactive power. The provision of reactive power during feed-in operation leads to a reduction of the feed-in power. This means that at 100% reactive power, the feed-in power is 0%.

The general setting of the grid management services (e.g. $\cos \phi$ setpoint or Q(V) characteristic curve) can not be fully set independently of the "Q on Demand 24/7" function via the relevant parameters - "Q on Demand 24/7" only permits Q specifications. It is to be noted here that certain settings can have an influence on other grid-support settings and functions.

This means that if the "Q on Demand 24/7" function" is active, no other grid-supporting functions (e.g., cos phi) are possible between day and night operation of the inverter. Should an independent reactive power provision be desired between day- and night operation, the reactive power provision must be communicated to the inverter via a superordinate control unit.

Currently, the provision of reactive power can only be read off via the phase currents and phase voltages in the instantaneous values (**Instantaneous values > AC Side > Phase currents / Phase voltage**) or requested via Modbus.

The basic procedure for changing operating parameters is explained in another section (see Section 8.12 "Changing Operating Parameters", page 74).

Procedure:

1. Select the parameter **Reactive power mode in case of active power output** and set the desired procedure. When doing so, note that for "Q on Demand 24/7", the modes **Cos Phi(P) characteristic curve** or **Cos Phi(U) characteristic curve** may not be selected.
2. Select the parameter **Reactive power mode in case of zero active power** and set the desired procedure.
3. Set the parameters associated with the reactive power mode.

8.16 Changing the Operating Mode of the Multifunction Relay

QUALIFIED PERSON

The default operating mode of the multifunction relay is **Fault indication (FltInd)** . If you decide to use another operating mode and have established the correct electrical connection for this operating mode and the associated connection variant, you will have to change the operating mode of the multifunction relay and make other settings, if necessary.

The basic procedure for changing operating parameters is explained in another section (see Section 8.12 "Changing Operating Parameters", page 74).

Procedure:

1. Call up the menu **Device Parameters**.
2. Select [**Edit parameters**].
3. In the parameter group **Device > Multifunction relay > Operating mode** select the parameter **Operating mode of multifunction relay** or **Mlt.OpMode** and set the desired operating mode.
4. Once you have set the operating mode **Self-consumption** or **SelfCsmP**, you can configure other settings:
 - In the parameter group **Device > Multifunction relay > Self-consumption > Minimum On power** select the parameter **Minimum On power for MFR self-consumption** or **Mlt.MinOnPwr** and set the desired value. This will configure the power threshold from which a load is to be activated.

- In the parameter group **Device > Multifunction relay > Self-consumption > Minimum power On time** select the parameter **Minimum power On time, MFR self-consumption** or **Mlt.MinOnPwrTmm** and set the desired value. This will configure the minimum time for which the power must have exceeded the minimum switch-on power threshold in order to trip activation of the load.
 - In the parameter group **Device > Multifunction relay > Self-consumption > Minimum On power** select the parameter **Minimum On time for MFR self-consumption** or **Mlt.MinOnTmm** and set the desired value. This will configure the minimum time for which the load remains activated.
5. If you have set the operating mode **Control via communication** or **ComCtl**, in the parameter group **Device > Multifunction relay > Control via communication > Status** select the parameter **Status of MFR with control via communication** or **Mlt.ComCtl.Sw** and set the desired value. This determines whether the multifunction relay can be controlled via a communication product.
 6. If you have set the operating mode **Battery bank** or **BatCha**, make further settings:
 - In the parameter group **Device > Multifunction relay > Battery bank > Minimum On power** select the parameter **Minimum On power for MFR battery bank** or **Mlt.BatCha.Pwr** and set the desired value. This will configure the power threshold from which the battery is to be charged.
 - In the parameter group **Device > Multifunction relay > Battery bank > Minimum time before reconnection** select the parameter **Minimum time before reconnection of MFR battery bank** or **Mlt.BatCha.Tmm** and set the desired value. This will configure the minimum time which must elapse after charging the battery before the battery can be charged again.
 7. Select [**Save all**] to save the changes.

8.17 Configuring the Modbus Function

QUALIFIED PERSON

The Modbus interface is deactivated by default and the communication ports 502 set.

In order to access SMA inverters with SMA Modbus® or SunSpec® Modbus®, the Modbus interface must be enabled. After enabling the interface, the communication ports of both IP protocols can be changed. For information on commissioning and configuration of the Modbus interface, see the technical information "SMA and SunSpec Modbus® Interface" at www.SMA-Solar.com.

For information on which Modbus registers are supported, see the technical information "Modbus® parameters and measured values" at www.SMA-Solar.com.

Measures for data security during activated Modbus interface

If you activate the Modbus interface, there is a risk that unauthorized users may access and manipulate the data or devices in your PV system.

To ensure data security, take appropriate protective measures such as:

- Set up a firewall.
- Close unnecessary network ports.
- Only enable remote access via VPN tunnel.
- Do not set up port forwarding at the communication port in use.
- In order to deactivate the Modbus interface, reset the inverter to the default settings or deactivate the activated parameter again.

Procedure:

- Activate the Modbus interface and adjust the communication ports if necessary (see the technical information "SMA and SunSpec Modbus® Interface" at www.SMA-Solar.com).

8.18 Activating the Receipt of Control Signals (Only for Italy)

QUALIFIED PERSON

In order for PV systems in Italy to receive control commands from the grid operator, set the following parameters.

The basic procedure for changing operating parameters is explained in another section (see Section 8.12 "Changing Operating Parameters", page 74).

Parameter	Value/range	Resolution	Default
Application ID	0 to 16384	1	16384
GOOSE-Mac address	01:0C:CD:01:00:00 to 01:0C:CD:01:02:00	1	01:0C:CD:01:00:00

Procedure:

1. Select the parameter group **External communication > IEC 61850 configuration**.
 2. In the field **Application ID**, enter the application ID of the grid operator gateway. You will receive this value from your grid operator. You can enter a value between 0 and 16384. The value 16384 indicates "deactivated".
 3. In the field **GOOSE-Mac address**, enter the MAC address of the grid operator gateway from which the inverter is to receive the control commands. You will receive this value from your grid operator.
- The receipt of control signals from the grid operator is activated.

8.19 Setting SMA ShadeFix

QUALIFIED PERSON

You can set the time interval in which the inverter has to determine the optimum operating point. If you do not want to use SMA ShadeFix, you can disable the feature.

The basic procedure for changing operating parameters is explained in another section (see Section 8.12 "Changing Operating Parameters", page 74).

Procedure:

- In the parameter group **DC-side > DC settings > SMA ShadeFix**, set the parameter **Time interval of SMA ShadeFix** and set the required time interval. The ideal time interval is usually six minutes. This value should only be increased if the shading situation changes extremely slowly.
 - The inverter optimizes the MPP of the PV system at the predetermined time interval.
- In order to disable the SMA ShadeFix feature, in the parameter group **DC-side > DC settings > SMA ShadeFix**, set the parameter **SMA ShadeFix switched on** to **Off**.

8.20 Generating the I-V Characteristic Curve

QUALIFIED PERSON

Only the STP 50-41 is equipped with this function.

During the measurement, the inverter can briefly interrupt the feed-in or feed in with reduced power. The duration of a measurement is approx. 20 seconds per MPP tracker. To avoid misuse of the function and thus yield loss, the measurement can be carried out a maximum of 10 times per day. If more than 10 measurements per day are to be carried out, the inverter must be restarted.

The measuring curve has over 200 measuring points. The display is from 0 V up to the maximum MPP voltage of the inverter. The current is limited by the maximum possible input current of the inverter.

The data is stored on the user interface until the next measurement.

Further information as well as help for the interpretation of the I-V-characteristic curve can be found in the technical information "I-V diagnostic function: Determination of the generator characteristic curve by the inverter for fault detection in the PV array".

Using the function when using external module optimizers is not recommended.

Using the function when using external module optimizers does not produce interpretable results and is therefore not recommended.

Requirements:

- In order to avoid misinterpretation of the determined characteristic curve at low powers, a measurement should be carried out at at least 50% of the inverter's nominal power.
- In the case of comparative measurements (e.g. at annual intervals), similar ambient conditions (solar irradiation, shading, temperature) should prevail.

Procedure:

1. Log on to the user interface of the inverter.
2. Click on **Diagnosis** in the menu.
3. Select the required MPP tracker.
4. Click on [**Start new measurement**].
5. Go to [**PDF export**] or [**CSV export**] to export the data shown.

8.21 Setting the Rated Residual Current of the Residual-Current Device

QUALIFIED PERSON

When using residual-current devices with a rated residual current of < 500 mA, set the rated residual current to the respective value in the inverter. In this way the inverter reduces the operational leakage currents and prevents a false triggering of the residual-current device (further information see technical information "Leading Leakage Currents" at www.SMA-Solar.com).

The basic procedure for changing operating parameters is explained in another section (see Section 8.12 "Changing Operating Parameters", page 74).

Procedure:

- In the parameter group **Device > Inverter**, select the parameter **RCD adjustment** and set it to the rated residual current of the residual-current device that is used.

8.22 Activating or Deactivating the Arc-Fault Circuit Interrupter (AFCI)

QUALIFIED PERSON

Only the STP 50-41 is equipped with this function.

The arc-fault circuit interrupter can be activated with or without operation inhibition or deactivated. The procedure for activating or deactivating the AFCI may differ depending on the year in the name of the country data set.

The basic procedure for changing operating parameters is explained in another section (see Section 8.12 "Changing Operating Parameters", page 74).

Deactivating the Arc-Fault Circuit Interrupter (AFCI)

Procedure:

- In the parameter group **Device > Inverter**, select the parameter **AFCI switched on or AfcilsOn** and set to **No**.

Activating the Arc-Fault Circuit Interrupter (AFCI) with Operation Inhibition

When the arc-fault circuit interrupter is active and an electric arc is detected, the inverter interrupts the feed-in operation and an operation inhibition occurs. The operation inhibition must be reset manually if the inverter is to feed into the grid again (see Section 11.4, page 110).

Procedure for country data sets without year or with year < 2018:

- In the parameter group **Device > Inverter**, select the parameter **AFCI switched on** or **AfcilsOn** and set to **Yes**.

Procedure for country data sets with year ≥ 2018:

1. In the parameter group **Device > Inverter**, select the parameter **AFCI switched on** or **AfcilsOn** and set to **Yes**.
2. In the parameter group **AC Side > Operation > Manual restart**, set the parameter **Activated** or **ManRstr.IsOn** to **Yes**.
3. Select the parameter **After arc fault detection** or **ManRstr.ManRstrAFCI** and set it to **On**.

Activating the Arc-Fault Circuit Interrupter (AFCI) without Operation Inhibition

When the arc-fault circuit interrupter without operation inhibition is active and an electric arc is detected, the inverter interrupts the feed-in operation. No operation inhibition occurs. After a waiting period, the inverter starts automatically and checks whether the electric arc is still present. If the electric arc is still present, the inverter disconnects from the grid again and the process is repeated.

Procedure for country data sets without year or with year < 2018:

- In the parameter group **Device > Inverter**, select the parameter **AFCI switched on** or **AfcilsOn** and set to **Yes, without permanent operation inhibition**.

Procedure for country data sets with year ≥ 2018:

1. In the parameter group **Device > Inverter**, select the parameter **AFCI switched on** or **AfcilsOn** and set to **Yes**.
2. In the parameter group **AC Side > Operation > Manual restart**, select the parameter **After arc fault detection** or **ManRstr.ManRstrAFCI** and set it to **Off**. The parameter **Activated** or **ManRstr.IsOn** can only be set to **No** if all parameters in the group **Manual restart** are set to **Off**.

8.23 Activating and Setting String-Failure Detection

⚠ QUALIFIED PERSON

If you would like to use the string-failure detection, you will have to activate it.

You have the option of combining inputs with the same properties (e.g. shading, alignment or module type) in a group. A total of 3 groups are available. At least 2 inputs must be assigned per group.

You must set the sensitivity and tolerance for string-failure detection. You must also set the minimum time for which the tolerance must be exceeded before the inverter reports an event.

You can also set the activation threshold for string-failure detection to avoid an erroneous event message. In systems with a very inhomogeneous alignment of the PV modules, events of too low DC voltage or too low DC current can occur relatively frequently. If you increase the activation threshold, make sure that the string-failure detection only becomes active when there is sufficient DC power. In this way, you avoid erroneous event messages under unfavorable irradiation conditions.

You can carry out the activation and setting of the string-failure detection via the device parameters or using the installation assistant.

The activation threshold for the string-failure detection can only be set via the device parameters. The activation threshold is set to 20% of the inverter's nominal power by default.

Settings via device parameters

In the following table, you will find all parameters that are needed to activate and set the string-failure detection.

Object name	Parameter	Display group	Settings
Operation.StrFlt-Det.OpMod	Operating mode of the string-failure detection	DC side > Operation > String-failure detection > General operating mode	<ul style="list-style-type: none"> Off On
Operation.StrFlt-Det.ChGrp	String comparison group for string-failure detection	DC side > Operation > String-failure detection > Comparison group	<ul style="list-style-type: none"> No Group (NoGrp) Group 1 (Grp1) Group 2 (Grp2) Group 3 (Grp3)
Operation.StrFlt-Det.SnsLvl	Sensitivity of string-failure detection	DC side > Operation > String-failure detection > Sensitivity of the sensors	<ul style="list-style-type: none"> Special setting (Adj) Low (LowMod) Normal (NrmMod) High (HiMod)
Operation.StrFlt-Det.Tol	Tolerance of string-failure detection	DC side > Operation > String-failure detection > Tolerance	<ul style="list-style-type: none"> 0% to 100%
Operation.StrFlt-Det.WrnTm	Time until string-failure detection warning	DC side > Operation > String-failure detection > Time until warning	<ul style="list-style-type: none"> 5 min to 360 min
Operation.StrFlt-Det.WMinNom	Activation threshold for string-failure detection*	DC side > Operation > String-failure detection > Nominal AC power	<ul style="list-style-type: none"> 5% to 100%

* Parameter can exclusively be set via the device parameters.

Procedure:

1. Activate the user interface of the inverter.
2. Log into the user interface as an **Installer**.
3. Call up the menu **Device parameters**.
4. Click on **[Edit parameters]**.
5. Expand the display group that contains the parameter.
6. Set the parameter.
7. Select **[Save all]** to save the settings.

Configuration with the help of the installation assistant

Procedure:

1. Open the user interface (see Section 8.2, page 60).
2. Log into the user interface as an **Installer**.
3. On the right-hand side of the menu bar, select the menu **User Settings** (see Section 8.4 "Start Page Design of the User Interface", page 67).
4. In the context menu, select [**Starting the installation assistant**].
5. Select [**Save and next**] until you reach the **String configuration** step.
6. Activate string-failure detection and making settings.
7. Select [**Save and next**].

8.24 Saving the Configuration in a File

You can save the current configuration of the inverter in a file. You can use this file as a data backup for this inverter and then import this file into this inverter again or another inverter from the same type or device family to configure the inverter. When saving, only the device parameters will be saved, not any passwords.

Procedure:

1. Open the user interface (see Section 8.2, page 60).
2. Log into the user interface (see Section 8.3, page 64).
3. Select the menu **Device Configuration**.
4. Select [**Settings**].
5. In the context menu, select [**Saving the configuration in a file**].
6. Follow the instructions in the dialog.

8.25 Adopting a Configuration from a File

QUALIFIED PERSON

To configure the inverter, you can adopt the configuration from a file. To be able to do this, you must first save the configuration of another inverter from the same type or device family in a file (see Section 8.24 "Saving the Configuration in a File", page 84). When saving, only the device parameters will be adopted, not any passwords.

Requirements:

- Changes to grid-relevant parameters must be approved by the responsible grid operator.
- The SMA Grid Guard code must be available. You can request the SMA Grid Guard code via the Online Service Center.

Procedure:

1. Open the user interface (see Section 8.2, page 60).
2. Log into the user interface as an **Installer** (see Section 8.3, page 64).
3. Select the menu **Device Configuration**.

4. Select [**Settings**].
5. In the context menu, select [**Adopting the configuration from a file**].
6. Follow the instructions in the dialog.

8.26 Firmware Update

You can activate an automatic firmware update in the inverter or in the communication product.

If no automatic update is set for the inverter in the communication product (e.g. SMA Data Manager, Cluster Controller, Sunny Portal) or via the user interface of the inverter, you have the option of carrying out a manual firmware update.

You have the following options to update the firmware:

- Automatic Firmware Update (Recommended)
- Update the firmware with the existing update file via the user interface of the inverter.
- Update the firmware with the existing update file via USB flash drive.
- Search and install the firmware via the user interface of the inverter.

8.26.1 Activating Automatic Firmware Update

QUALIFIED PERSON

You can activate the automatic firmware update in the inverter or in the communication product.

If the automatic firmware update is activated in the inverter, the inverter searches for updates and carries out the update.

If the automatic firmware update is activated in the communication product, the communication product searches for updates for the inverter and carries out the update of the inverter. In this case, the automatic firmware update is deactivated by default in the inverter. This prevents multiple downloads of updates.

In this section we describe how to activate the automatic firmware update in the inverter. The procedure for activating the automatic firmware update for detected devices in the communication product can be found in the manual for the communication product.

The basic procedure for changing operating parameters is explained in another section (see Section 8.12 "Changing Operating Parameters", page 74).

Procedure:

- In the parameter group **Device > Update**, select the **Automatic Update** parameter and set to **Yes**.

8.26.2 Updating Firmware with Update File via the User Interface

QUALIFIED PERSON

Requirements:

- An update file with the desired firmware of the product must be available. You can download the update file from the product page under www.SMA-Solar.com.

Procedure:

1. Open the user interface (see Section 8.2, page 60).
2. Log into the user interface as an **Installer** (see Section 8.3, page 64).
3. Click on **[Edit parameters]**.
4. Select the menu **Device Configuration**.
5. In the product row, click on the gear icon and select **Update firmware**.
6. Select **[Browse]** and select the update file for the product.
7. Select **Update firmware**.
8. Follow the instructions in the dialog.
9. Open the user interface and check the events to see whether the firmware update has been completed successfully.

8.26.3 Updating Firmware with Update File via the USB Flash Drive

QUALIFIED PERSON

Requirement:

- A USB flash drive with maximum 64 GB storage capacity and file system FAT32 must be available.

Procedure:

1. Create an "UPDATE" folder on the USB stick.
2. Save the update file with the required firmware in the "UPDATE" folder on the USB flash drive. The update file is, for example, available for download on the product page of the inverter at www.SMA-Solar.com. Ensure that only the update file to which the inverter is to be updated must be stored on the USB flash drive.

3.  **DANGER**

Danger to life due to high voltages

- Disconnect the inverter from all voltage sources and open the enclosure lid of the DC connection unit (see Section 9, page 88).

4. Insert the USB flash drive in the USB port on the communication assembly.
5. Commission the inverter (see Section 7.2, page 55).

- During start-up phase of the inverter, the desired firmware is being installed.

6.  **DANGER**

Danger to life due to high voltages

- Disconnect the inverter from all voltage sources and open the enclosure lid of the DC connection unit (see Section 9, page 88).

7. Pull the USB flash drive out of the USB port.
8. Commission the inverter (see Section 7.2, page 55).

9. Open the user interface and check the events to see whether the firmware update has been completed successfully.
10. If the firmware update has not been successfully completed, perform the firmware update again.

8.26.4 Searching for and Installing New Firmware via the User Interface

QUALIFIED PERSON

Requirement:

- The inverter must be connected to the Internet.

Procedure:

1. Open the user interface (see Section 8.2, page 60).
 2. Log into the user interface as an **Installer** (see Section 8.3, page 64).
 3. Click on [**Edit parameters**].
 4. Go to **Device > Update**.
 5. Select the parameter **Check for update and install it** and set it to **Execute**.
 6. Click on [**Save all**].
- The firmware is updated in the background.

9 Disconnecting the Inverter from Voltage Sources

⚠ QUALIFIED PERSON

Prior to performing any work on the product, always disconnect it from all voltage sources as described in this section. Always adhere to the prescribed sequence.

⚠ WARNING

Danger to life due to electric shock from destruction of the measuring device due to overvoltage

Overvoltage can damage a measuring device and result in voltage being present in the enclosure of the measuring device. Touching the live enclosure of the measuring device results in death or lethal injuries due to electric shock.

- Only use measuring devices with a DC input voltage range of 1000 V or higher.

Procedure:

1. Disconnect the AC miniature circuit breaker and secure against reconnection.
2. Turn the DC load-break switch of the inverter to position **O**.
3. Secure the DC load-break switch against reconnection using a suitable padlock.
4. If the multifunction relay is used, switch off any supply voltage to the load.
5. Wait until the LEDs have gone out.
6. Use a current clamp to ensure that no current is present in the DC cables.

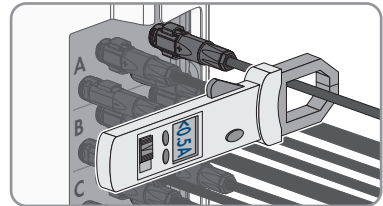

7. Note the position of the DC connector.

8.

⚠ DANGER

Danger to life due to electric shock when touching exposed DC conductors or DC plug contacts if the DC connectors are damaged or loose

The DC connectors can break or become damaged, become free of the DC cables, or no longer be connected correctly if the DC connectors are released and disconnected incorrectly. This can result in the DC conductors or DC plug contacts being exposed. Touching live DC conductors or DC plug connectors will result in death or serious injury due to electric shock.

- Wear insulated gloves and use insulated tools when working on the DC connectors.
- Ensure that the DC connectors are in perfect condition and that none of the DC conductors or DC plug contacts are exposed.
- Carefully release and remove the DC connectors as described in the following.

9. Release and remove the DC connectors. To do so, insert a flat-blade screwdriver or an angled screwdriver (blade width: 3.5 mm) into one of the side slots and pull the DC connectors out. When doing so, do not lever the DC connectors out, but insert the tool into one of the side slots only to release the locking mechanism, and do not pull on the cable.

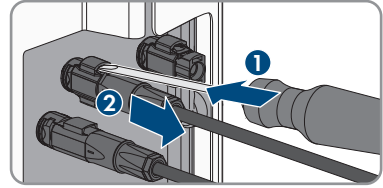

10. Ensure that the DC connectors on the product and those that are equipped with DC conductors are in perfect condition and that none of the DC conductors or DC plug contacts are exposed.
11. Ensure that no voltage is present at the DC inputs on the inverter using a suitable measuring device.

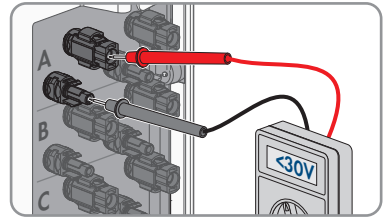

12. Unscrew (TX25) all 10 screws of the enclosure lid of the AC-Connection Unit and remove the enclosure lid carefully towards the front.

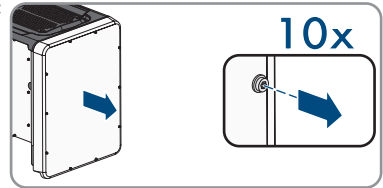

13. Set the screws and the enclosure lid aside and store safely.
14. Ensure there is no voltage on the AC terminal block between L1 and N, L2 and N, and L3 and N using a suitable measuring device. To do so, insert the test probe (maximum diameter: 2.5 mm) into the measuring points of the respective terminal blocks.
15. Ensure that there is no voltage on the AC terminal block between L1 and grounding conductor, L2 and grounding conductor, and L3 and grounding conductor using a suitable measuring device. To do so, insert the test probe (maximum diameter: 2.5 mm) into the measuring points of the respective terminal blocks.

10 Clean the product

NOTICE

Damage to the product due to cleaning agents

The use of cleaning agents may cause damage to the product and its components.

- Clean the product and all its components only with a cloth moistened with clear water.

Procedure:

- Ensure that the product is free of dust, foliage and other dirt.

11 Troubleshooting

11.1 Forgotten Password

i Password assignment for inverters that are registered in a communication product

The password for the user group **Installer** is also the system password for the system in the communication product. Changing the password of the user group **Installer** can lead to the inverter no longer being able to be reached by the communication product.

- In the communication product, assign the changed password of the user group **Installer** as the new system password (see the manual of the communication product).

If you have forgotten the password for the inverter, you can unlock the inverter with a Personal Unlocking Key (PUK). For each inverter, there is 1 PUK for each user group (**User** and **Installer**).
Tipp: With PV systems that are registered in a communication product, you can also assign a new password for the user group **Installer** via the communication product. The password for the user group **Installer** is the same as the system password in the communication product.

Procedure:

1. Request PUK (application form available at www.SMA-Solar.com).
2. Open the user interface (see Section 8.2, page 60).
3. Enter the PUK instead of the password into the field **Password**.
4. Select **Login**.
5. Call up the menu **Device parameters**.
6. Click on [**Edit parameters**].
7. In the parameter group **User Rights > Access Control** change the password of the desired user group.
8. Select [**Save all**] to save the changes.

11.2 Event Messages

Event number	Message, cause and corrective measures
101	<p data-bbox="311 236 594 268">⚠ QUALIFIED PERSON</p> <p data-bbox="288 284 426 309">Grid incident</p> <p data-bbox="288 320 983 376">The grid voltage or grid impedance at the connection point of the inverter is too high. The inverter has disconnected from the utility grid.</p> <p data-bbox="288 384 508 410">Corrective measures:</p> <ul data-bbox="311 419 992 655" style="list-style-type: none"> <li data-bbox="311 419 992 592">• Check whether the grid voltage at the connection point of the inverter is permanently in the permissible range. If the grid voltage is outside the permissible range due to local grid conditions, contact the grid operator. The grid operator must agree with an adjustment of the voltage at the feed-in point or with a change of the monitored operating limits. If the grid voltage is permanently within the permissible range and this message is still displayed, contact the Service.
301	<p data-bbox="311 675 594 707">⚠ QUALIFIED PERSON</p> <p data-bbox="288 722 426 748">Grid incident</p> <p data-bbox="288 759 995 871">The ten-minute average value of the grid voltage is no longer within the permissible range. The grid voltage or grid impedance at the connection point is too high. The inverter disconnects from the utility grid to maintain power quality.</p> <p data-bbox="288 879 508 904">Corrective measures:</p> <ul data-bbox="311 914 992 1150" style="list-style-type: none"> <li data-bbox="311 914 992 1150">• During the feed-in operation, check whether the grid voltage at the connection point of the inverter is permanently in the permissible range. If the grid voltage is outside the permissible range due to local grid conditions, contact the grid operator. The grid operator must agree with an adjustment of the voltage at the feed-in point or with a change of the monitored operating limits. If the grid voltage is permanently within the permissible range and this message is still displayed, contact the Service.
401	<p data-bbox="311 1173 594 1204">⚠ QUALIFIED PERSON</p> <p data-bbox="288 1220 426 1246">Grid incident</p> <p data-bbox="288 1257 1006 1313">The inverter has disconnected from the utility grid. A stand-alone grid or a very large change in the grid frequency was detected.</p> <p data-bbox="288 1321 508 1347">Corrective measures:</p> <ul data-bbox="311 1356 1009 1382" style="list-style-type: none"> <li data-bbox="311 1356 1009 1382">• Check the grid connection for significant short-term frequency fluctuations.

Event number	Message, cause and corrective measures
501	<p data-bbox="311 188 595 220">⚠ QUALIFIED PERSON</p> <p data-bbox="288 236 425 263">Grid incident</p> <p data-bbox="288 272 992 327">The power frequency is not within the permissible range. The inverter has disconnected from the utility grid.</p> <p data-bbox="288 336 508 363">Corrective measures:</p> <ul data-bbox="311 368 907 422" style="list-style-type: none"> <li data-bbox="311 368 907 422">• If possible, check the power frequency and observe how often fluctuations occur. <p data-bbox="333 432 995 518">If fluctuations occur frequently and this message is displayed often, contact the grid operator and request approval to change the operating parameters of the inverter.</p> <p data-bbox="333 528 938 582">If the grid operator gives his approval, discuss any changes to the operating parameters with the Service.</p>
601	<p data-bbox="311 595 595 627">⚠ QUALIFIED PERSON</p> <p data-bbox="288 643 425 670">Grid incident</p> <p data-bbox="288 679 978 734">The inverter has detected an excessively high proportion of direct current in the grid current.</p> <p data-bbox="288 743 508 770">Corrective measures:</p> <ul data-bbox="311 775 967 861" style="list-style-type: none"> <li data-bbox="311 775 736 802">• Check the grid connection for direct current. <li data-bbox="311 812 967 861">• If this message is displayed frequently, contact the grid operator and check whether the monitoring threshold on the inverter can be raised.
801	<p data-bbox="311 882 595 914">⚠ QUALIFIED PERSON</p> <p data-bbox="288 930 960 957">Waiting for grid voltage > Grid failure > Check AC circuit breaker</p> <p data-bbox="288 967 1006 1021">The AC cable is not correctly connected or the country data set is not correctly configured.</p> <p data-bbox="288 1031 508 1058">Corrective measures:</p> <ul data-bbox="311 1062 990 1252" style="list-style-type: none"> <li data-bbox="311 1062 835 1090">• Ensure that the miniature circuit breaker is switched on. <li data-bbox="311 1099 931 1153">• Ensure that the AC cable is not damaged and that it is connected correctly. <li data-bbox="311 1163 907 1190">• Ensure that the country data set has been configured correctly. <li data-bbox="311 1200 990 1252">• Check whether the grid voltage at the connection point of the inverter is permanently in the permissible range. <p data-bbox="333 1262 992 1374">If the grid voltage is outside the permissible range due to local grid conditions, contact the grid operator. The grid operator must agree with an adjustment of the voltage at the feed-in point or with a change of the monitored operating limits.</p> <p data-bbox="333 1383 976 1437">If the grid voltage is permanently within the permissible range and this message is still displayed, contact the Service.</p>

Event number	Message, cause and corrective measures
901	<p data-bbox="311 188 596 220">⚠ QUALIFIED PERSON</p> <p data-bbox="288 236 807 260">Grounding connection missing > Check connection</p> <p data-bbox="288 272 766 296">The grounding conductor is not correctly connected.</p> <p data-bbox="288 309 508 333">Corrective measures:</p> <ul data-bbox="311 341 878 365" style="list-style-type: none"> <li data-bbox="311 341 878 365">• Ensure that the grounding conductor is correctly connected.
3401 3402 3404 3407 3410 3411 3412	<p data-bbox="311 387 596 419">⚠ QUALIFIED PERSON</p> <p data-bbox="288 435 686 459">DC overvoltage > Disconnect PV array</p> <p data-bbox="288 472 822 496">Overvoltage at the DC input. This can destroy the inverter.</p> <p data-bbox="288 509 917 533">This message is signalized additionally by rapid flashing of the LEDs.</p> <p data-bbox="288 545 508 569">Corrective measures:</p> <ul data-bbox="311 577 997 818" style="list-style-type: none"> <li data-bbox="311 577 904 601">• Immediately disconnect the inverter from all voltage sources. <li data-bbox="311 614 997 695">• Check whether the DC voltage is below the maximum input voltage of the inverter. If the DC voltage is below the maximum input voltage of the inverter, reconnect the DC connectors to the inverter. <li data-bbox="311 708 992 790">• If the DC voltage exceeds the maximum input voltage of the inverter, ensure that the PV array has been correctly rated or contact the installer of the PV array. <li data-bbox="311 802 829 818">• If this message is repeated frequently, contact Service.
3501	<p data-bbox="311 834 596 866">⚠ QUALIFIED PERSON</p> <p data-bbox="288 882 659 906">Insulation failure > Check generator</p> <p data-bbox="288 919 813 943">The inverter has detected a ground fault in the PV system.</p> <p data-bbox="288 956 508 979">Corrective measures:</p> <ul data-bbox="311 987 686 1011" style="list-style-type: none"> <li data-bbox="311 987 686 1011">• Check the PV system for ground faults.
3701	<p data-bbox="311 1034 596 1066">⚠ QUALIFIED PERSON</p> <p data-bbox="288 1082 732 1106">Residual current too high > Check PV array</p> <p data-bbox="288 1118 997 1174">The inverter has detected a residual current through brief grounding of the PV array.</p> <p data-bbox="288 1187 508 1211">Corrective measures:</p> <ul data-bbox="311 1219 686 1243" style="list-style-type: none"> <li data-bbox="311 1219 686 1243">• Check the PV system for ground faults.

Event number	Message, cause and corrective measures
3801 3802 3803 3805 3806 3807 3808	<p>⚠ QUALIFIED PERSON</p> <p>DC overcurrent > Check PV array</p> <p>Overcurrent at the DC input. The inverter briefly interrupts feed-in operation.</p> <p>Corrective measures:</p> <ul style="list-style-type: none"> • If this message is displayed frequently, ensure that the PV array has been correctly rated and wired.
4301 4302	<p>⚠ QUALIFIED PERSON</p> <p>Electric arc detected</p> <p>The arc-fault circuit interrupter has detected an electric arc. If the arc-fault circuit interrupter is activated using operation inhibition, the operation inhibition function must be reset manually.</p>
6002-6412	<p>⚠ QUALIFIED PERSON</p> <p>Self-diagnosis > Device disturbance</p> <p>The cause must be determined by the Service.</p> <p>Corrective measures:</p> <ul style="list-style-type: none"> • Contact the Service.
6502	<p>⚠ QUALIFIED PERSON</p> <p>Self-diagnosis > Overtemperature</p> <p>The inverter has switched off due to excessive temperature.</p> <p>Corrective measures:</p> <ul style="list-style-type: none"> • Clean the cooling fins on the rear of the enclosure and the air ducts on the top using a soft brush. • Ensure that the inverter has sufficient ventilation. • Ensure that the inverter is not exposed to direct solar irradiation.
6512	<p>Minimum operating temperature not reached</p> <p>The inverter will only recommence grid feed-in once the temperature has reached at least -25°C.</p>
6603 6604	<p>⚠ QUALIFIED PERSON</p> <p>Self-diagnosis > Overload</p> <p>The cause must be determined by the Service.</p> <p>Corrective measures:</p> <ul style="list-style-type: none"> • Contact the Service.

Event number	Message, cause and corrective measures
6701 6702	<p data-bbox="314 188 596 220">⚠ QUALIFIED PERSON</p> <p data-bbox="292 236 524 261">Communication failure</p> <p data-bbox="292 272 986 325">Error in the communication processor, the inverter continues feeding in, however. The cause must be determined by the Service.</p> <p data-bbox="292 336 508 362">Corrective measures:</p> <ul data-bbox="311 371 871 397" style="list-style-type: none"> <li data-bbox="311 371 871 397">• If this message is displayed frequently, contact the Service.
7102	<p data-bbox="314 414 596 446">⚠ QUALIFIED PERSON</p> <p data-bbox="292 462 667 488">Parameter file not found or defective</p> <p data-bbox="292 499 978 552">The parameter file was not found or is defective. Loading the parameter file has failed. The inverter continues to feed in.</p> <p data-bbox="292 563 508 588">Corrective measures:</p> <ul data-bbox="311 598 804 624" style="list-style-type: none"> <li data-bbox="311 598 804 624">• Copy the parameter file to the correct folder again.
7105	<p data-bbox="314 641 596 673">⚠ QUALIFIED PERSON</p> <p data-bbox="292 689 538 715">Parameter setting failed</p> <p data-bbox="292 726 992 778">Parameters could not be set using the memory card. The inverter continues to feed in.</p> <p data-bbox="292 790 508 815">Corrective measures:</p> <ul data-bbox="311 825 781 882" style="list-style-type: none"> <li data-bbox="311 825 781 850">• Ensure that the parameters are set correctly. <li data-bbox="311 860 781 882">• Ensure that you have an SMA Grid Guard code.
7106	<p data-bbox="292 896 505 922">Update file defective</p> <p data-bbox="292 933 986 986">The update file is defective. The update failed. The inverter continues to feed in.</p>
7110	<p data-bbox="292 1000 505 1026">No update file found</p> <p data-bbox="292 1037 972 1090">No new update file was found on the SD memory card. The update failed. The inverter continues to feed in.</p>
7112	Update file successfully copied
7113	The memory card is full or write-protected
7201	Data storage not possible
7202	Data storage not possible
7303	<p data-bbox="314 1251 596 1283">⚠ QUALIFIED PERSON</p> <p data-bbox="292 1299 583 1324">Host computer update failed</p> <p data-bbox="292 1335 708 1361">The cause must be determined by the Service.</p> <p data-bbox="292 1372 508 1398">Corrective measures:</p> <ul data-bbox="311 1407 519 1433" style="list-style-type: none"> <li data-bbox="311 1407 519 1433">• Contact the Service.

Event number	Message, cause and corrective measures
7320	<p>The device was successfully updated The firmware update was completed successfully.</p>
7330	<p>Condition test failed The testing of the update conditions was not successful. The firmware update package is not suitable for this inverter.</p>
7331	<p>Update transport started Update file is being copied.</p>
7332	<p>Update transport successful Update file was copied successfully to the inverter's internal memory.</p>
7333	<p>⚠ QUALIFIED PERSON</p> <p>Update transport failed Update file could not be copied to the inverter's internal memory. In the event of connection with the inverter via Wi-Fi network, a poor connection quality can be the cause.</p> <p>Corrective measures:</p> <ul style="list-style-type: none"> • Retry update. • For Wi-Fi connection: Improve the Wi-Fi connection quality (e.g. via Wi-Fi repeater) or establish connection with the inverter via Ethernet. • If this message is displayed again, contact the Service.
7341	<p>Update Bootloader The inverter is performing a bootloader update.</p>
7342	<p>⚠ QUALIFIED PERSON</p> <p>Update Bootloader failed The bootloader update failed.</p> <p>Corrective measures:</p> <ul style="list-style-type: none"> • Retry update. • If this message is displayed again, contact the Service.
7347	<p>⚠ QUALIFIED PERSON</p> <p>Incompatible file The configuration file is not suitable for this inverter.</p> <p>Corrective measures:</p> <ul style="list-style-type: none"> • Ensure that the selected configuration file is suitable for this inverter. • Retry import.

Event number	Message, cause and corrective measures
7348	<p data-bbox="292 177 596 220">⚠ QUALIFIED PERSON</p> <p data-bbox="292 236 493 261">Incorrect file format</p> <p data-bbox="292 272 885 298">The configuration file is not of the required format or is damaged.</p> <p data-bbox="292 309 508 335">Corrective measures:</p> <ul data-bbox="311 344 997 430" style="list-style-type: none"> <li data-bbox="311 344 997 400">• Ensure that the selected configuration file is of the required format and is not damaged. <li data-bbox="311 405 452 430">• Retry import.
7350	<p data-bbox="292 435 721 477">Transfer of a configuration file has started</p> <p data-bbox="292 480 670 505">The configuration file is being transferred.</p>
7351	<p data-bbox="292 512 426 553">Update Wi-Fi</p> <p data-bbox="292 557 670 582">The inverter is updating the Wi-Fi module.</p>
7352	<p data-bbox="292 588 598 630">Update of Wi-Fi not successful</p> <p data-bbox="292 633 641 659">The update of the Wi-Fi module failed.</p> <p data-bbox="292 670 508 695">Corrective measures:</p> <ul data-bbox="311 705 833 762" style="list-style-type: none"> <li data-bbox="311 705 460 730">• Retry update. <li data-bbox="311 735 833 762">• If this message is displayed again, contact the Service.
7353	<p data-bbox="292 767 577 809">Update time zone database</p> <p data-bbox="292 812 731 837">The inverter is updating the time zone database.</p>
7354	<p data-bbox="292 844 596 885">⚠ QUALIFIED PERSON</p> <p data-bbox="292 901 751 927">Update of time zone database not successful</p> <p data-bbox="292 938 703 963">The update of the time zone database failed.</p> <p data-bbox="292 975 508 1000">Corrective measures:</p> <ul data-bbox="311 1010 833 1067" style="list-style-type: none"> <li data-bbox="311 1010 460 1035">• Retry update. <li data-bbox="311 1040 833 1067">• If this message is displayed again, contact the Service.
7355	<p data-bbox="292 1074 449 1115">Update WebUI</p> <p data-bbox="292 1118 745 1144">The inverter is updating the inverter user interface.</p>
7356	<p data-bbox="292 1150 596 1192">⚠ QUALIFIED PERSON</p> <p data-bbox="292 1208 658 1233">Update of the WebUI not successful</p> <p data-bbox="292 1244 717 1270">The update of the inverter user interface failed.</p> <p data-bbox="292 1281 508 1307">Corrective measures:</p> <ul data-bbox="311 1316 833 1374" style="list-style-type: none"> <li data-bbox="311 1316 460 1342">• Retry update. <li data-bbox="311 1347 833 1374">• If this message is displayed again, contact the Service.

Event number	Message, cause and corrective measures
7619	<p data-bbox="311 188 595 220">⚠ QUALIFIED PERSON</p> <p data-bbox="288 236 1001 260">Communication fault with meter unit > Check communication to meter</p> <p data-bbox="288 272 840 296">The inverter is not receiving any data from the energy meter.</p> <p data-bbox="288 309 508 333">Corrective measures:</p> <ul data-bbox="311 341 1012 483" style="list-style-type: none"> <li data-bbox="311 341 1012 397">• Ensure that the energy meter is correctly integrated into the same network as the inverter (see energy meter manual). <li data-bbox="311 405 1012 483">• For Wi-Fi connection: Improve the Wi-Fi connection quality (e.g., via Wi-Fi repeater) or connect the inverter with the DHCP server (router) via Ethernet.
7622	<p data-bbox="288 501 701 525">No communication with the I/O module</p> <p data-bbox="288 537 990 619">This event is displayed during a device-internal communication error with the SMA I/O Module. The inverter will disconnect from the utility grid for safety reasons.</p>
7702	<p data-bbox="311 638 595 670">⚠ QUALIFIED PERSON</p> <p data-bbox="288 686 414 710">Device fault</p> <p data-bbox="288 722 710 746">The cause must be determined by the Service.</p> <p data-bbox="288 759 508 783">Corrective measures:</p> <ul data-bbox="311 791 519 815" style="list-style-type: none"> <li data-bbox="311 791 519 815">• Contact the Service.
7801	<p data-bbox="311 833 595 865">⚠ QUALIFIED PERSON</p> <p data-bbox="288 880 573 904">Fault overvoltage protector</p> <p data-bbox="288 917 994 971">One or more surge arresters have tripped or one or more surge arresters are not inserted correctly.</p> <p data-bbox="288 984 508 1008">Corrective measures:</p> <ul data-bbox="311 1016 981 1106" style="list-style-type: none"> <li data-bbox="311 1016 788 1040">• Ensure that the surge arrester is inserted correctly. <li data-bbox="311 1048 981 1106">• If surge arresters have tripped, replace the tripped surge arresters with new surge arresters.
8003	<p data-bbox="311 1123 595 1155">⚠ QUALIFIED PERSON</p> <p data-bbox="288 1171 613 1195">Active power limit Temperature</p> <p data-bbox="288 1208 1003 1262">The inverter has reduced its power output for more than 10 minutes due to excessive temperature.</p> <p data-bbox="288 1275 508 1299">Corrective measures:</p> <ul data-bbox="311 1307 981 1460" style="list-style-type: none"> <li data-bbox="311 1307 981 1361">• Clean the cooling fins on the rear of the enclosure and the air ducts on the top using a soft brush. <li data-bbox="311 1369 770 1393">• Ensure that the inverter has sufficient ventilation. <li data-bbox="311 1401 967 1425">• Ensure that the ambient temperature +35°C has not been exceeded. <li data-bbox="311 1433 918 1460">• Ensure that the inverter is not exposed to direct solar irradiation.

Event number	Message, cause and corrective measures
8101 8102 8103 8104	<p data-bbox="292 181 596 220">⚠ QUALIFIED PERSON</p> <p data-bbox="292 236 524 260">Communication failure</p> <p data-bbox="292 272 708 296">The cause must be determined by the Service.</p> <p data-bbox="292 309 508 333">Corrective measures:</p> <ul data-bbox="311 341 519 365" style="list-style-type: none"> <li data-bbox="311 341 519 365">• Contact the Service.
8208	<p data-bbox="292 381 596 419">⚠ QUALIFIED PERSON</p> <p data-bbox="292 432 874 456">Self-test for arc fault detection: interference level too high</p> <p data-bbox="292 469 1001 525">An error has occurred during the self-test of the arc-fault circuit interrupter. The cause must be determined by the Service.</p> <p data-bbox="292 533 508 557">Corrective measures:</p> <ul data-bbox="311 564 519 588" style="list-style-type: none"> <li data-bbox="311 564 519 588">• Contact the Service.
8209	<p data-bbox="292 606 596 644">⚠ QUALIFIED PERSON</p> <p data-bbox="292 657 869 681">Self-test for arc fault detection: interference level too low</p> <p data-bbox="292 694 1001 750">An error has occurred during the self-test of the arc-fault circuit interrupter. The cause must be determined by the Service.</p> <p data-bbox="292 758 508 782">Corrective measures:</p> <ul data-bbox="311 790 519 813" style="list-style-type: none"> <li data-bbox="311 790 519 813">• Contact the Service.
9002	<p data-bbox="292 831 596 869">⚠ QUALIFIED PERSON</p> <p data-bbox="292 882 598 906">SMA Grid Guard code invalid</p> <p data-bbox="292 919 1009 975">The SMA Grid Guard code entered is incorrect. The operating parameters are still protected and cannot be changed.</p> <p data-bbox="292 983 508 1007">Corrective measures:</p> <ul data-bbox="311 1015 710 1038" style="list-style-type: none"> <li data-bbox="311 1015 710 1038">• Enter the correct SMA Grid Guard code.
9003	<p data-bbox="292 1056 538 1080">Grid parameters locked</p> <p data-bbox="292 1093 1009 1177">Changes to the grid parameters are now blocked. In order to be able to make changes to the grid parameters, from now on you must log in using the SMA Grid Guard code.</p>

Event number	Message, cause and corrective measures
9005	<p data-bbox="311 183 593 215">⚠ QUALIFIED PERSON</p> <p data-bbox="288 231 924 263">Changing of grid parameters not possible > Ensure DC supply</p> <p data-bbox="288 271 666 295">This error can have the following causes:</p> <ul data-bbox="311 303 957 367" style="list-style-type: none"> <li data-bbox="311 303 756 327">• The parameters to be changed are protected. <li data-bbox="311 335 957 367">• The DC voltage at the DC input is not sufficient to run the main CPU. <p data-bbox="288 375 509 399">Corrective measures:</p> <ul data-bbox="311 406 935 494" style="list-style-type: none"> <li data-bbox="311 406 644 430">• Enter the SMA Grid Guard code. <li data-bbox="311 438 935 494">• Ensure that at least the DC start voltage is available (green LED is flashing, pulsing or glowing).
9007	<p data-bbox="311 510 593 542">⚠ QUALIFIED PERSON</p> <p data-bbox="288 558 431 582">Abort self-test</p> <p data-bbox="288 590 649 614">The self-test (Italy only) was terminated.</p> <p data-bbox="288 630 509 654">Corrective measures:</p> <ul data-bbox="311 662 705 726" style="list-style-type: none"> <li data-bbox="311 662 705 686">• Ensure that the AC connection is correct. <li data-bbox="311 694 509 726">• Restart the self-test.
9033	<p data-bbox="288 742 610 766">Rapid Shutdown was triggered</p> <p data-bbox="288 774 991 829">The inverter detected the triggering of a Rapid Shutdown. The AC side of the inverter was disconnected.</p>
9034	<p data-bbox="311 845 593 877">⚠ QUALIFIED PERSON</p> <p data-bbox="288 893 621 917">Error in Rapid Shutdown System</p> <p data-bbox="288 933 700 957">This message can have the following causes:</p> <ul data-bbox="311 965 980 1117" style="list-style-type: none"> <li data-bbox="311 965 879 989">• The Rapid Shutdown Function was not correctly configured. <li data-bbox="311 997 935 1053">• The PV array could not be correctly disconnected. Voltage can be applied to the DC inputs of the inverter. <li data-bbox="311 1061 980 1117">• The standby voltage of all PV array disconnect switches of a string is > 30 V. <p data-bbox="288 1125 509 1149">Corrective measures:</p> <ul data-bbox="311 1157 1002 1372" style="list-style-type: none"> <li data-bbox="311 1157 1002 1244">• Check the configuration of the Rapid Shutdown function and ensure that the operating mode selected is selected according to the DC disconnection unit used. <li data-bbox="311 1252 879 1276">• Check the functionality of the PV array disconnect switches. <li data-bbox="311 1284 1002 1372">• Check the standby voltage of the PV array disconnect switches used and ensure that the standby voltage of all PV array disconnect switches of a string < 30 V.

Event number	Message, cause and corrective measures
9035	<p>Rapid Shutdown successful</p> <p>The voltage at the DC inputs and at the AC output of the inverter was successfully discharged.</p>
9037	<p>⚠ QUALIFIED PERSON</p> <p>Generator connection not carried out</p> <p>The PV array disconnect switches did not connect the PV generator.</p> <p>Corrective measures:</p> <ul style="list-style-type: none"> • Check the functionality of the SunSpec-compliant PV array disconnect switches.
9038	<p>⚠ QUALIFIED PERSON</p> <p>Redundant Rapid Shutdown discharge function not ensured</p> <p>The cause must be determined by the Service.</p> <p>Corrective measures:</p> <ul style="list-style-type: none"> • Contact the Service.
10108	<p>Time adjusted / old time</p>
10109	<p>Time adjusted / new time</p>
10110	<p>⚠ QUALIFIED PERSON</p> <p>Time synchronization failed: [xx]</p> <p>No time information could be called up from the set NTP server.</p> <p>Corrective measures:</p> <ul style="list-style-type: none"> • Ensure that the NTP server was configured correctly. • Ensure that the inverter is integrated into a local network with Internet connection.
10118	<p>Parameter upload complete</p> <p>The configuration file was loaded successfully.</p>
10248	<p>⚠ QUALIFIED PERSON</p> <p>[Interface]: network busy</p> <p>The network is busy. Data exchange between the devices is not at an optimum and is greatly delayed.</p> <p>Corrective measures:</p> <ul style="list-style-type: none"> • Increase the query intervals. • If necessary, reduce the number of devices in the network.

Event number	Message, cause and corrective measures
10249	<p data-bbox="311 188 595 220">⚠ QUALIFIED PERSON</p> <p data-bbox="288 236 622 263">[Interface]: network overloaded</p> <p data-bbox="288 272 986 300">The network is overloaded. There is no data exchange between the devices.</p> <p data-bbox="288 309 508 336">Corrective measures:</p> <ul data-bbox="311 344 759 400" style="list-style-type: none"> <li data-bbox="311 344 759 371">• Reduce the number of devices in the network. <li data-bbox="311 376 759 400">• If necessary, increase the data query intervals.
10250	<p data-bbox="311 419 595 451">⚠ QUALIFIED PERSON</p> <p data-bbox="288 467 723 494">[Interface]: package error rate [ok / high]</p> <p data-bbox="288 504 1005 587">The package error rate has changed. If the package error rate is high, the network is overloaded or the connection to the network switch or DHCP server (router) is impaired.</p> <p data-bbox="288 596 837 624">Corrective measures if the package error rate is high:</p> <ul data-bbox="311 632 1009 783" style="list-style-type: none"> <li data-bbox="311 632 1009 719">• Ensure that with an Ethernet connection, the network cable and the network connector are not damaged and that the network connectors are correctly plugged. <li data-bbox="311 724 759 751">• If necessary, increase the data query intervals. <li data-bbox="311 756 865 783">• If necessary, reduce the number of devices in the network.
10251	<p data-bbox="288 802 967 850">[Interface]: communication status goes to [OK / Warning / Error / Not connected]</p> <p data-bbox="288 863 983 911">The communication status to the network switch or DHCP server (router) has changed. An additional error message may be displayed.</p>
10252	<p data-bbox="311 930 595 962">⚠ QUALIFIED PERSON</p> <p data-bbox="288 978 669 1005">[Interface]: communication disrupted</p> <p data-bbox="288 1015 686 1042">There is no valid signal on the network line.</p> <p data-bbox="288 1051 508 1078">Corrective measures:</p> <ul data-bbox="311 1086 1009 1238" style="list-style-type: none"> <li data-bbox="311 1086 1009 1174">• Ensure that with an Ethernet connection, the network cable and the network connector are not damaged and that the network connectors are correctly plugged. <li data-bbox="311 1179 947 1238">• Ensure that the DHCP server (router) and any network switches are signaling correct operation.

Event number	Message, cause and corrective measures
10253	<p>⚠ QUALIFIED PERSON</p> <p>[Interface]: connection speed goes to [100 Mbit / 10 Mbit]</p> <p>The data transfer rate has changed. The cause for the status [10 Mbit] can be a defective plug, a defective cable or the pulling or plugging of the network connector.</p> <p>Corrective measures if the status is [10 Mbit]:</p> <ul style="list-style-type: none"> • Ensure that with an Ethernet connection, the network cable and the network connector are not damaged and that the network connectors are correctly plugged. • Ensure that the DHCP server (router) and any network switches are signaling correct operation.
10254	<p>⚠ QUALIFIED PERSON</p> <p>[Interface]: duplex mode goes to [Full / Half]</p> <p>The duplex mode (data transfer mode) has changed. The cause for the status [Half] can be a defective plug, a defective cable or the pulling or plugging of the network connector.</p> <p>Corrective measures if the status is [Half]:</p> <ul style="list-style-type: none"> • Ensure that with an Ethernet connection, the network cable and the network connector are not damaged and that the network connectors are correctly plugged. • Ensure that the DHCP server (router) and any network switches are signaling correct operation.
10255	<p>⚠ QUALIFIED PERSON</p> <p>[Interface]: Network load OK</p> <p>The network load has returned to a normal range after being busy.</p>
10282	<p>[User group]-Login via [protocol] locked</p> <p>After several incorrect login attempts, login has been blocked for a limited time. In this case, the User login will be blocked for 15 minutes, the Grid Guard login for 12 hours.</p> <p>Corrective measures:</p> <ul style="list-style-type: none"> • Wait until the given time has expired and then retry login.
10283	<p>⚠ QUALIFIED PERSON</p> <p>Wi-Fi module faulty</p> <p>The Wi-Fi module integrated in the inverter is defective.</p> <p>Corrective measures:</p> <ul style="list-style-type: none"> • Contact the Service.

Event number	Message, cause and corrective measures
10284	<p>⚠ QUALIFIED PERSON</p> <p>No Wi-Fi connection possible</p> <p>The inverter does not currently have a Wi-Fi connection to the selected network.</p> <p>Corrective measures:</p> <ul style="list-style-type: none"> • Ensure that the SSID, the Wi-Fi password and the encryption method have been entered correctly. The encryption method is specified by your Wi-Fi router or Wi-Fi access point and can be changed there. • Ensure that the Wi-Fi router or Wi-Fi access point is in range and is signaling correct operation. • If this message is displayed often, improve the Wi-Fi connection by using a Wi-Fi repeater.
10285	<p>Wi-Fi connection established</p> <p>Connection to the selected Wi-Fi network has been established.</p>
10286	<p>⚠ QUALIFIED PERSON</p> <p>Wi-Fi connection lost</p> <p>The inverter has lost Wi-Fi connection to the selected network.</p> <p>Corrective measures:</p> <ul style="list-style-type: none"> • Ensure that the Wi-Fi router or Wi-Fi access point is still active. • Ensure that the Wi-Fi router or Wi-Fi access point is in range and is signaling correct operation. • If this message is displayed often, improve the Wi-Fi connection by using a Wi-Fi repeater.
10339	Webconnect enabled
10340	Webconnect disabled
10431	I-V curve measurement successfully carried out
10502	Active power limit AC frequency
10513	<p>Grid management service Fast stop: Stop by system control is executed</p> <p>This event is generated by the monitoring relay of the monitoring unit when the grid and PV system protection device is triggered. The inverter disconnects from the utility grid.</p>
10901	Start self-test xx
10902	Current disconnection limit for voltage increase protection xxx V
10903	Current disconnection limit for voltage monitoring lower maximum threshold xxx V

Event number	Message, cause and corrective measures
10904	Current disconnection limit for voltage monitoring upper minimum threshold xxx V
10905	Current disconnection limit for voltage monitoring middle minimum threshold xxx V
10906	Current disconnection limit for frequency monitoring switchable maximum threshold xxx Hz
10907	Current disconnection limit for frequency monitoring switchable minimum threshold xxx Hz
10908	Current disconnection limit for frequency monitoring lower maximum threshold xxx Hz
10909	Current disconnection limit for frequency monitoring upper minimum threshold xxx Hz
10910	Measured disconnection threshold for the running test point xxx xx
10911	Standard value for the running test point xxx xx
10912	Measured disconnection time for the running test point xx s
27103	Set parameter The parameter changes are being adopted.
27104	Parameters set successfully The parameter changes were successfully adopted.
27107	Update file OK The update file found is valid.
27301	Update communication The inverter is updating the communication component.
27302	Update main CPU The inverter is updating the inverter component.
27312	Update completed The inverter has successfully completed the update.
29001	Inst. code valid The entered Grid Guard code is valid. Protected parameters have now been unlocked and you can adjust the parameters. The parameters will be automatically locked again after 10 feed-in hours.
29004	Grid parameter unchanged Changing the grid parameters is not possible.

11.3 Checking the PV System for Ground Faults

QUALIFIED PERSON

If the red LED is glowing and the event number 3501, 3601 or 3701 is being displayed in the **Results** menu on the inverter user interface, there may be a ground fault present. The electrical insulation from the PV system to ground is defective or insufficient.

DANGER

Danger to life due to electric shock when touching live system components in case of a ground fault

If a ground fault occurs, parts of the system may still be live. Touching live parts and cables results in death or lethal injuries due to electric shock.

- Disconnect the product from voltage sources and ensure it cannot be reconnected before working on the device.
- Only touch the cables of the PV modules on their insulation.
- Do not touch any parts of the substructure or frame of the PV array.
- Do not connect PV strings with ground faults to the inverter.

WARNING

Danger to life due to electric shock from destruction of the measuring device due to overvoltage

Overvoltage can damage a measuring device and result in voltage being present in the enclosure of the measuring device. Touching the live enclosure of the measuring device results in death or lethal injuries due to electric shock.

- Only use measuring devices with a DC input voltage range of 1000 V or higher.

Procedure:

In order to check the PV system for ground faults, perform the following actions in the prescribed order. The exact procedure is described in the following sections.

- Check the PV system for ground faults by measuring the voltage.
- If the voltage measurement was not successful, check the PV system via insulation resistance measurement for ground faults.

Test by Measuring the Voltage

Proceed as follows to check each string in the PV system for ground faults.

Procedure:

1.

DANGER

Danger to life due to high voltages

- Disconnect the inverter from all voltage sources (see Section 9, page 88).

2. Measure the voltages:

- Measure the voltage between the positive terminal and the ground potential (PE).
 - Measure the voltage between the negative terminal and the ground potential (PE).
 - Measure the voltage between the positive and negative terminals.
- If the following results are present at the same time, there is a ground fault in the PV system:

- All measured voltages are stable.
- The sum of the two voltages to ground potential is approximately equal to the voltage between the positive and negative terminals.

3. If a ground fault is present, determine the location of the ground fault via the ratio of the two measured voltages and eliminate the ground fault.
4. If a definite ground fault cannot be measured and the message is still displayed, measure the insulation resistance.
5. Reconnect the strings without ground faults to the inverter and recommission the inverter (see inverter installation inverter).



Location of the ground fault

The example shows a ground fault between the second and third PV module.

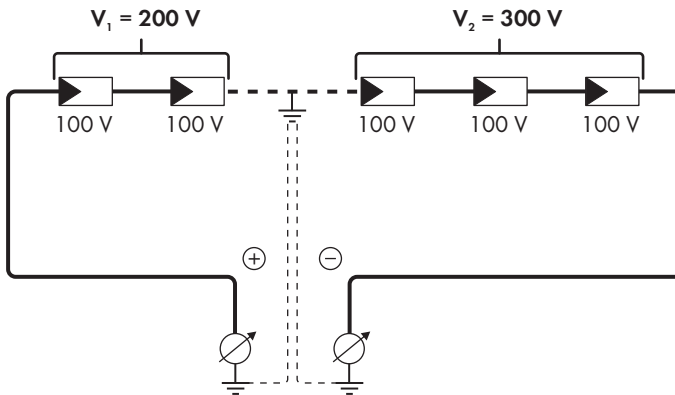

Test by Measuring the Insulation Resistance

If the voltage measurement does not provide sufficient evidence of a ground fault, the insulation resistance measurement can provide more exact results.

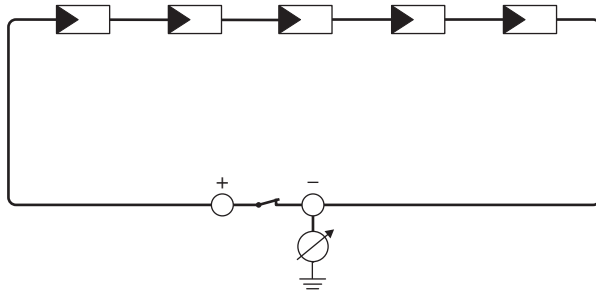

Figure 19: Schematic diagram of the measurement

i Calculating the insulation resistance

The expected total resistance of the PV system or of an individual string can be calculated using the following formula:

$$\frac{1}{R_{\text{total}}} = \frac{1}{R_1} + \frac{1}{R_2} + \frac{1}{R_3} + \dots$$

The exact insulation resistance of a PV module can be obtained from the module manufacturer or the datasheet.

For the resistance of a PV module an average value can be assumed: for thin-film PV modules approximately 40 MOhm and for polycrystalline and monocrystalline PV modules approximately 50 MOhm per PV module (for further information on calculating the insulation resistance see the Technical Information "Insulation Resistance (Riso) of Non-Galvanically Isolated PV Systems" at www.SMA-Solar.com).

Required devices:

- Suitable device for safe disconnection and short-circuiting
- Measuring device for insulation resistance

i Device required for safe disconnection and short-circuiting of the PV array

The insulation resistance can only be measured with a suitable device for safe disconnection and short-circuiting of the PV array. If no suitable device is available, the insulation measurement must not be carried out.

Procedure:

1. Calculate the expected insulation resistance per string.

2.

⚠ DANGER

Danger to life due to high voltages

- Disconnect the inverter from all voltage sources (see Section 9, page 88).

3. Install the short circuit device.
4. Connect the measuring device for insulation resistance.
5. Short-circuit the first string.

6. Set the test voltage. The test voltage should be as close as possible to the maximum system voltage of the PV modules but must not exceed it (see datasheet of the PV modules).
7. Measure the insulation resistance.
8. Eliminate the short circuit.
9. Measure the remaining strings in the same manner.
 - If the insulation resistance of a string deviates considerably from the theoretically calculated value, there is a ground fault present in that string.
10. Reconnect to the inverter only those strings from which the ground fault has been eliminated.
11. Reconnect all other strings to the inverter.
12. Recommission the inverter.
13. If the inverter still displays an insulation error, contact the Service (see Section 1.5, page 120). The PV modules might not be suitable for the inverter in the present quantity.

11.4 Resetting the Operation Inhibition after Detection of an Arc Fault

QUALIFIED PERSON

If the red LED is glowing and the event number **4301** or **4302** is shown in the event list on the user interface of the inverter, the inverter has detected an electric arc and interrupts feed-in operation.

Procedure:

1.

 **DANGER**

Danger to life due to electric shock

- Disconnect the inverter from any voltage sources (see the inverter installation manual).

2. Ensure that the PV modules, the connected DC cables and the terminal block for the DC connection are not defective.
Repair or replace defective PV modules, DC cables or terminal block for the DC connection.
 3. Recommission the inverter (see inverter installation manual).
 4. Activate the user interface (see Section 8.2, page 60).
 5. Log into the user interface as an **Installer** (see Section 8.3, page 64).
 6. Reset the operation inhibition by setting one of the following parameters:
 - Select the parameter **Reset operating data** and set to **Reset operation inhibition**.
 - or**
 - Select the parameter **AFCI switched on** and set to **No** and then back to **Yes**.
- This effects resetting of the operation inhibition and the inverter will start feeding in again.

12 Decommissioning the Inverter

⚠ QUALIFIED PERSON

To decommission the inverter completely upon completion of its service life, proceed as described in this Section.

⚠ CAUTION

Risk of injury when lifting the inverter, or if it is dropped

The inverter weighs 84 kg. You risk injury if you lift the inverter incorrectly or if it is dropped while being transported or mounted.

- Carry and lift the inverter in an upright position with several people without tilting it.

Requirements:

- A pallet must be available.
- Original packaging with paddings must be available.
- All transport handles must be in place.

Procedure:

1.

⚠ DANGER

Danger to life due to high voltages

- Disconnect the inverter from all voltage sources (see Section 9, page 88).

2.

⚠ CAUTION

Risk of burns due to hot enclosure parts

- Wait 30 minutes for the enclosure to cool down.

3. Remove the AC cable from the inverter. To do so, loosen the screws (AF8) and pull the cables out of the terminal.

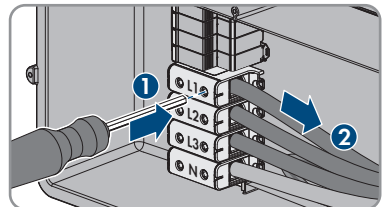

4. Disconnect the grounding conductor from the grounding terminal. Loosen the screws (TX 25) and pull the grounding conductor out under the clip.

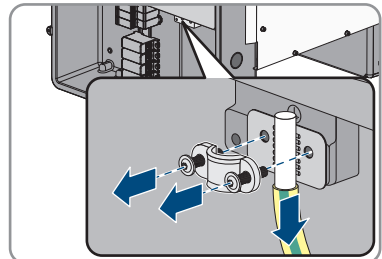

5. Remove the AC cable from the inverter.
6. Remove the M63 cable gland from the enclosure opening in the AC connection unit. To do so, remove the inside counter nut and remove the cable gland from the enclosure opening.
7. When the AC surge arresters are inserted, pull the surge arresters out of the slots. To do so, squeeze the grooved areas on the left and right sides of the surge arrester.

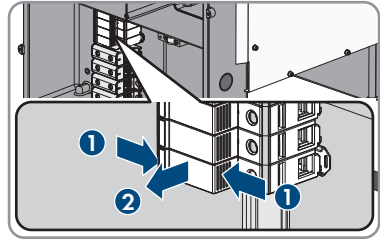

8. Position the enclosure lid of the AC-Connection Unit on the AC-Connection Unit and first tighten the upper-left and lower-right screws, and then the remaining screws crosswise (TX 25, torque: 6 Nm).

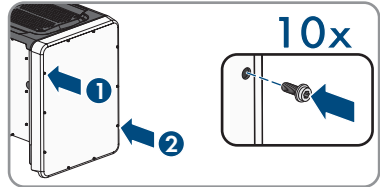

9. Unscrew (TX25) all ten screws of the enclosure lid of the DC-Connection Unit and remove the enclosure lid carefully towards the front.

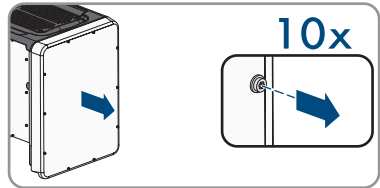

10. Set the screws and the enclosure lid aside and store safely.
11. Remove all connection cables from the communication assembly and pull out the connection cables out of the DC-Connection Unit.

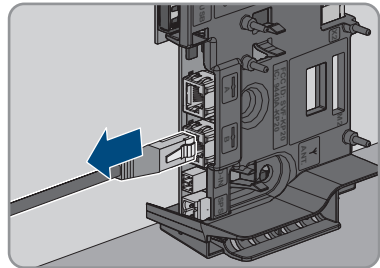

12. Remove all cable glands from the inverter. To do so, unscrew the counter nut from inside and remove the cable gland from the enclosure opening.

13. When the DC surge arresters are inserted, pull the surge arresters out of the slots. To do so, squeeze the grooved areas on the left and right sides of the surge arrester.

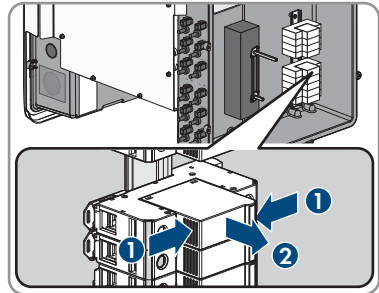

14. Position the enclosure lid of the DC-Connection Unit on the DC-Connection Unit and first tighten the upper-left and lower-right screws, and then the remaining screws crosswise (TX 25, torque: 6 Nm).

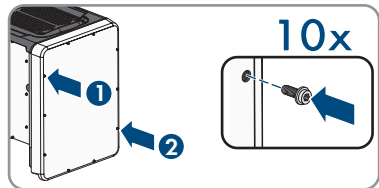

15. Screw all four transport handles as far as they will go into the taps on the right- and left-hand side until they lie flush with the enclosure. When doing so, ensure that the transport handles are screwed into the taps so that they are perfectly straight. If the transport handles are not screwed in straight, this can make it more difficult or even impossible to unscrew them later on and can damage the taps to the extent that transport handles can no longer be screwed into them.

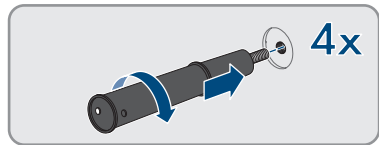

16. Insert a screwdriver into the holes in the transport handle and turn the screwdriver through 90°. This ensures that the transport handles are securely tightened.

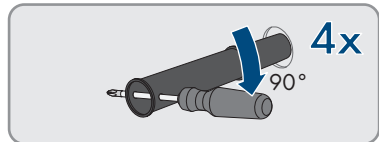

17. To remove the feet or profile rails, lay the inverter carefully on the AC-Connection Unit side.
18. If the inverter is to be stored or shipped, pack the inverter in its original packaging.
- Place the lower part of the original packaging with padding on the pallet
 - Place the inverter with padding on the pallet. For this purpose, put the AC-Connection Unit side of the inverter on top of the padding.

- Remove all four transport handles from the threaded holes. If necessary, insert a screwdriver into the holes on the transport handle and use the screwdriver to remove the transport handle.

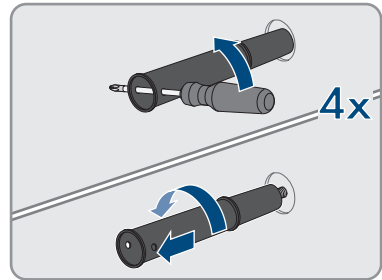

- Pull the upper part of the original packaging over the inverter.
 - Insert the upper padding.
 - Close the packaging.
 - Secure the packaging and pallet with strapping or with fastening belts.
19. Dispose of the inverter in accordance with the locally applicable disposal regulations for electronic waste.

13 Technical Data

DC Input

Maximum power of PV array	75000 W _p STC
Maximum input voltage	1000 V
MPP voltage range	500 V to 800 V
Rated input voltage	670 V
Minimum input voltage	150 V
Initial input voltage	188 V
Maximum input current per DC connector	20 A
Maximum input current per input	20 A
Maximum short-circuit current per input*	30 A
Maximum reverse current into the PV modules	0 A
Number of independent MPP inputs	6
Strings per MPP input	2
Surge category in accordance with IEC 62109-1	II

* In accordance with IEC 62109-2: $I_{SC PV}$

AC Output

Rated power at 230 V, 50 Hz	50000 W
Maximum apparent power	50000 VA
Rated apparent power	50000 VA
Nominal grid voltage	400 V / 230 V
Rated grid voltage	230 V
Voltage range*	202 V to 264 V
Rated current at 230 V	72.5 A
Maximum output current	72.5 A
Maximum output current under fault conditions	86 A
Total harmonic distortion of the output current with total harmonic distortion of the AC voltage <2%, and AC power >50% of the rated power	< 2 %
Inrush current	< 10% of the nominal AC current for a maximum of 10 ms
Rated grid frequency	50 Hz

-Grid frequency*	50 Hz / 60 Hz
Operating range at grid frequency 50 Hz	44 Hz to 55 Hz
Operating range at grid frequency 60 Hz	54 Hz to 65 Hz
Power factor at rated power	1
Displacement power factor, adjustable	0.0 overexcited to 0.0 underexcited
Feed-in phases	3
Connection phases	3 (+1)
Surge category in accordance with IEC 62109-1	III

* Depending on the configured country data set

Multifunction relay

Maximum DC switching voltage	30 V
Maximum AC switching current	1.0 A
Maximum DC switching current	1.0 A
Minimum load	0.1 W
Minimum electrical endurance when the maximum switching voltage and maximum switching current are complied with*	100000 switching cycles

* Corresponds to 20 years at 12 switching operations per day

Efficiency

Maximum efficiency, η_{\max}	> 98.1 %
European weighted efficiency, η_{EU}	> 97.8 %

Protective devices

DC reverse polarity protection	Short-circuit diode
Input-side disconnection point	DC load-break switch*
DC overvoltage protection	Surge arrester type 1 and 2 (optional)
AC short-circuit current capability	Current control
Grid monitoring	SMA Grid Guard 10.0
Maximal output overcurrent protection	100 A
Ground fault monitoring	Insulation monitoring: $R_{\text{iso}} > 34 \text{ k}\Omega$
All-pole sensitive residual-current monitoring unit	Available
Active anti-islanding method	Frequency shift

* Usage category according to IEC 60947: DC-PV2

General data

Width x height x depth, without feet or DC load-break switch	569 mm x 733 mm x 621 mm
Weight	84 kg
Length x width x height of the packaging	800 mm x 600 mm x 886 mm
Transport weight	100 kg
Climatic category in accordance with IEC 60721-3-4	4K4H
Environmental category	outdoors
Pollution degree of all enclosure parts	2
Operating temperature range	-25 °C to +60 °C
Max. permissible value for relative humidity (condensing)	100 %
Maximum operating altitude above mean sea level (MSL)	3000 m
Typical noise emission	64 dB(A)
Power loss in night mode	5 W
Power control / Demand response (DRED)	Communication via Modbus interface
Export limiting in accordance with AS/NZS 4777.2	EDMM-10 with compatible Modbus counting device (Janitza UMG 604-PRO)
Demand response mode in accordance with AS/NZS 4777.2	DRM0
Topology	Transformerless (Non-isolated)
Cooling method	SMA OptiCool
Number of fans	3
Degree of protection for electronics in accordance with IEC 60529	IP65
Protection class in accordance with IEC 62109-1	I
Radio technology	WLAN 802.11 b/g/n
Radio spectrum	2.4 GHz
Maximum transmission power	100 mW
Wi-Fi range in free-field conditions	100 m
Quantity maximum detectable Wi-Fi networks	32
Grid configurations	TN-C, TN-S, TN-C-S, TT (when $V_{N,PE} < 20$ V)

Climatic Conditions

Installation in accordance with IEC 60721-3-4, Class 4K4H

Extended temperature range	-25 °C to +60 °C
Extended humidity range	0% to 100%
Threshold for relative humidity, non-condensing	100 %
Extended air pressure range	79.5 kPa to 106 kPa

Transport in accordance with IEC 60721-3-4, Class 2K3

Temperature range	-40 °C to +70 °C
-------------------	------------------

Equipment

DC terminal	SUNCLIX DC connector
AC terminal	Screw terminals
Multifunction relay	As standard
Surge protection devices Type II for AC and/or DC	Optional

Torques

Screws for the DC-Connection Unit and AC-Connection Unit enclosure lids	6 Nm
Screws for AC terminals with conductor cross-section of 35 mm ² to 95 mm ²	20 Nm
Screws for AC terminals with conductor cross-section of 120 mm ²	30 Nm
Screws for attaching the feet or profile rails	16 Nm
Screws for the cover on the top of the inverter	6 Nm
Counter nut of M63 cable gland	14 Nm
Swivel nut for M63 cable gland	33 Nm
Swivel nut for M32 cable gland	5 Nm
SUNCLIX swivel nut	2 Nm

Data Storage Capacity

Daily energy yields	63 days
Daily yields	30 years
Event messages for users	1024 events
Event messages for installers	1024 events

14 Accessories

You will find the accessories for your product in the following overview. If required, these can be ordered from SMA Solar Technology AG or your distributor.

Designation	Short designation	SMA order number
SMA Antenna Extension Kit	Accessory set for one SMA inverter for the optimization of the SMA inverter's WLAN radio range.	EXTANT-40
SMA Sensor Module	Interface for one SMA inverter as retrofit kit for capturing environmental data (e.g. solar irradiation, ambient temperature, cell temperature, wind speed or SO meters).	MD.SEN-40
Universal mounting system	For wall mounting or as a platform for higher mounting of the inverter on the ground	UMS_KIT-10
SMA 485 Module	Interface for establishing cable-bound communication via RS485	MD.485-40
SMA I/O modules	Interface to implement grid management services and/or grid and PV system protection	MD.IO-40
AC overvoltage protection elements	Surge protection devices Type II for AC side	AC_SPD_Kit1-10
DC overvoltage protection elements	Surge protection devices Type II for DC side	DC_SPD_Kit4-10

15 Contact

If you have technical problems with our products, please contact the SMA Service Line. The following data is required in order to provide you with the necessary assistance:

- Device type
- Serial number
- Firmware version
- Event message
- Mounting location and mounting height
- Type and number of PV modules
- Optional equipment, e.g. communication products
- Use the name of the system in Sunny Portal (if available)
- Access data for Sunny Portal (if available)
- Special country-specific settings (if available)
- Operating mode of the multifunction relay

You can find your country's contact information at:



<https://go.sma.de/service>

16 EU Declaration of Conformity

within the scope of the EU directives

- Radio Equipment Directive 2014/53/EU (22.5.2014 L 153/62) (RED)
- Restriction of the use of certain hazardous substances 2011/65/EU (L 174/88, June 8, 2011) and 2015/863/EU (L 137/10, March 31, 2015) (RoHS)



SMA Solar Technology AG confirms herewith that the products described in this document are in compliance with the fundamental requirements and other relevant provisions of the above-mentioned directives. The entire EU Declaration of Conformity can be found at www.SMA-Solar.com.

17 UK Declaration of Conformity

according to the regulations of England, Wales and Scotland

- Electromagnetic Compatibility Regulations 2016 (SI 2016/1091)
- Electrical Equipment (Safety) Regulations 2016 (SI 2016/1101)
- Radio Equipment Regulations 2017 (SI 2017/1206)
- The Restriction of the Use of Certain Hazardous Substances in Electrical and Electronic Equipment Regulations 2012



SMA Solar Technology AG confirms herewith that the products described in this document are in compliance with the fundamental requirements and other relevant provisions of the above-mentioned regulations. The entire UK Declaration of Conformity can be found at www.SMA-Solar.com.



www.SMA-Solar.com

